



ECLB60W 49.5-60 Watt Isolated DC-DC Converters

Application Note V14

ISOLATED DC-DC CONVERTER ECLB60W SERIES APPLICATION NOTE



Approved By:

Department	Approved By	Checked By	Written By
Research and Development Department	Jacky	Astray	Joe
Design Quality Department	Benny	JoJo	



ECLB60W 49.5-60 Watt Isolated DC-DC Converters

Application Note V14

Contents

1. Introduction	3
2. Pin Function Description	3
3. Connection for Standard Use	4
4. Test Set-Up	4
5. Recommend Layout, PCB Footprint and Soldering Information.....	5
6. Features and Functions	5
6.1 UVLO (Under Voltage Lock Out)	5
6.2 Over Current / Short Circuit Protection	5
6.3 Output Over Voltage Protection	6
6.4 Over Temperature Protection.....	6
6.5 Remote On/Off	6
6.6 Output Voltage Adjustment	7
7. Input / Output Considerations	8
7.1 Input Capacitance at the Power Module	8
7.2 Output Ripple and Noise	9
7.3 Output Capacitance	9
8. Thermal Design.....	10
8.1 Operating Temperature Range	10
8.2 Convection Requirements for Cooling	10
8.3 Thermal Considerations	10
8.4 Power Derating	10
8.5 LB Heat Sinks:	12
9. Safety & EMC	13
9.1 Input Fusing and Safety Considerations	13
9.2 EMC Considerations	13



ECLB60W 49.5-60 Watt Isolated DC-DC Converters

Application Note V14

1. Introduction

The ECLB60W series of DC-DC converters offers 60 watts of output power single and dual output voltages of 3.3, 5, 12, 15, ± 12 , ± 15 VDC with standard 2"X1" pin out. It has a wide (4:1) input voltage range of 9 to 36VDC (24VDC nominal) and 18 to 75VDC (48VDC nominal). Apart from, it has 1500VDC isolation (input to output).

Compliant with EN55022, EN55032. High efficiency up to 92%, allowing case operating temperature range of -40°C to 105°C (except M2 Series -55°C to 105°C). An optional heat sink is available to extend the full power range of the unit. Very low no load power consumption, an ideal solution for energy critical systems.

The standard control functions include remote on/off (positive or negative) and $\pm 10\%$ adjustable output voltage.

Fully protected against input UVLO (under voltage lock out), output over-current, output over-voltage and over-temperature and continuous short circuit conditions.

ECLB60W series is designed primarily for common applications of 12V, 24V, 48V nominal voltage and also suitable for distributed power architectures, telecommunications, battery operated equipment and industrial applications.

2. Pin Function Description

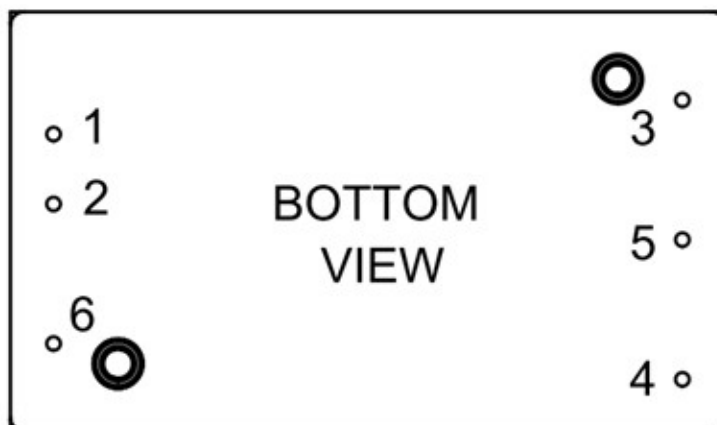

Single Output

No	Label	Function	Description	Reference
1	+Vin	+V Input	Positive Supply Input	Section 7.1
2	-Vin	-V Input	Negative Supply Input	Section 7.1
3	+Vout	+V Output	Positive Power Output	Section 7.2/7.3
4	Trim	Trim	External Output Voltage Adjustment	Section 6.6
5	-Vout	-V Output	Negative Power Output	Section 7.2/7.3
6	Remote	Remote On/Off	External Remote On/Off Control	Section 6.5

Dual Output

No	Label	Function	Description	Reference
1	+Vin	+V Input	Positive Supply Input	Section 7.1
2	-Vin	-V Input	Negative Supply Input	Section 7.1
3	+Vout	+V Output	Positive Power Output	Section 7.2/7.3
4	-Vout	-V Output	Negative Power Output	Section 7.2/7.3
5	Com	Common	Common Power Output	Section 7.2/7.3
6	Remote	Remote On/Off	External Remote On/Off Control	Section 6.5



ECLB60W 49.5-60 Watt Isolated DC-DC Converters

Application Note V14

3. Connection for Standard Use

The connection for standard use is shown below. An external input capacitor (C1) for all models is recommended to reduce input ripple voltage. External output capacitors (C2 or C2') are recommended to reduce output ripple and noise, 1uF ceramic capacitor for other models

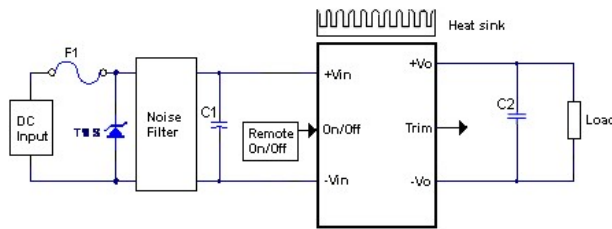

ECLB60W-XXSXX

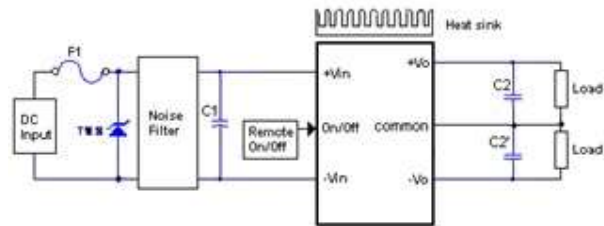

ECLB60W-XXDXX

Symbol	Component	Reference
F1, TVS	Input fuse, TVS	Section 9.1
C1	External capacitor on input side	Note Section 7.1
C2, C2'	External capacitor on the output side	Section 7.3
Noise Filter	External input noise filter	Section 9.2
Remote On/Off	External remote on/off control	Section 6.5
Trim	External output voltage adjustment	Section 6.6
Heat sink	External heat sink	Section 8.1/8.2/8.3/8.4/8.5

Note:

If the impedance of input line is high, C1 capacitance must be more than above. Use more than two recommended capacitor above in parallel when ambient temperature becomes lower than -20°C.

4. Test Set-Up

The basic test set-up to measure parameters such as efficiency and load regulation is shown below. When testing the modules under any transient conditions please ensure that the transient response of the source is sufficient to power the equipment under test. We can calculate:

- Efficiency
- Load regulation and line regulation

The value of efficiency is defined as:

$$\eta = \frac{V_o \times I_o}{V_{in} \times I_{in}} \times 100\%$$

Where:

- V_o is output voltage
- I_o is output current
- V_{in} is input voltage
- I_{in} is input current

The value of load regulation is defined as:

$$Load\ reg. = \frac{V_{FL} - V_{NL}}{V_{NL}} \times 100\%$$

Where:

- V_{FL} is the output voltage at full load
- V_{NL} is the output voltage at no load

The value of line regulation is defined as:

$$Line\ reg. = \frac{V_{HL} - V_{LL}}{V_{LL}} \times 100\%$$

Where:

- V_{HL} is the output voltage of maximum input voltage at full load
- V_{LL} is the output voltage of minimum input voltage at full load

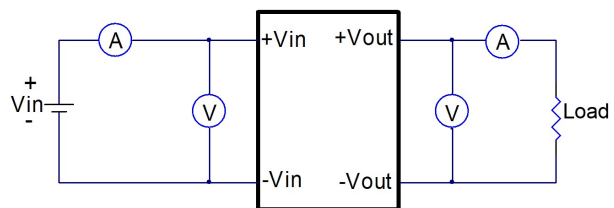

ECLB60W Series Test Setup



ECLB60W 49.5-60 Watt Isolated DC-DC Converters

Application Note V14

5. Recommend Layout, PCB Footprint and Soldering Information

The system designer or end user must ensure that metal and other components in the vicinity of the converter meet the spacing requirements for which the system is approved. Low resistance and inductance PCB layout traces are the norm and should be used where possible. Due consideration must also be given to proper low impedance tracks between power module, input and output grounds. The recommended footprints and soldering profiles are shown below.

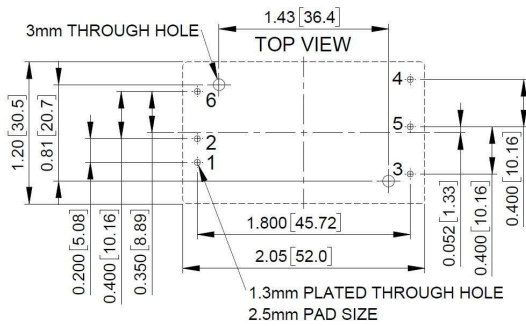

Note: Dimensions are in inches (millimeters)

Clean the soldered side of the module with a brush, prevent liquid from getting into the module. Do not clean by soaking the module into liquid. Do not allow solvent to come in contact with product labels or resin case as this may change the color of the resin case or cause deletion of the letters printed on the product label. After cleaning, dry the modules well.

The suggested soldering iron is $420 \pm 10^\circ\text{C}$ for up to 4~15seconds (less than 90W). Furthermore, the recommended soldering profile is shown below.

Lead Free Wave Soldering Profile

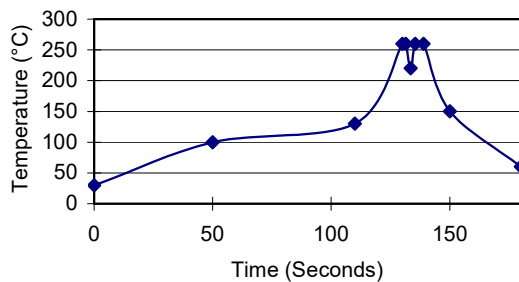

6. Features and Functions

6.1 UVLO (Under Voltage Lock Out)

Input under voltage lockout is standard on the ECLB60W series unit. The unit will shut down when the input voltage drops below a threshold, and the unit will operate when the input voltage goes above the upper threshold.

ECLB60W-24Vin

lin Vs Vin

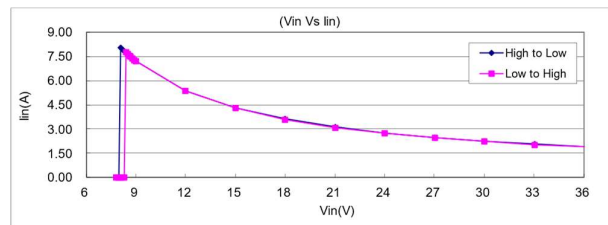

ECLB60W-48 Vin

lin Vs Vin

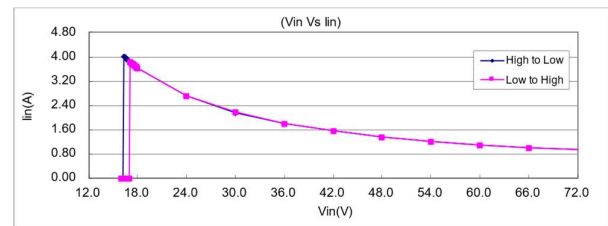

6.2 Over Current / Short Circuit Protection

All models have internal over current and continuous short circuit protection. The unit operates normally once the fault condition is removed. At the point of current limit inception, the converter will go into hiccup mode protection.

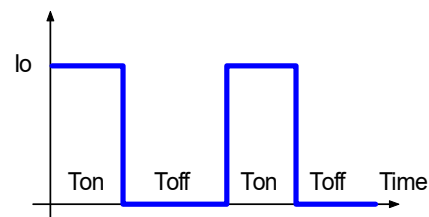
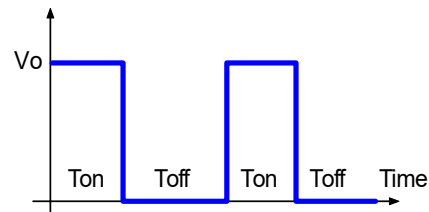



ECLB60W 49.5-60 Watt Isolated DC-DC Converters

Application Note V14

6.3 Output Over Voltage Protection

The over-voltage protection consists of a zener diode to limiting the out voltage.

6.4 Over Temperature Protection

These modules have an over temperature protection circuit to safeguard against thermal damage. Shutdown occurs with the maximum case reference temperature is exceeded. The module will restart when the case temperature falls below over temperature recovery threshold. Different input voltage the over temperature protection turn on/off points will drift. Please measure temperature of the center part of metal case.

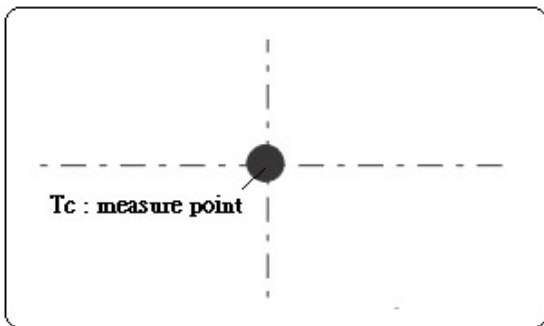
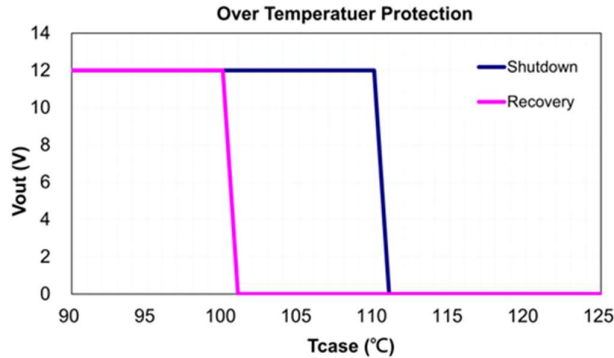

6.5 Remote On/Off

The ECLB60W series allows the user to switch the module on and off electronically with the remote on/off feature. All models are available in "positive logic" and "negative logic" (optional) versions. The converter turns on if the remote On/Off pin is high (>3.5Vdc to 75Vdc or open circuit). Setting the pin low (0 to <1.2Vdc, except M2 Series is 0 to <1.0Vdc) will turn the converter off. The signal level of the remote on/off input is defined with respect to ground.

If not using the remote on/off pin, leave the pin open (converter will be on). Converter will be turn on in positive mode.

Models with part number suffix "N" are the "negative logic" remote on/off version. The unit turns off if the remote on/off pin is high (>3.5Vdc to 75Vdc or open circuit). The converter turns on if the On/Off pin input is low (0 to <1.2Vdc, except M2 Series is 0 to <1.0Vdc). Note that the converter is off by default.

Logic State (Pin 6)	Negative Logic	Positive Logic
Logic Low	Module on	Module off
Logic High	Module off	Module on

The converter remote on/off circuit built-in on input side. The ground pin of input side remote on/off circuit is -vin pin. Inside connection sees below.

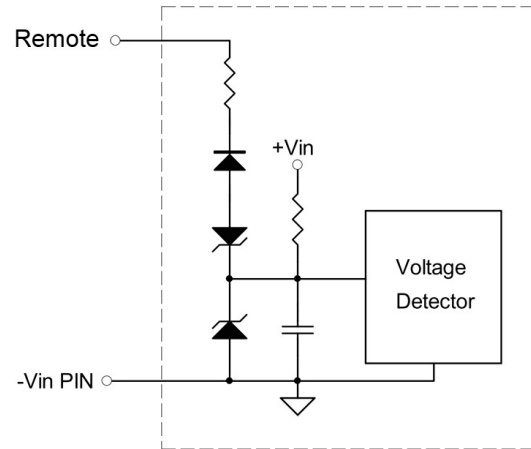

Connection examples see below.

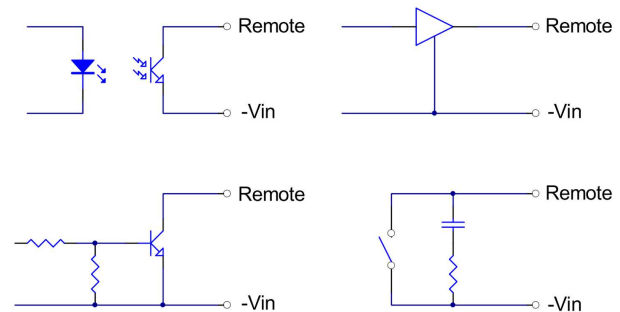

Remote On/Off Connection Examples



ECLB60W 49.5-60 Watt Isolated DC-DC Converters

Application Note V14

6.6 Output Voltage Adjustment

Output may be externally trimmed $\pm 10\%$ with a fixed resistor or an external trim pot as shown (optional). Model specific formulas for calculating trim resistors are available upon request as a separate document.

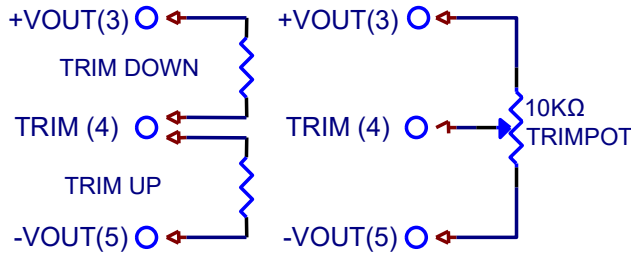

In order to trim the voltage up or down, one needs to connect the trim resistor either between the trim pin and -Vout for trim-up or between trim pin and +Vout for trim-down. The output voltage trim range is $\pm 10\%$. (Single output models only) This is shown:

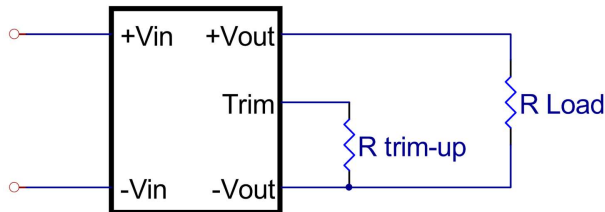

Trim-up Voltage Setup

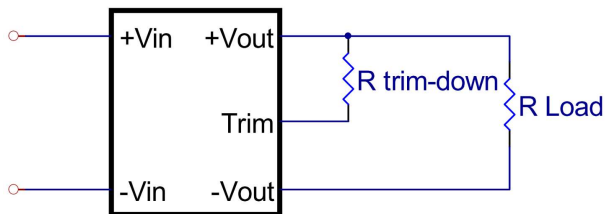

Trim-down Voltage Setup

1. The value of Rtrim-up defined as:

The ECLB60W-XXSXX value of Rtrim-up defined as:

$$R_{trim-up} = \left(\frac{V_r \times R_1 \times (R_2 + R_3)}{(V_o - V_{o,nom}) \times R_2} \right) - R_t \text{ (K}\Omega\text{)}$$

Where

R trim-up is the external resistor in Kohm.

V_{o, nom} is the nominal output voltage.

V_o is the desired output voltage.

R1, R_t, R2, R3 and Vr are internal to the unit and are defined in Table 1.

Table 1 – Trim up and Trim down Resistor Values

Model Number	Output Voltage(V)	R1 (KΩ)	R2 (KΩ)	R3 (KΩ)	Rt (KΩ)	Vr (V)
ECLB60W-XXS33	3.3	2.74	1.8	0.27	9.1	1.24
ECLB60W-XXS05	5.0	2.32	2.32	0	8.2	2.5
ECLB60W-XXS12	12.0	6.8	2.4	2.32	22	2.5
ECLB60W-XXS15	15.0	8.06	2.4	3.9	27	2.5

For example, to trim-up the output voltage of 5.0V module (ECLB60W-24S05) by 10% to 5.5V, R trim-up is calculated as follows:

$$V_o - V_{o,nom} = 5.5 - 5.0 = 0.5V$$

$$R_1 = 2.32 \text{ K}\Omega$$

$$R_2 = 2.32 \text{ K}\Omega$$

$$R_3 = 0 \text{ K}\Omega$$

$$R_t = 8.2 \text{ K}\Omega$$

$$V_r = 2.5 \text{ V}$$

$$R_{trim-up} = \left(\frac{2.5 \times 2.32 \times (2.32 + 0)}{0.5 \times 2.32} \right) - 8.2 = 3.4(\text{K}\Omega)$$

The typical value of Rtrim-up

Trim up %	3.3V	5V	12V	15V
	Rtrim-up (KΩ)			
1%	109.3	107.8	256.6	325.6
2%	50.10	49.80	117.3	149.3
3%	30.36	30.46	70.87	90.50
4%	20.50	20.80	47.65	61.15
5%	14.58	15.00	33.72	43.52
6%	10.63	11.13	24.43	31.77
7%	7.81	8.37	17.80	23.38
8%	5.70	6.30	12.82	17.07
9%	4.05	4.68	8.90	12.18
10%	2.74	3.40	5.86	8.26



ECLB60W 49.5-60 Watt Isolated DC-DC Converters

Application Note V14

2.The value of R trim-down defined as:

The ECLB60W-XXSXX value of R_{trim-down} defined as:

$$R_{trim-down} = R1 \times \left(\frac{Vr \times R1}{(V_{o,nom} - V_o) \times R2} - 1 \right) - Rt \quad (K\Omega)$$

Where

R_{trim-down} is the external resistor in Kohm.

V_{O,nom} is the nominal output voltage.

V_O is the desired output voltage.

R1, Rt, R2, R3 and Vr are internal to the unit and are defined in Table 1.

For example, to trim-down the output voltage of 5.0V module (ECLB60W-24S05) by 10% to 4.5V, R trim-down is calculated as follows:

$$V_{O,nom} - V_o = 5.0 - 4.0 = 1.0V$$

$$R1 = 2.32 \text{ K}\Omega$$

$$R2 = 2.32 \text{ K}\Omega$$

$$R3 = 0 \text{ K}\Omega$$

$$Rt = 8.2 \text{ K}\Omega$$

$$Vr = 2.5 \text{ V}$$

$$R_{trim-down} = 2.32 \times \left(\frac{(2.5 \times 2.32)}{0.5 \times 2.32} - 1 \right) - 8.2 = 1.08 \text{ (K}\Omega)$$

The typical value of R_{trim-down}

Trim down %	3.3V	5V	12V	15V
	R _{trim-down} (KΩ)			
1%	144.8	104.5	385.4	433.9
2%	66.52	46.58	184.7	208.4
3%	40.40	27.24	117.8	133.2
4%	27.34	17.58	84.44	95.62
5%	19.50	11.78	64.37	73.06
6%	14.28	7.91	50.99	58.03
7%	10.54	5.15	41.44	47.28
8%	7.75	3.08	34.27	39.23
9%	5.57	1.46	28.69	32.96
10%	3.83	0.18	24.23	27.95

7. Input / Output Considerations

7.1 Input Capacitance at the Power Module

The converters must be connected to low AC source impedance. To avoid problems with loop stability source inductance should be low. Also, the input capacitors (Cin) should be placed close to the converter input pins to de-couple distribution inductance. However, the external input capacitors are chosen for suitable ripple handling capability. Low ESR capacitors are good choice. Circuit as shown as below represents typical measurement methods for reflected ripple current. C1 and L1 simulate a typical DC source impedance. The input reflected-ripple current is measured by current probe to oscilloscope with a simulated source Inductance (L1).

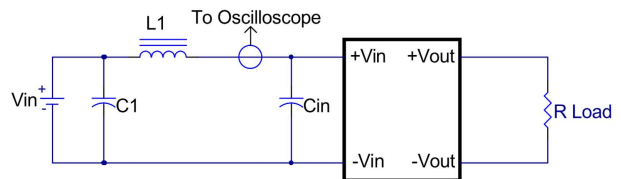

L1: 1.2uH

C1: None

Cin: 330uF ESR<0.7ohm @100KHz



ECLB60W 49.5-60 Watt Isolated DC-DC Converters

Application Note V14

7.2 Output Ripple and Noise

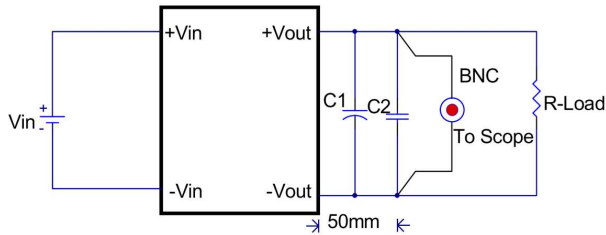

Note: C1: None, C2: 1uF ceramic capacitor.
ECLB60W single output module

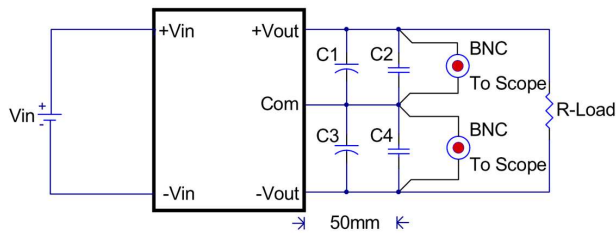

Note: C1 & C3: None, C2 & C4: 1uF ceramic capacitor.
ECLB60W dual output module

Output ripple and noise measured with 1uF ceramic capacitor across output, A 20 MHz bandwidth oscilloscope is normally used for the measurement.

The conventional ground clip on an oscilloscope probe should never be used in this kind of measurement. This clip, when placed in a field of radiated high frequency energy, acts as an antenna or inductive pickup loop, creating an extraneous voltage that is not part of the output noise of the converter.

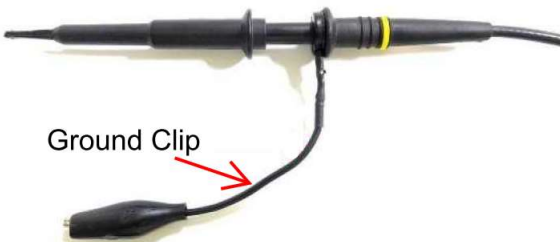

Another method is shown in below, in case of coaxial-cable/BNC is not available. The noise pickup is eliminated by pressing scope probe ground ring directly against the -Vout terminal while the tip contacts the +Vout terminal. This makes the shortest possible connection across the output terminals.

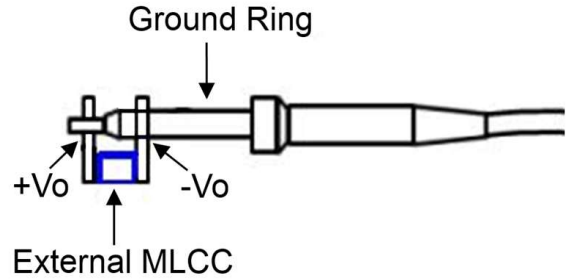

7.3 Output Capacitance

The ECLB60W series converters provide unconditional stability with or without external capacitors. For good transient response, low ESR output capacitors should be located close to the point of load (<100mm). PCB design emphasizes low resistance and inductance tracks in consideration of high current applications. Output capacitors with their associated ESR values have an impact on loop stability and bandwidth. Cincon's converters are designed to work with load capacitance to see technical specifications.



ECLB60W 49.5-60 Watt Isolated DC-DC Converters

Application Note V14

8. Thermal Design

8.1 Operating Temperature Range

The ECLB60W series converters can be operated within a wide case temperature range of -40°C to 105°C . Consideration must be given to the derating curves when ascertaining maximum power that can be drawn from the converter. The maximum power drawn from models is influenced by usual factors, such as:

- Input voltage range
- Output load current
- Forced air or natural convection
- Heat sink optional

8.2 Convection Requirements for Cooling

To predict the approximate cooling needed for the half brick module, refer to the power derating curves in **section 8.4**. These derating curves are approximations of the ambient temperatures and airflows required to keep the power module temperature below its maximum rating. Once the module is assembled in the actual system, the module's temperature should be monitored to ensure it does not exceed 105°C as measured at the center of the top of the case (thus verifying proper cooling).

8.3 Thermal Considerations

The power module operates in a variety of thermal environments; however, sufficient cooling should be provided to help ensure reliable operation of the unit. Heat is removed by conduction, convection, and radiation to the surrounding environment. The example is presented in **section 8.4**. The power output of the module should not be allowed to exceed rated power ($V_{o_set} \times I_{o_max}$).

8.4 Power Derating

The operating case temperature range of ECLB60W series is -40°C to $+105^{\circ}\text{C}$. When operating the ECLB60W series, proper derating or cooling is needed. The maximum case temperature under any operating condition should not exceed 105°C .

The following de-rating curve of ECLB60W-24S05 with heat sink and recommended PCB Layout with de-rating. (86x50x1.6mm, 2Oz.)

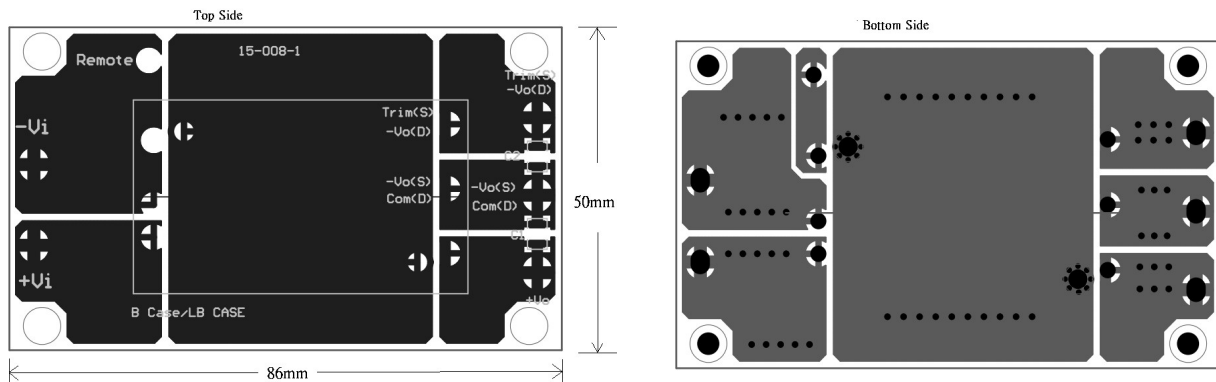



ECLB60W 49.5-60 Watt Isolated DC-DC Converters Application Note V14

Example (without heatsink):

The ECLB60W-24S05 operating at nominal line voltage, an output current of 12A, and a maximum ambient temperature of 45°C.

Solution:

Given: $V_{in}=24V_{dc}$, $V_o=5V_{dc}$, $I_o=12A$

Determine Power dissipation (P_d):

$$P_d = P_i - P_o = P_o(1-\eta)/\eta$$

$$P_d = 5 \times 12 \times (1-0.92)/0.92 = 5.22 \text{ Watts}$$

Determine airflow:

Airflow: Natural Convection

Check above Power de-rating curve:

Given: $P_d=5.22W$ and $T_a=45^\circ C$

Verifying: The maximum temperature rise $\Delta T = P_d \times R_{ca} = 5.22 \times 11.25 = 58.73^\circ C$

The maximum case temperature $T_c = T_a + \Delta T = 103.73^\circ C < 105^\circ C$

Where: The R_{ca} is thermal resistance from case to ambience.

The T_a is ambient temperature and the T_c is case temperature

Example (with heatsink M-C655):

The ECLB60W-48S05 with thermal pad SZ 29.5x49.8x0.25mm and heat sink LBT127(M-C655) operating at nominal line voltage, an output current of 15A, and a maximum ambient temperature of 60°C.

Solution:

Given: $V_{in}=48V_{dc}$, $V_o=5V_{dc}$, $I_o=12A$

Determine Power dissipation (P_d):

$$P_d = P_i - P_o = P_o(1-\eta)/\eta$$

$$P_d = 5.0 \times 12 \times (1-0.92)/0.92 = 5.22 \text{ Watts}$$

Determine airflow:

Airflow: Natural Convection

Check above Power de-rating curve:

Given: $P_d=5.22W$ and $T_a=60^\circ C$

Verifying: The maximum temperature rise $\Delta T = P_d \times R_{ca} = 5.22 \times 8.3 = 43.33^\circ C$

The maximum case temperature $T_c = T_a + \Delta T = 103.33^\circ C < 105^\circ C$

Where: The R_{ca} is thermal resistance from case to ambience.

The T_a is ambient temperature and the T_c is case temperature



ECLB60W 49.5-60 Watt Isolated DC-DC Converters

Application Note V14

8.5 LB Heat Sinks:

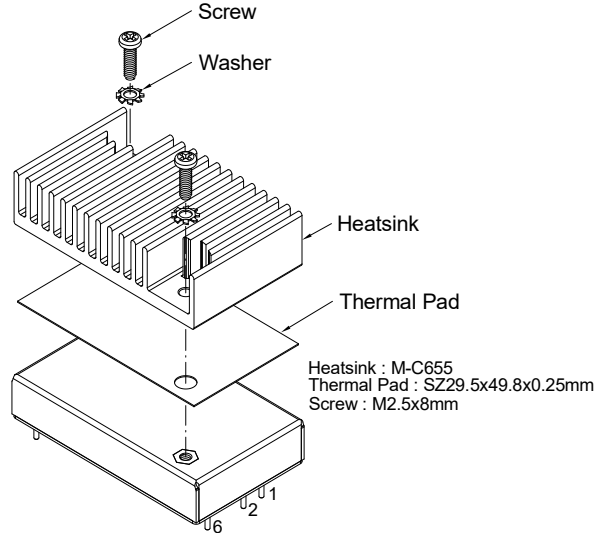
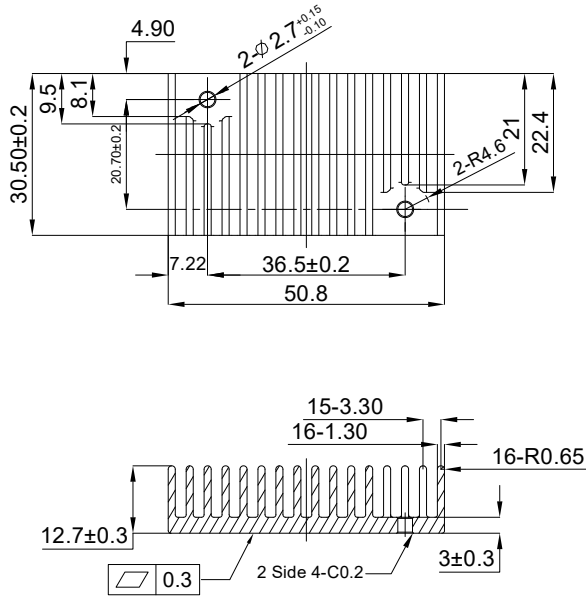

LBT127(M-C655) (G6620790202)
 Transverse Heat Sink
 All Dimensions in mm
 Thermal Pad: SZ29.5x49.8x0.25mm (G6135041753)
 Screw: M2.5x8mm (G75A3300922)
 Washer: Φ 2.6mm (G75A5750052)
 Rca: 8.99°C/W (typ.), At natural convection
 Rca: 8.3°C/W (typ.), At natural convection, mounted 85x50x1.6mm 2Oz test board.
 Recommended PCB Layout with de-rating. (86x50x1.6mm, 2Oz.)

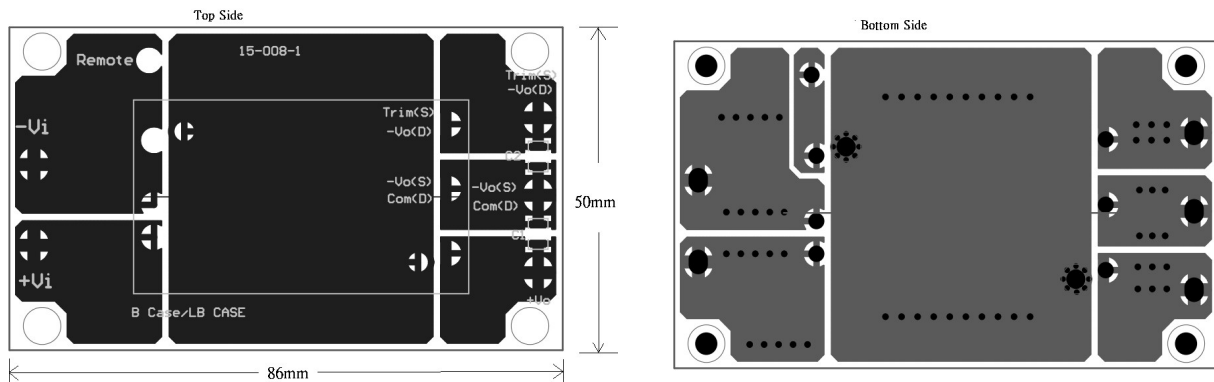



ECLB60W 49.5-60 Watt Isolated DC-DC Converters

Application Note V14

9. Safety & EMC

9.1 Input Fusing and Safety Considerations

The ECLB60W series converters have no internal fuse. In order to achieve maximum safety and system protection, always use an input line fuse. We recommended a fast acting fuse 10A for 24Vin models and 6A for 48Vin modules. It is recommended that the circuit have a transient voltage suppressor diode (TVS) across the input terminal to protect the unit against surge or spike voltage and input reverse voltage (as shown).

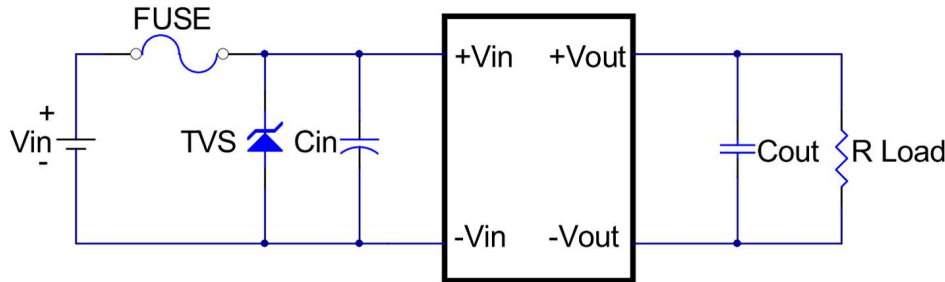

The external input capacitor (Cin) and transient voltage suppressor diode (TVS) are required if ECLB60W series has to meet EN61000-4-4, EN61000-4-5.

The Cin recommended a 220uF/63V for 24Vin models, and a 82uF/100V for 48Vin models (Nippon Chemi-Con KY series) aluminum capacitor.

The TVS recommended SMDJ40CA for 24Vin models, and SMDJ78A for 48Vin models.

9.2 EMC Considerations

EMI Test Standard: EN55022/EN55032 Class A Conducted Emission

Test Condition: Input Voltage: Nominal Input, Output Load: Full Load

(1) EMI meet EN55022/EN55032

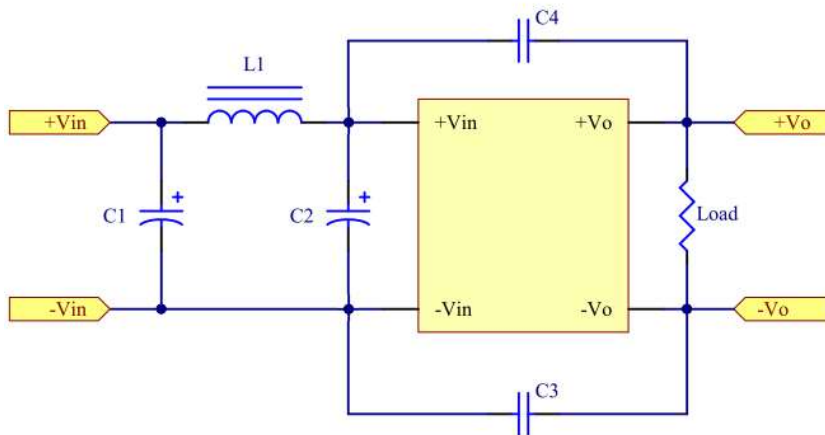

MODEL NO.	C1, C2	L1	C3~C4
ECLB60W series	220uF/63V/KY series Aluminum capacitor	3.4uH	2200pF/3KV 1808 X7R MLCC



ECLB60W 49.5-60 Watt Isolated DC-DC Converters

Application Note V14

Conducted Emission Class A:

ECLB60W-24S33
LINE

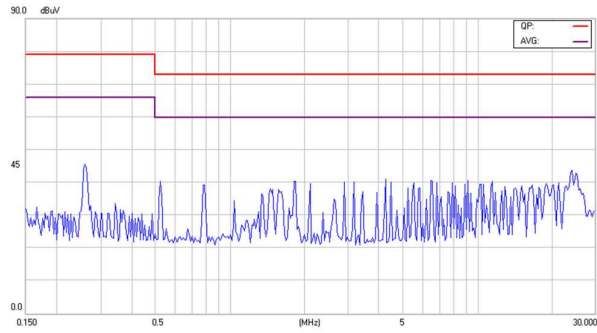

NATURE

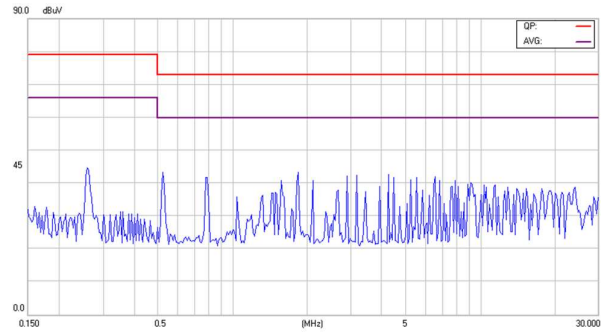

ECLB60W-24S05
LINE

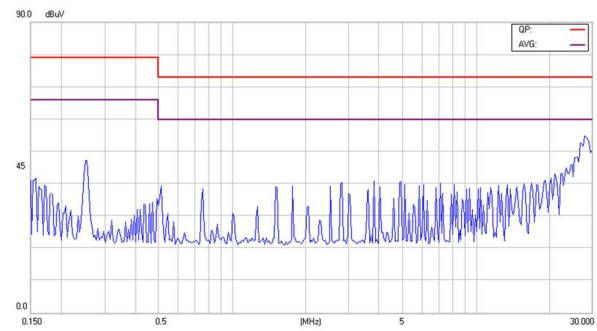

NATURE

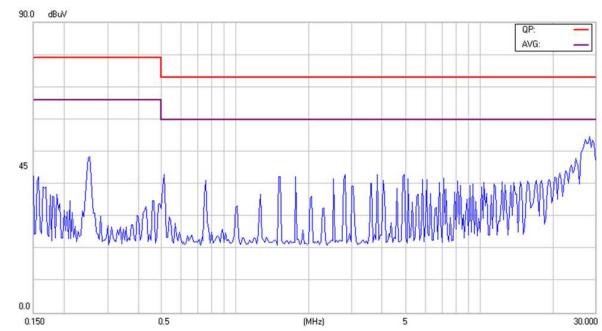

ECLB60W-24S12
LINE

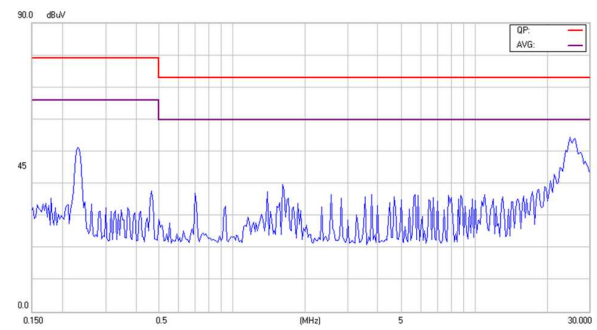

NATURE

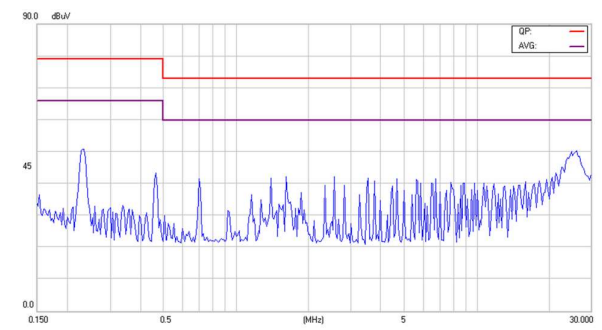



ECLB60W 49.5-60 Watt Isolated DC-DC Converters

Application Note V14

ECLB60W-24S15
LINE

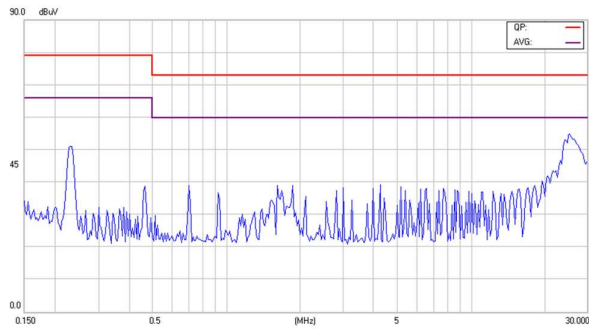

NATURE

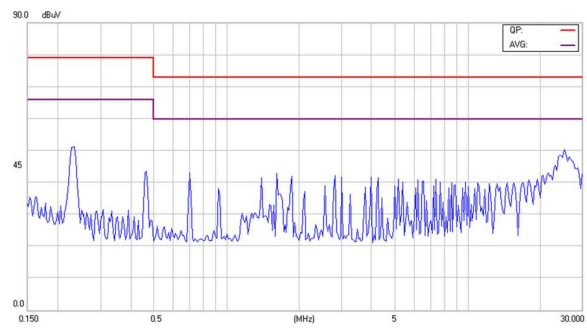

ECLB60W-24D12
LINE

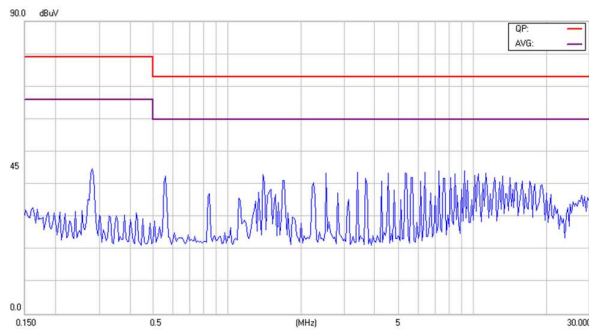

NATURE

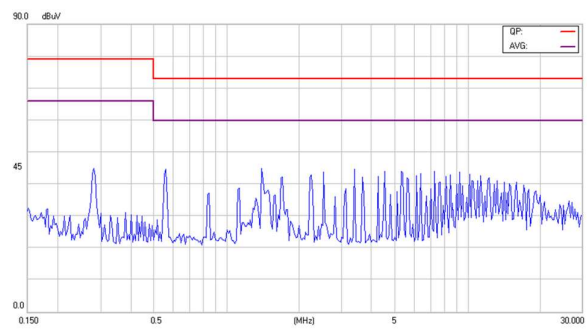

ECLB60W-24D15 LINE
LINE

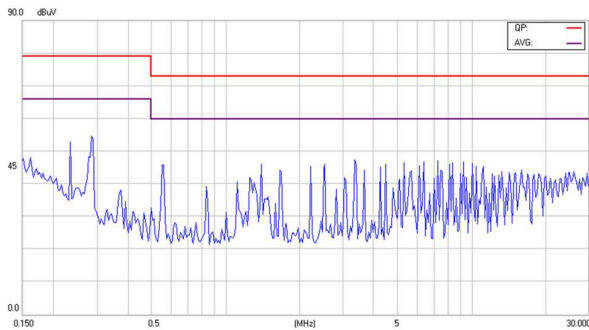

ECLB60W-24D15 NATURE
NATURE

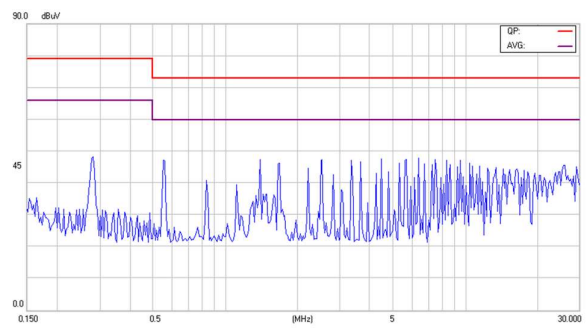



ECLB60W 49.5-60 Watt Isolated DC-DC Converters

Application Note V14

ECLB60W-48S33
LINE

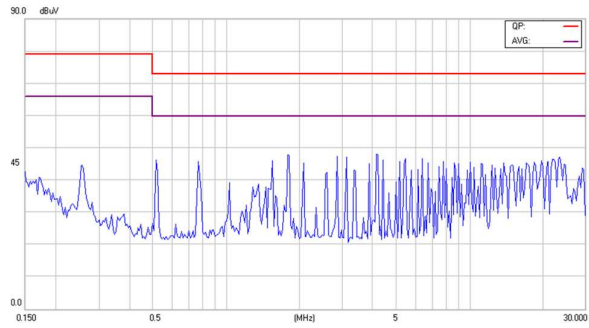

NATURE

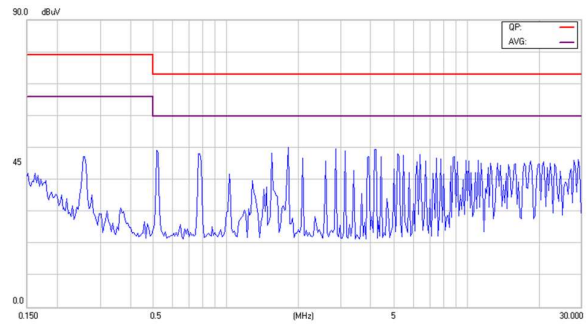

ECLB60W-48S05
LINE

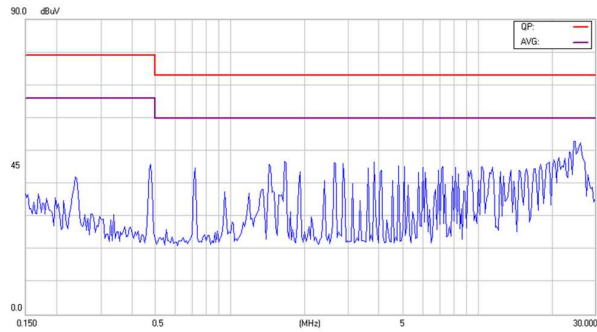

NATURE

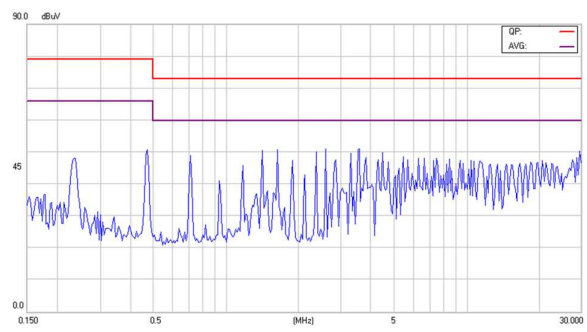

ECLB60W-48S12
LINE

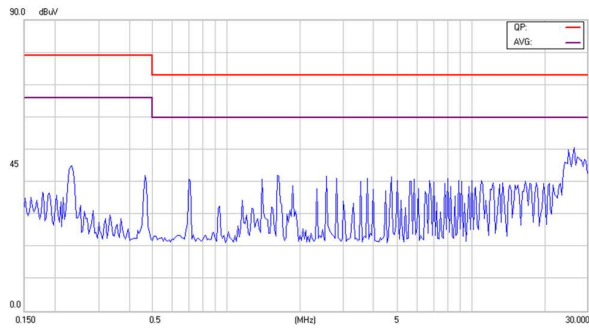

NATURE

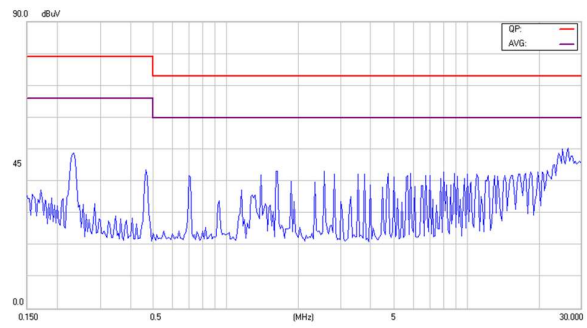



ECLB60W 49.5-60 Watt Isolated DC-DC Converters

Application Note V14

ECLB60W-48S15 LINE

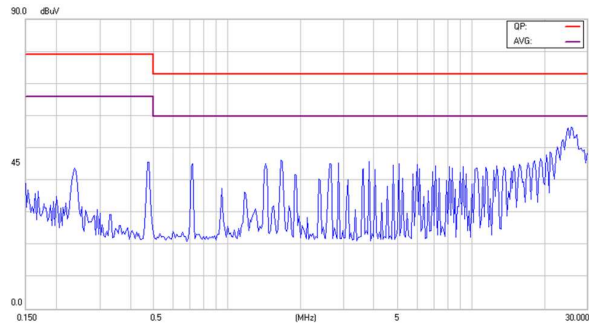

NATURE

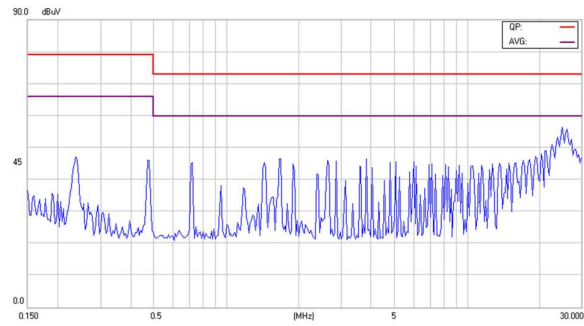

ECLB60W-48D12 LINE

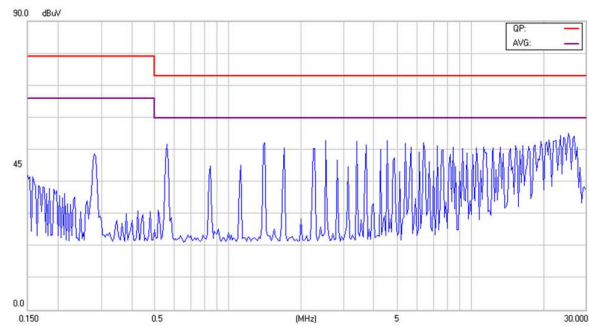

NATURE

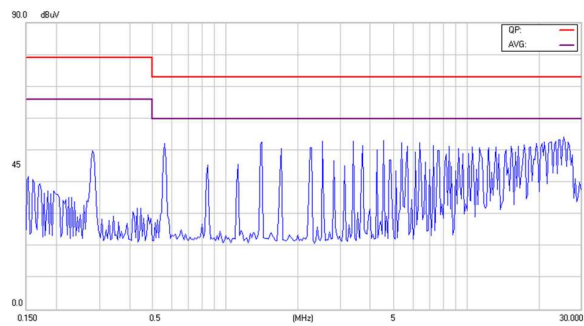

ECLB60W-48D15 LINE

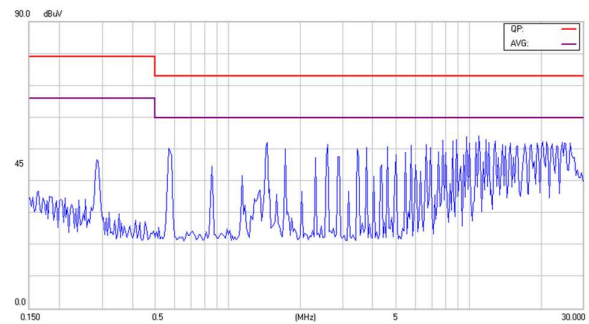

NATURE

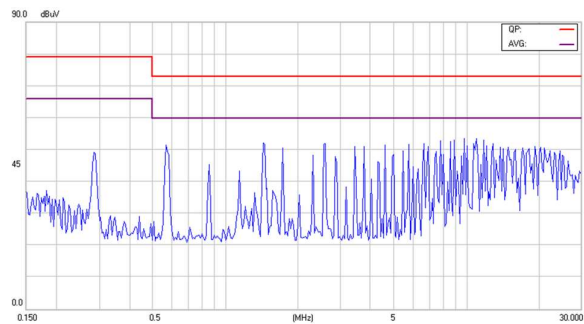

CINCON ELECTRONICS CO., LTD.

Headquarters:

14F, No.306, Sec.4, Hsin Yi Rd.
Taipei, Taiwan
Tel: 886-2-27086210
Fax: 886-2-27029852
E-mail: sales@cincon.com.tw
Web Site: <https://www.cincon.com>

Factory:

No. 8-1, Fu Kung Rd.
Fu Hsing Industrial Park
Fu Hsing Hsiang,
ChangHua Hsien, Taiwan
Tel: 886-4-7690261
Fax: 886-4-7698031

Cincon North America:

1655Mesa Verde Ave. Ste 180
Ventura, CA93003
Tel: 805-639-3350
Fax: 805-639-4101
E-mail: info@cincon.com