



EC7BW18 ECRT/EDRT Series Application Note V11

ISOLATED DC-DC CONVERTER CHASSIS MOUNT EC7BW18 ECRT/EDRT SERIES APPLICATION NOTE



Approved By:

Department	Approved By	Checked By	Written By
Research and Development Department	Enoch	Danny	Wade
		Jacky	
Quality Assurance Department	Ryan	Benny	



EC7BW18 ECRT/EDRT Series Application Note V11

Contents

1. Introduction	3
2. Pin Function Description	3
3. Terminal Block	3
4. Connection for Standard Use	4
5. Test Set-Up	4
6. Features and Functions	4
6.1 UVLO (Under Voltage Lock Out)	4
6.2 Over Current/Short Circuit Protection	5
6.3 Output Over Voltage Protection	5
6.4 Over Temperature Protection	5
6.5 Remote On/Off	5
6.6 Output Voltage Adjustment	6
7. Input / Output Considerations	6
7.1 Hold Up Time	6
7.2 Inrush Current Limiter	6
7.3 Output Ripple and Noise	6
7.4 Output Capacitance	7
8. Series and Parallel Operation	7
8.1 Series Operation	7
8.2 Parallel Operation	8
9. Thermal Design	9
9.1 Operating Temperature Range	9
9.2 Convection Requirements for Cooling	9
9.3 Thermal Considerations	9
9.4 Power Derating	9
10. Safety & EMC	10
10.1 Input Fusing and Safety Considerations	10
10.2 EMC Considerations	11



EC7BW18 ECRT/EDRT Series

Application Note V11

1. Introduction

The EC7BW18 ECRT/EDRT series of chassis mountable DC-DC converters offers 20 watts of output power @ output voltages of 5, 12, 15, ± 12 , ± 15 , ± 24 VDC. It has a wide (16:1) input voltage range of 10 to 160VDC (72VDC nominal) and 3000VAC reinforced isolation.

High efficiency up to 88%, allowing case operating temperature range of -40°C to 100°C . Very low no load power consumption (10mA), an ideal solution for energy critical systems. LED indicator for power on.

Compliant with EN55032, EN55035, EN50155, EN45545, EN50121-3-2. The standard control functions include negative remote on/off logic and +15%, -20% adjustable output voltage (single output only).

Fully protected against input UVLO (under voltage lock out), input reverse polarity, output over-current, output over-voltage and over-temperature and continuous short circuit conditions.

EC7BW18 ECRT/EDRT series is designed primarily for common railway applications of 24V, 36V, 48V, 72V, 96V, 110V nominal voltage and also suitable for distributed power architectures, telecommunications, battery operated equipment and industrial applications.

2. Pin Function Description

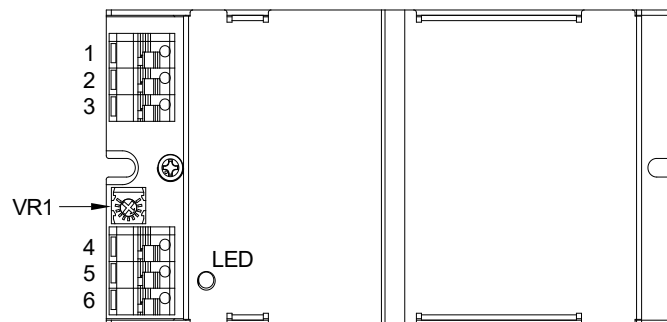

No	CN1&CN2	Description	Reference
1	+V Input	Positive Supply Input	Section 7.1/7.2
2	-V Input	Negative Supply Input	Section 7.1/7.2
3	Remote	External Remote On/Off Control	Section 6.5
Single Output			
4	Not Applicable		
5	-V Output	Negative Power Output	Section 7.3/7.4
6	+V Output	Positive Power Output	Section 7.3/7.4
VR1	Variable Resistor	Output Voltage Adjustment	Section 6.6
Dual Output			
4	-V Output	Negative Power Output	Section 7.3/7.4
5	Common	Common Power Output	Section 7.3/7.4
6	+V Output	Positive Power Output	Section 7.3/7.4
VR1	No Component		

3. Terminal Block

Input and Output Terminal Block

Terminal Type	Suitable Electric Wire (AWG)	Current Rating (max.)
DINKLE 0137-1103 or Equivalent	16-26	10A



EC7BW18 ECRT/EDRT Series Application Note V11

4. Connection for Standard Use

The connection for standard use is shown below. An external output capacitors (C1) is recommended to reduce output ripple and noise, output capacitor recommended 1 uF ceramic capacitor for all models.

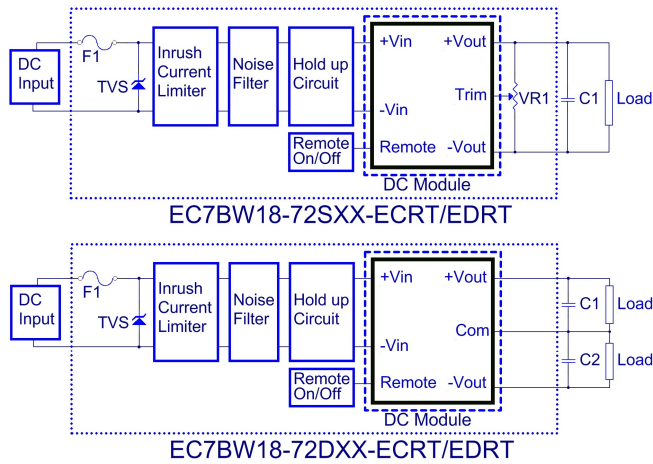

Symbol	Component	Reference
F1, TVS	Input fuse, TVS	Section 10.1
C1, C2	External capacitor on the output side	Section 7.3
VR1	Internal output voltage adjustment By variable resistor	Section 6.6
Inrush Current Limiter	Internal input Inrush current limiter	Section 7.2
Noise Filter	Internal input noise filter	Section 10.2
Hold up Circuit	Internal input hold up circuit	Section 7.1
Remote On/Off	External Remote On/Off control	Section 6.5

5. Test Set-Up

The basic test set-up to measure parameters such as efficiency and load regulation is shown below. When testing the modules under any transient conditions please ensure that the transient response of the source is sufficient to power the equipment under test. We can calculate:

- Efficiency
- Load regulation and line regulation

The value of efficiency is defined as:

$$\eta = \frac{V_o \times I_o}{V_{in} \times I_{in}} \times 100\%$$

Where:

- V_o is output voltage,
- I_o is output current,
- V_{in} is input voltage,

I_{in} is input current.

The value of load regulation is defined as:

$$Load\ reg. = \frac{V_{FL} - V_{NL}}{V_{NL}} \times 100\%$$

Where:

- V_{FL} is the output voltage at full load.
- V_{NL} is the output voltage at no load.

The value of line regulation is defined as:

$$Line\ reg. = \frac{V_{HL} - V_{LL}}{V_{LL}} \times 100\%$$

Where:

- V_{HL} is the output voltage of maximum input voltage at full load.
- V_{LL} is the output voltage of minimum input voltage at full load.

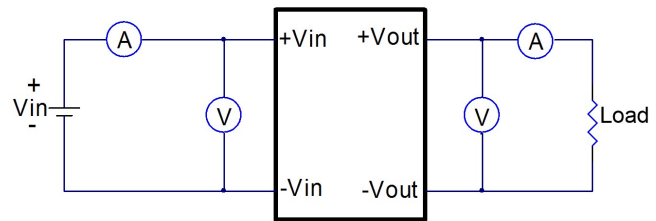

EC7BW18 ECRT/EDRT Series Test Setup

6. Features and Functions

6.1 UVLO (Under Voltage Lock Out)

Input under voltage lock out is standard on the EC7BW18 ECRT/EDRT series unit. The unit will shut down when the input voltage drops below a threshold, and the unit will operate when the input voltage goes above the upper threshold.

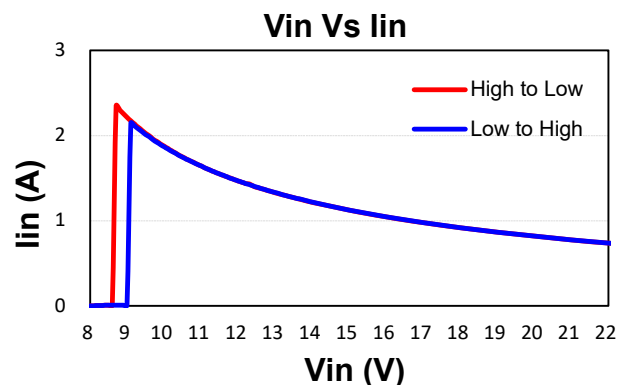



EC7BW18 ECRT/EDRT Series Application Note V11

6.2 Over Current/Short Circuit Protection

All models have internal over current and continuous short circuit protection. The unit operates normally once the fault condition is removed. At the point of current limit inception, the converter will go into hiccup mode protection.

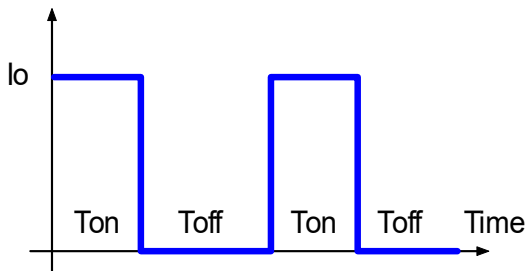
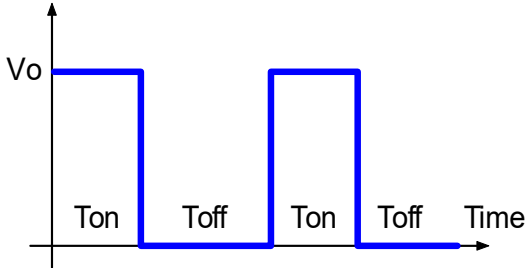

6.3 Output Over Voltage Protection

The over-voltage protection consists of a zener diode to limiting the out voltage.

6.4 Over Temperature Protection

These modules have an over temperature protection circuit to safeguard against thermal damage. Shutdown occurs with the maximum case reference temperature is exceeded. The module will restart when the case temperature falls below over temperature recovery threshold. Case plate temperature measuring point refer to the following figure.

Over Temperature Protection

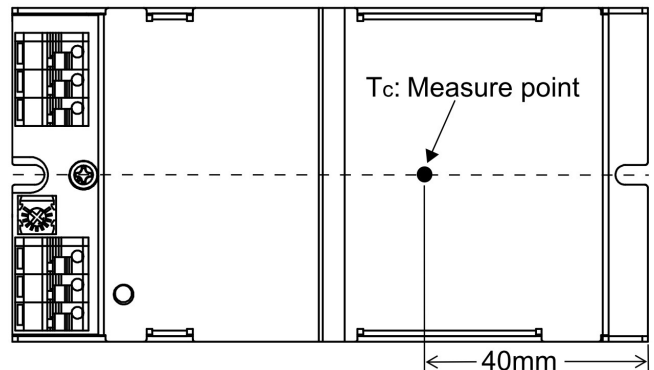
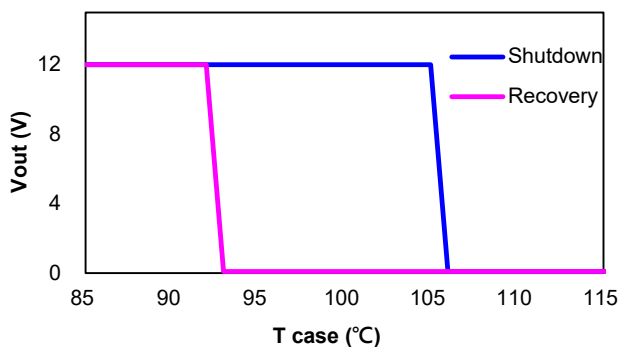

6.5 Remote On/Off

The EC7BW18 ECRT/EDRT series allows the user to switch the module on and off electronically with the remote On/Off feature. All models are available in "negative logic" versions. The converter turns off if the remote On/Off pin is high (>3.5Vdc to 12Vdc). Setting the pin low (0 to <1.2Vdc or open circuit) will turn the converter on. The signal level of the remote On/Off input is defined with respect to ground.

If not using the remote On/Off pin, leave the pin open (converter will be on).

Logic State (CN1 Pin 3)	Negative Logic
Logic Low – 0 to 1.2Vdc or Open circuit	Module on
Logic High – 3.5 to 12Vdc	Module off

The converter remote On/Off circuit built-in on input side. The ground pin of input side Remote On/Off circuit is – Vin pin. Inside connection sees below.

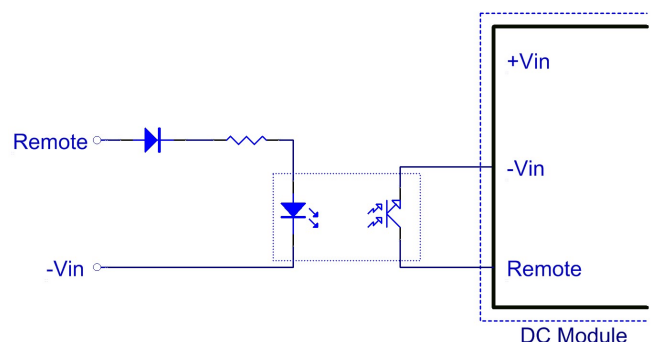



EC7BW18 ECRT/EDRT Series Application Note V11

6.6 Output Voltage Adjustment

The single output voltage model output voltage can be adjusted by internal variable resistor VR1 (adjustment range: +15% to -20% of nominal output). Turning internal variable resistor clockwise reduces the output voltage and counterclockwise increases the output voltage.

counterclockwise clockwise

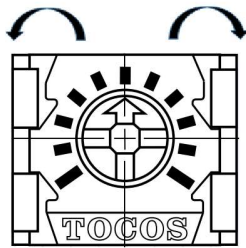

The EC7BW18-72S05-ECRT/EDRT models is adjustable within the range of -20% to +15%. For EC7BW18-72S12-ECRT/EDRT and EC7BW18-72S15-ECRT/EDRT models, see input & output trim curves for trim up and trim down ranges.

EC7BW18-72S12-ECRT/EDRT Trim Curve

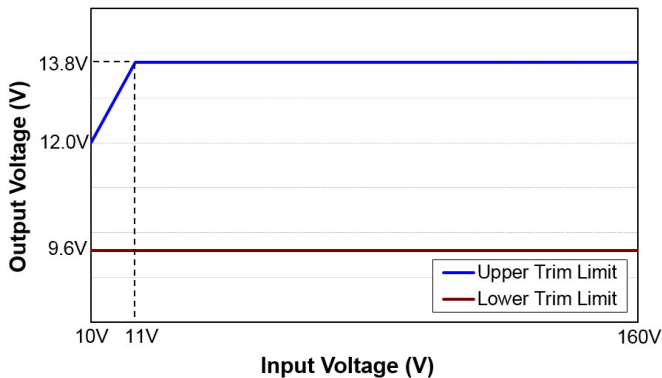

EC7BW18-72S15-ECRT/EDRT Trim Curve

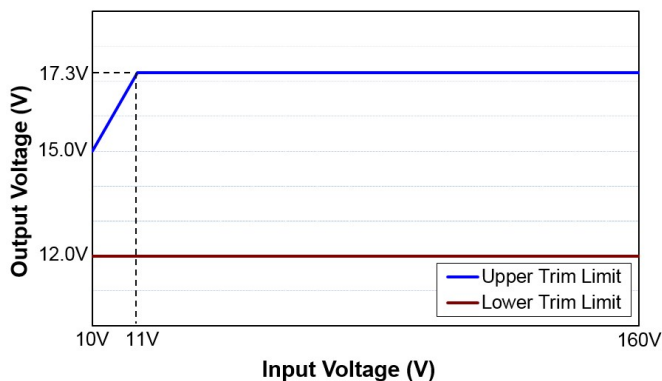

7. Input / Output Considerations

7.1 Hold Up Time

Hold up time is defined as the duration of time that DC/DC converter output will remain active following a loss of input power.

EC7BW18 ECRT/EDRT series internal with Hold up Bus Capacitor, Input voltage and output power will determine the output hold up time, refer to following figures.

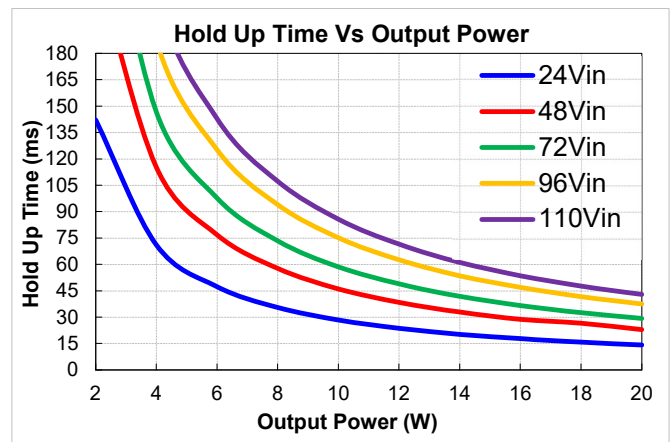

7.2 Inrush Current Limiter

These modules have inrush current limiter inside, it could reduce the inrush current from the input line to the internal capacitor when the power on.

7.3 Output Ripple and Noise

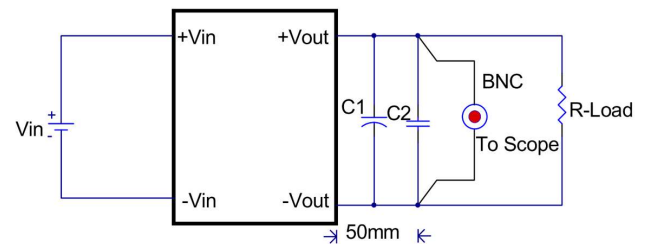

Note: C1: None, C2: 1uF ceramic capacitor.
EC7BW18-72SXX-ECRT/EDRT



EC7BW18 ECRT/EDRT Series Application Note V11

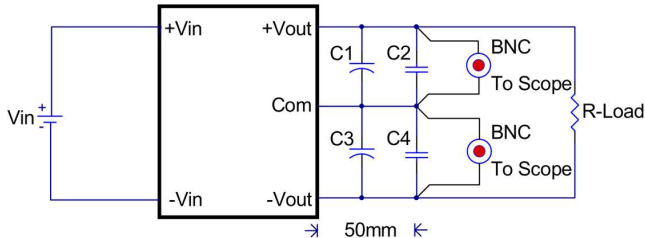

Note: C1 & C3: None, C2 & C4: 1uF ceramic capacitor.
EC7BW18-72DXX-ECRT/EDRT

Output ripple and noise measured with 1uF ceramic capacitors across output. A 20 MHz bandwidth oscilloscope is normally used for the measurement.

The conventional ground clip on an oscilloscope probe should never be used in this kind of measurement. This clip, when placed in a field of radiated high frequency energy, acts as an antenna or inductive pickup loop, creating an extraneous voltage that is not part of the output noise of the converter.



Another method is shown in below, in case of coaxial-cable/BNC is not available. The noise pickup is eliminated by pressing scope probe ground ring directly against the -Vout terminal while the tip contacts the +Vout terminal. This makes the shortest possible connection across the output terminals.

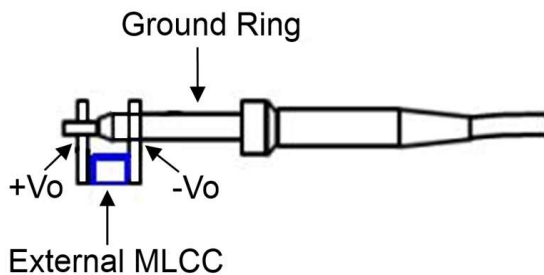

7.4 Output Capacitance

The EC7BW18 ECRT/EDRT series converters provide unconditional stability with or without external capacitors. For good transient response, low ESR output capacitors should be located close to the point of load (<100mm). PCB design emphasizes low resistance and inductance tracks in consideration of high current applications. Output capacitors with their associated ESR values have

an impact on loop stability and bandwidth. Cincon's converters are designed to work with load capacitance to see technical specifications.

8. Series and Parallel Operation

8.1 Series Operation

Series operation is possible by connecting the outputs two or more units. Connection is shown in below. The output current in series connection should be lower than the lowest rate current in each power module.

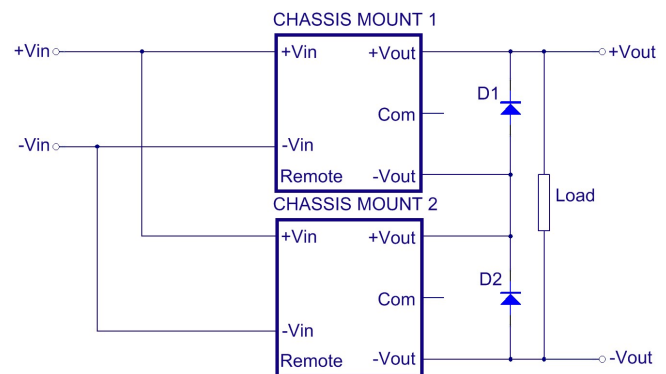
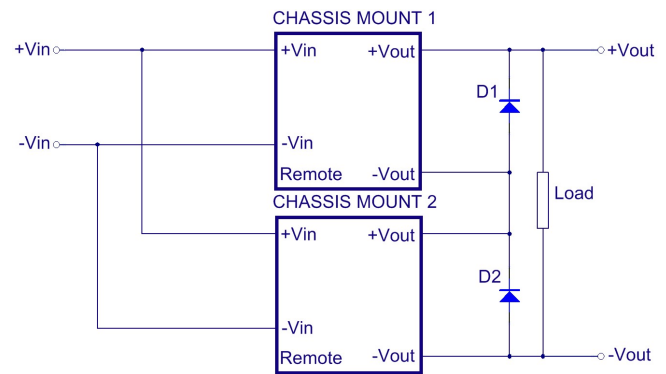

Simple Series Operation Connect Circuit



EC7BW18 ECRT/EDRT Series Application Note V11

Note:

Recommend Schottky diode (D1, D2) be connected across the output of each series connected converter, so that if one converter shuts down for any reason, then the output stage won't be thermally overstressed. Without this external diode, the output stage of the shut-down converter could carry the load current provided by the other series converters, with its MOSFETs conducting through the body diodes. The MOSFETs could then be overstressed and fail. The external diode should be capable of handling the full load current for as long as the application is expected to run with any unit shut down.

Series for \pm output operation is possible by connecting the outputs two units, as shown in the schematic below.

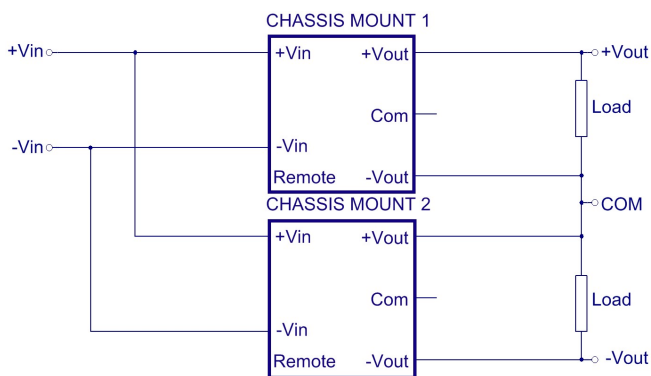
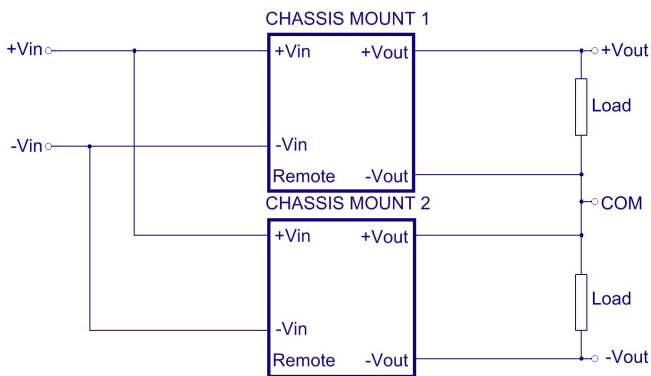

Simple \pm Output Operation Connect Circuit

8.2 Parallel Operation

The EC7BW18 ECRT/EDRT series parallel operation is not possible.



EC7BW18 ECRT/EDRT Series Application Note V11

9. Thermal Design

9.1 Operating Temperature Range

The EC7BW18 ECRT/EDRT series converters can be operated within a wide case temperature range of -40°C to 100°C. Consideration must be given to the derating curves when ascertaining maximum power that can be drawn from the converter. The maximum power drawn from chassis mount models is influenced by usual factors, such as:

- Input voltage range
- Output load current
- Forced air or natural convection

9.2 Convection Requirements for Cooling

To predict the approximate cooling needed for the chassis mount module, refer to the power derating curves in **section 9.4**. These derating curves are approximations of the ambient temperatures and airflows required to keep the power module temperature below its maximum rating. Once the module is assembled in the actual system, the module's case plate temperature should be monitored to ensure it does not exceed 100°C (case plate temperature measuring point refer to the **section 6.4**).

9.3 Thermal Considerations

The power module operates in a variety of thermal environments; however, sufficient cooling should be provided to help ensure reliable operation of the unit. Heat is removed by conduction, convection, and radiation to the surrounding environment. The example is presented in **section 9.4**. The power output of the module should not be allowed to exceed rated power ($V_{o_set} \times I_{o_max}$).

9.4 Power Derating

The operating case temperature range of EC7BW18 ECRT/EDRT series is -40°C to +100°C. When operating the EC7BW18 ECRT/EDRT series, proper derating or cooling is needed. The maximum case temperature under any operating condition should not exceed 100°C (case temperature measure point refer to the section 6.4).

The following curve is the de-rating curve of EC7BW18 ECRT/EDRT series.

**EC7BW18 ECRT/EDRT Derating Curve
for Natural Convection (Vin=72V)**

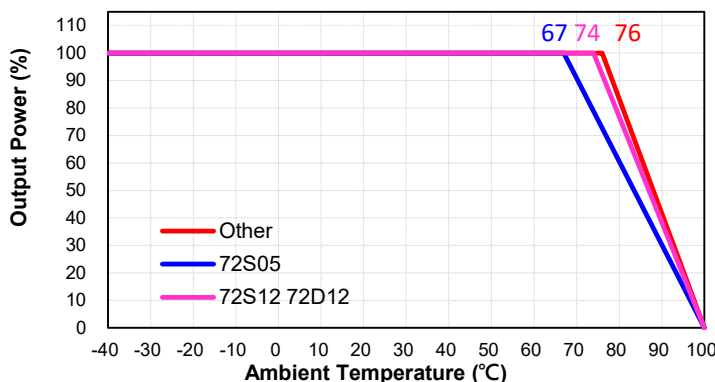

AIR FLOW RATE	TYPICAL R_{ca}
Natural Convection 20ft./min. (0.1m/s)	8.7 °C/W



EC7BW18 ECRT/EDRT Series Application Note V11

Example:

What is the maximum ambient temperature for a EC7BW18-72S05-ECRT operating at nominal line voltage, an output current of 4A, and natural convection?

Solution:

Given: $V_{in} = 72V_{dc}$, $V_o = 5V_{dc}$, $I_o = 4A$

Determine Power dissipation (P_d): $P_d = P_i - P_o = P_o(1-\eta)/\eta$, $P_d = 5 \times 4 \times (1-0.84)/0.84 = 3.81\text{Watts}$

Determine Maximum temperature rise: $\Delta T = P_d \times R_{ca} = 3.81 \times 8.7 = 33.1^\circ\text{C}$

Determine Maximum Ambient temperature: $T_a = T_{c\max} - \Delta T = 100^\circ\text{C} - 33.1^\circ\text{C} = 66.9^\circ\text{C}$

Where:

The R_{ca} is thermal resistance from case to ambient environment.

T_a is ambient temperature and $T_{c\max}$ is maximum operating case temperature.

10. Safety & EMC

10.1 Input Fusing and Safety Considerations

The EC7BW18 ECRT/EDRT series converters have internal fuse. Achieve maximum safety and system protection, Input line fuse specification is 3.15A time delay. Have a transient voltage suppressor diode (TVS) across the input terminal to protect the unit against surge or spike voltage and input reverse voltage (as shown).

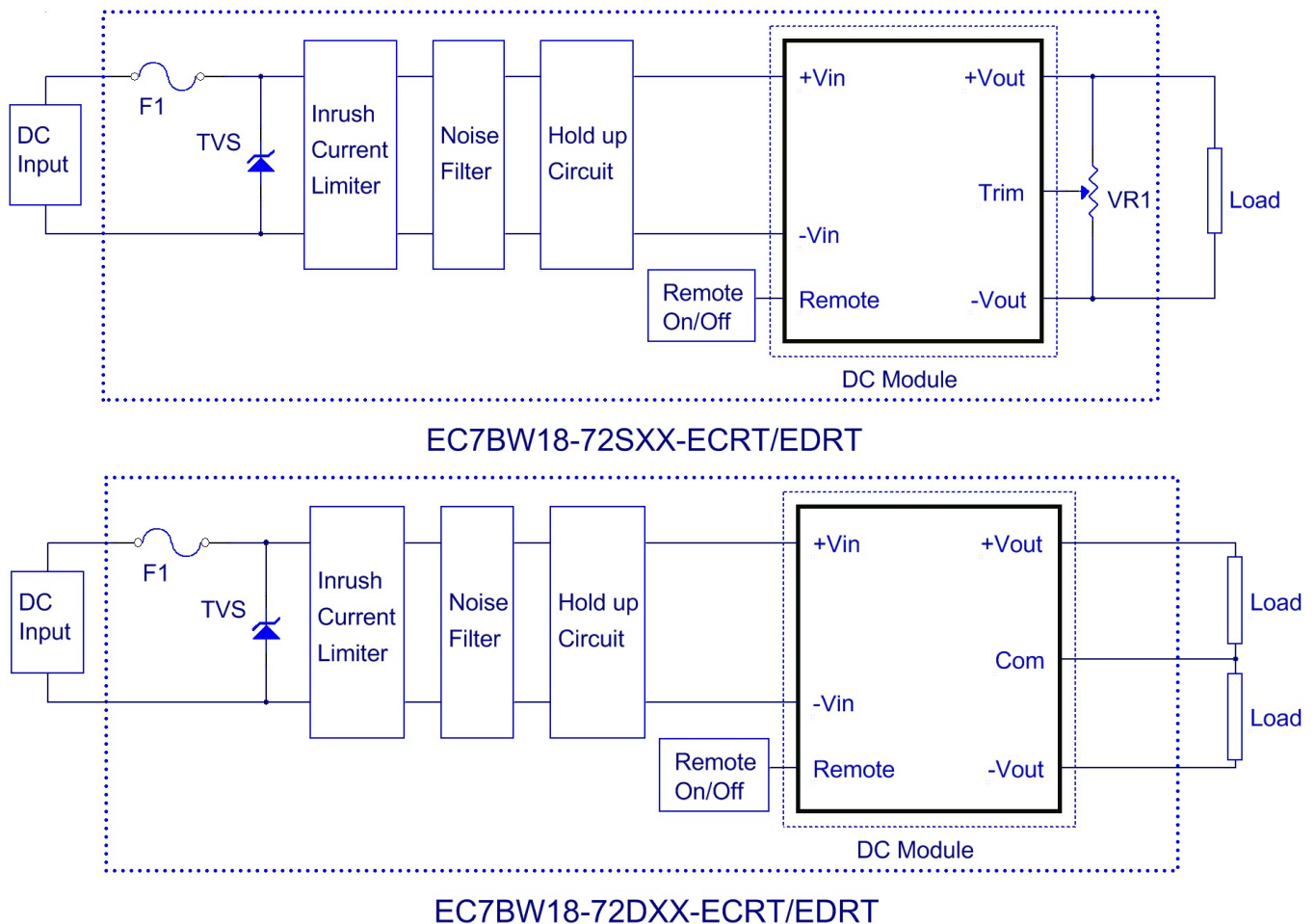



EC7BW18 ECRT/EDRT Series Application Note V11

10.2 EMC Considerations

EMI Test standard: EN55032 Class A, EN50121-3-2

Test Condition: Input Voltage: 110Vdc, Output Load: Full Load

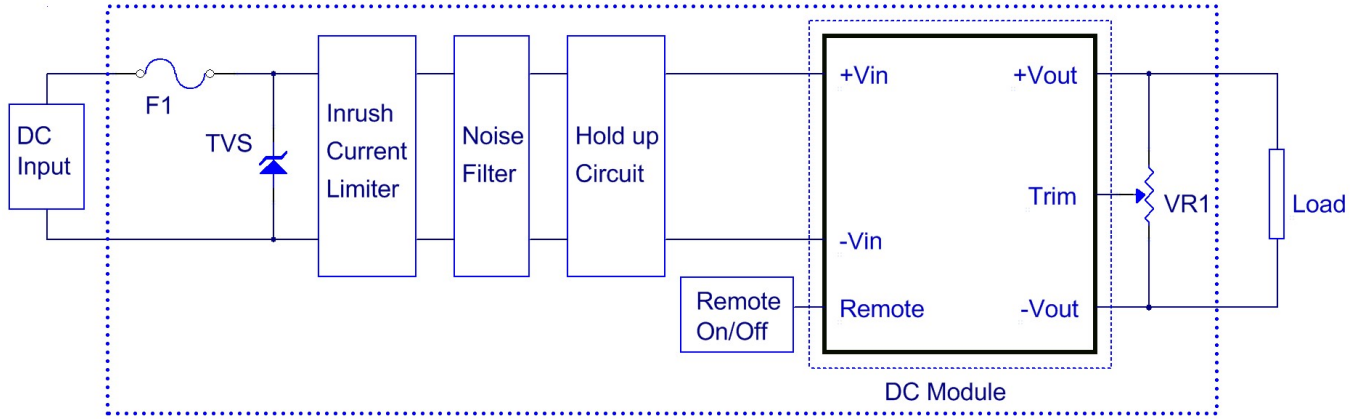

EC7BW18-72SXX-ECRT

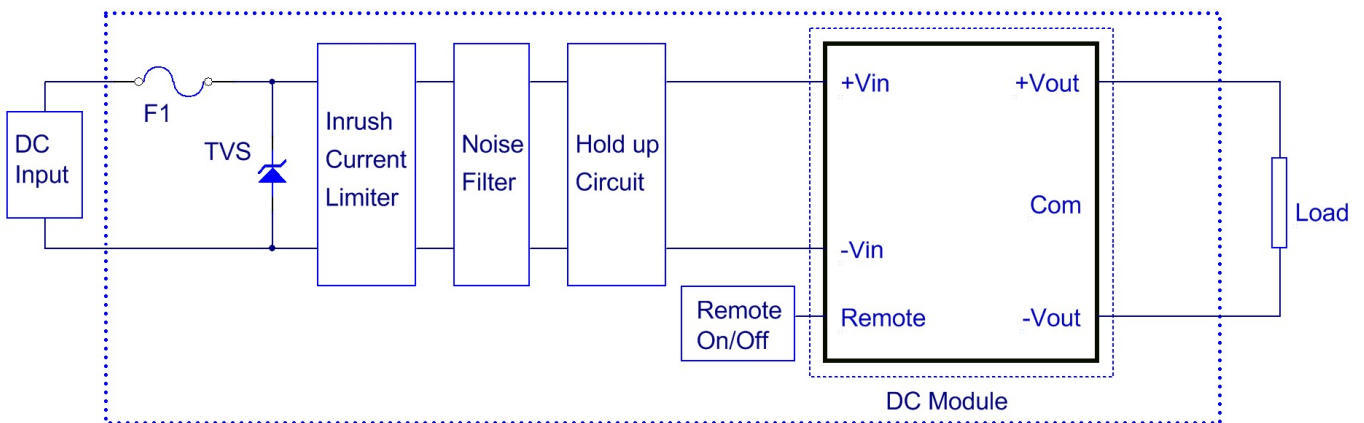

EC7BW18-72DXX-ECRT

Connection circuit for EN55032 & EN50121-3-2 EMI testing



EC7BW18 ECRT/EDRT Series Application Note V11

Input Conducted Emission (EN55032):

EC7BW18-72S05-ECRT

Line

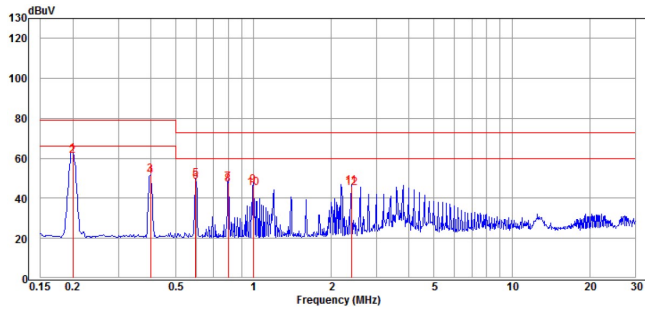

Neutral

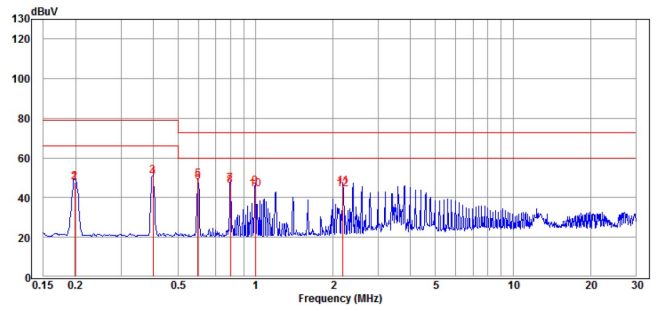

EC7BW18-72S12-ECRT

Line

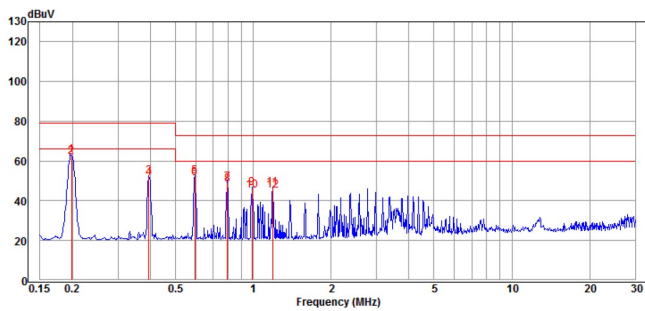

Neutral

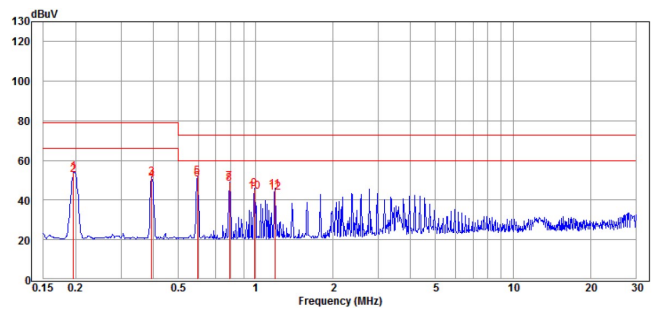

EC7BW18-72S15-ECRT

Line

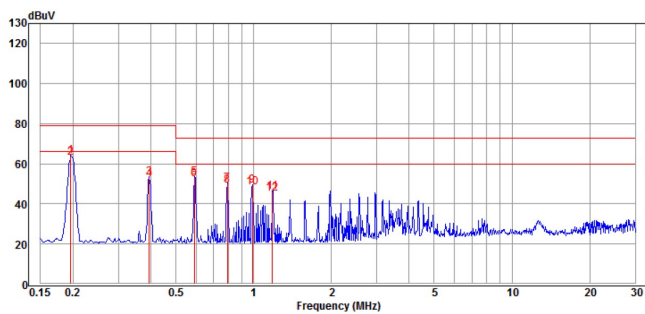

Neutral

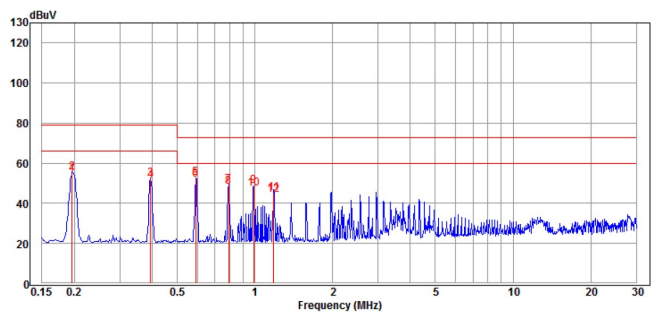

EC7BW18-72D12-ECRT

Line

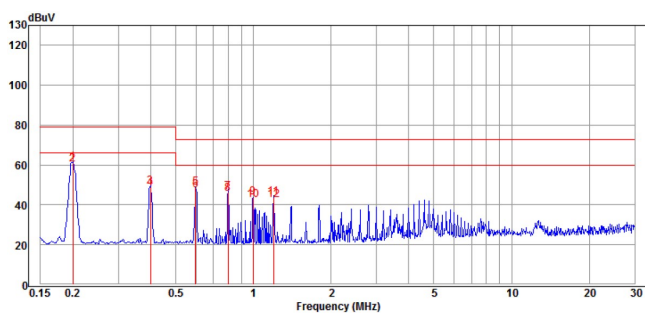

Neutral

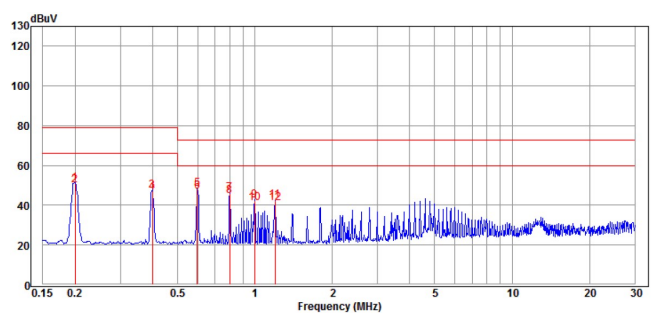



EC7BW18 ECRT/EDRT Series Application Note V11

EC7BW18-72D15-ECRT

Line

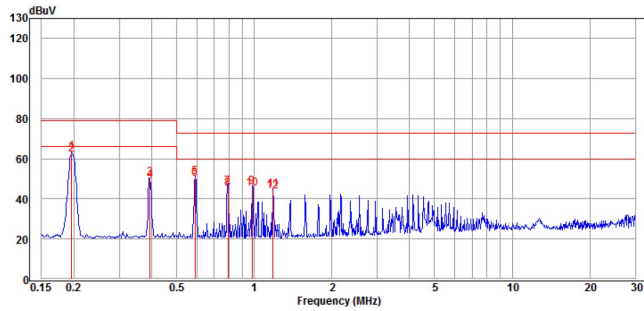

Neutral

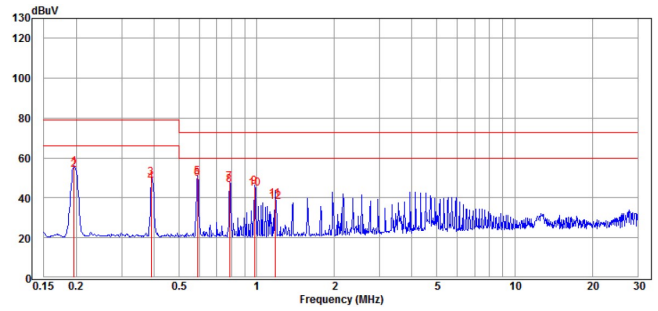

EC7BW18-72D24-ECRT

Line

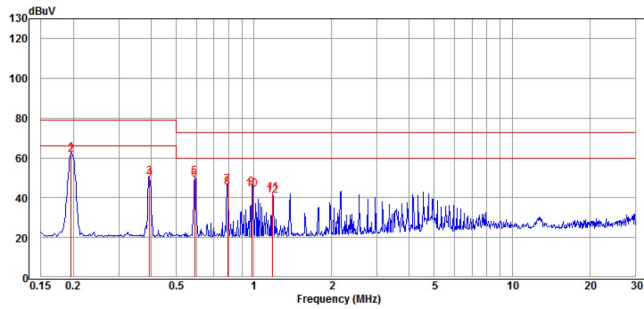

Neutral

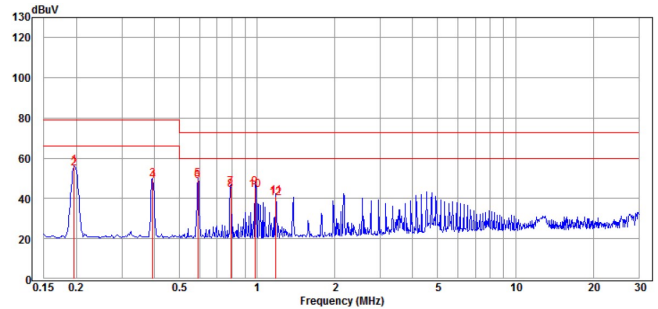

Input Conducted Emission (EN50121-3-2):

EC7BW18-72S05-ECRT

Line

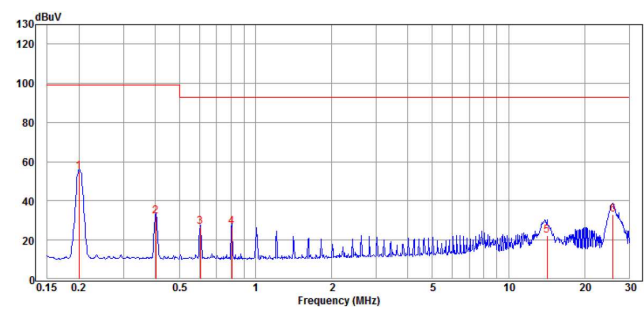

Neutral

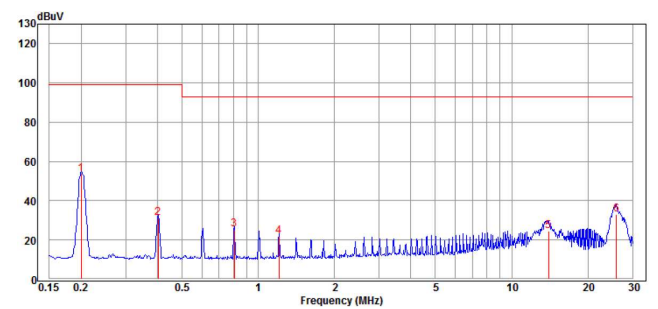

EC7BW18-72S12-ECRT

Line

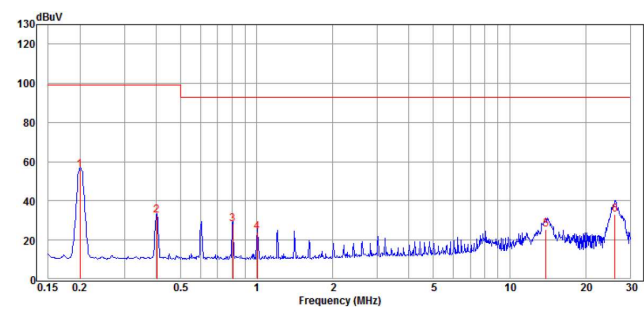

Neutral

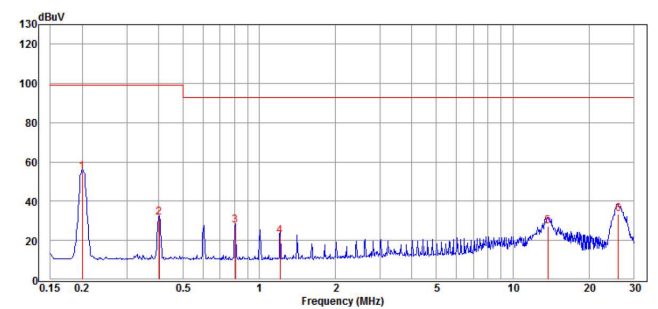



EC7BW18 ECRT/EDRT Series Application Note V11

EC7BW18-72S15-ECRT

Line

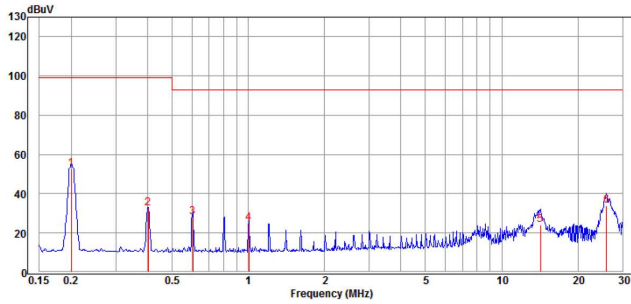

Neutral

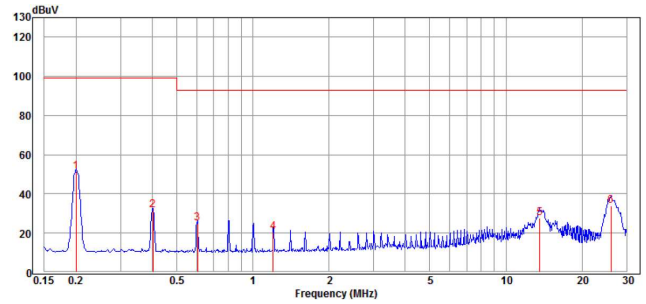

EC7BW18-72D12-ECRT

Line

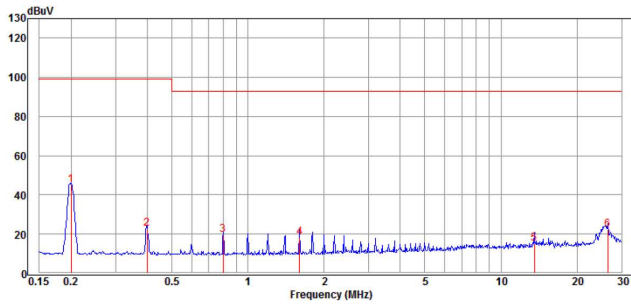

Neutral

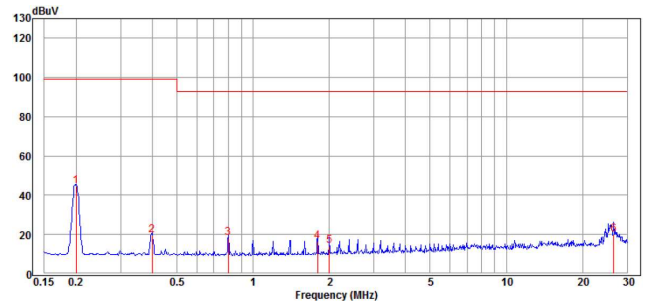

EC7BW18-72D15-ECRT

Line

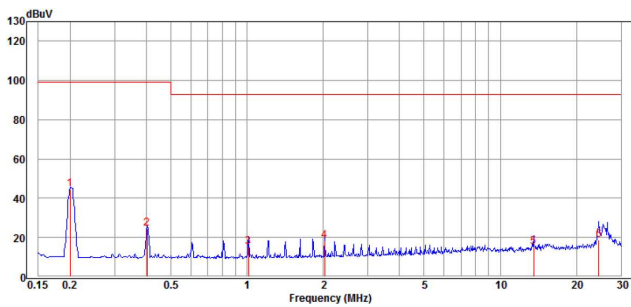

Neutral

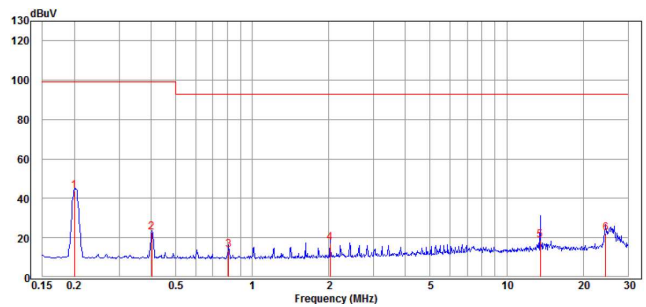

EC7BW18-72D24-ECRT

Line

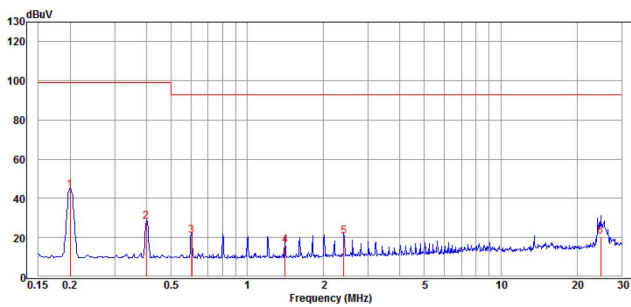

Neutral

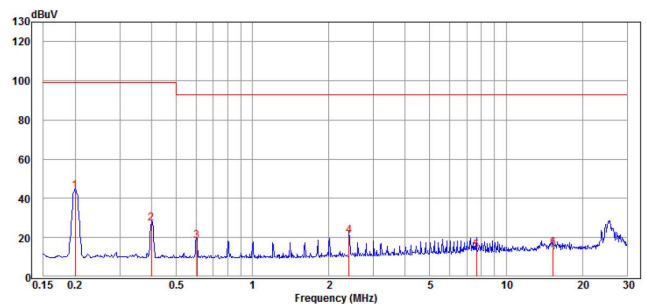



EC7BW18 ECRT/EDRT Series Application Note V11

Output Conducted Emission:

EC7BW18-72S05-ECRT

Positive

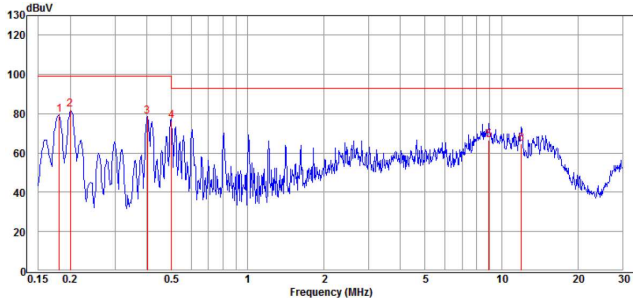

Negative

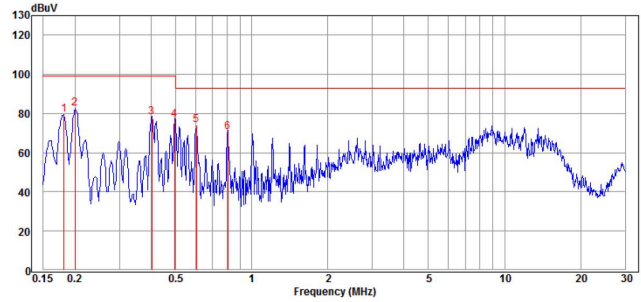

EC7BW18-72S12-ECRT

Positive

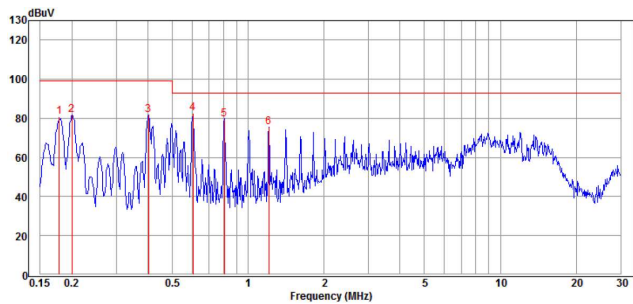

Negative

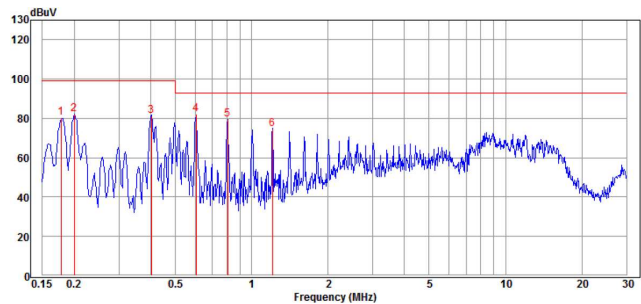

EC7BW18-72S15-ECRT

Positive

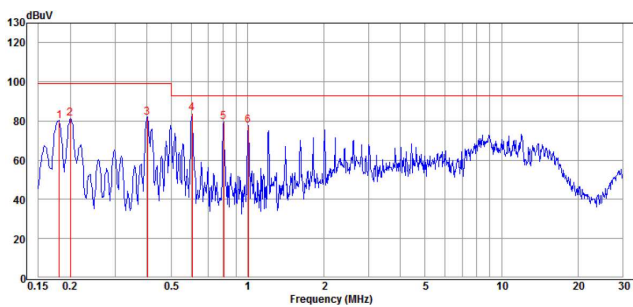

Negative

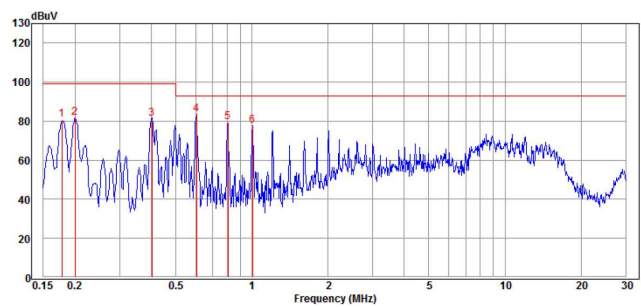

EC7BW18-72D12-ECRT

Positive

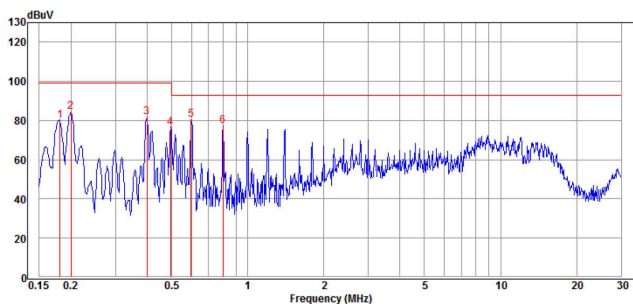

Negative

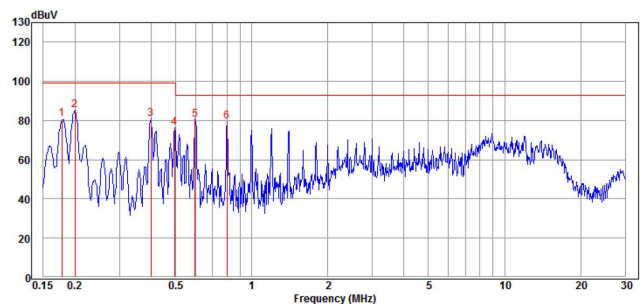



EC7BW18 ECRT/EDRT Series Application Note V11

EC7BW18-72D15-ECRT

Positive

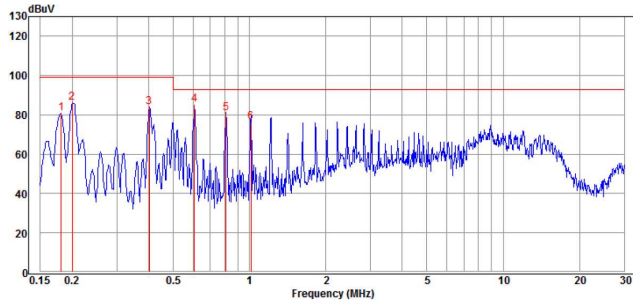

Negative

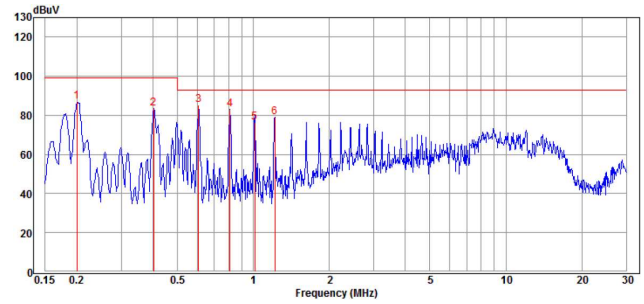

EC7BW18-72D24-ECRT

Positive

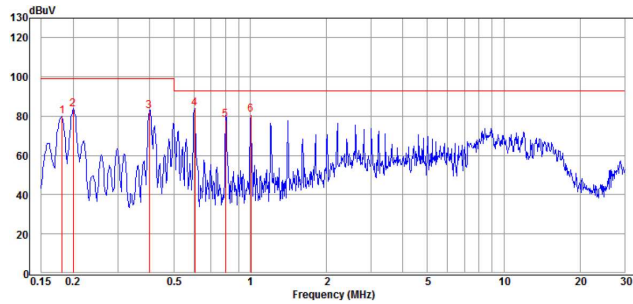

Negative

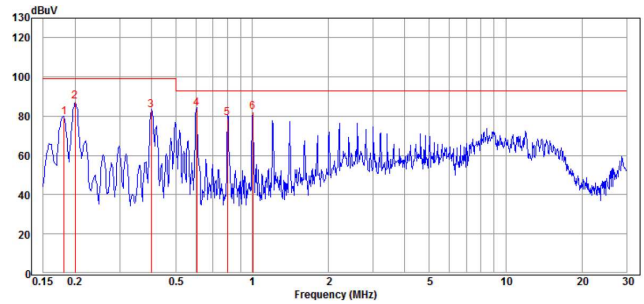

Radiated Emission (EN55032):

EC7BW18-72S05-ECRT

Vertical

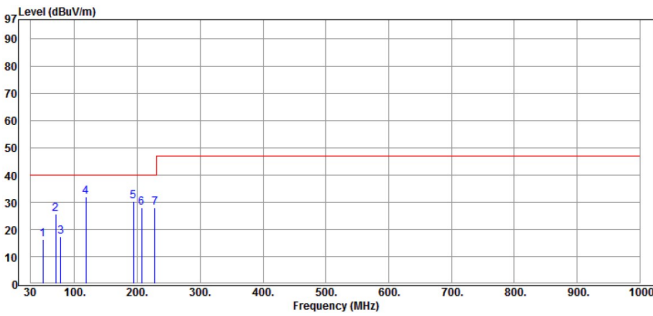

Horizontal

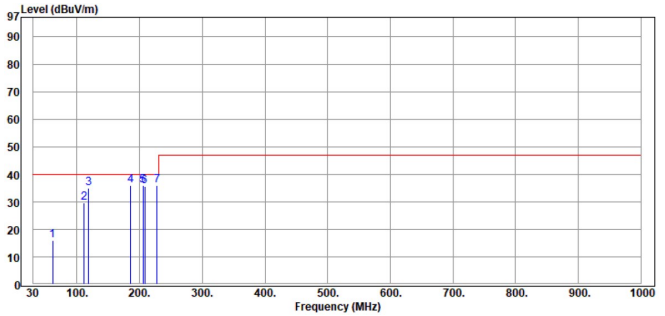

EC7BW18-72S12-ECRT

Vertical

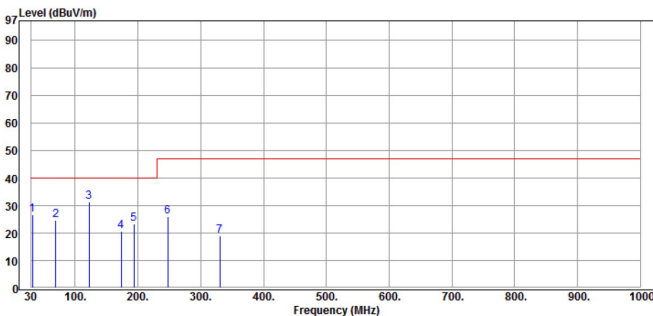

Horizontal

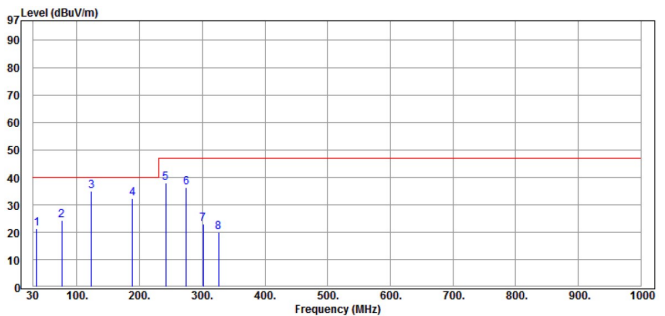



EC7BW18 ECRT/EDRT Series

Application Note V11

EC7BW18-72S15-ECRT

Vertical

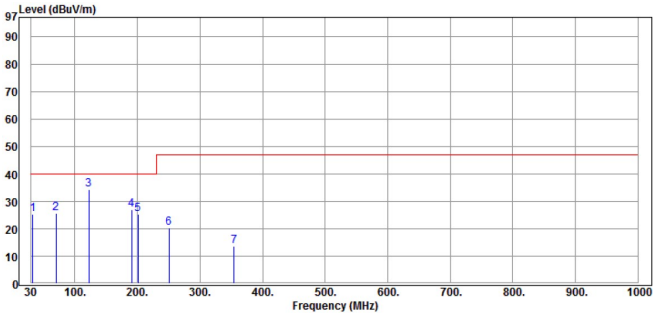

Horizontal

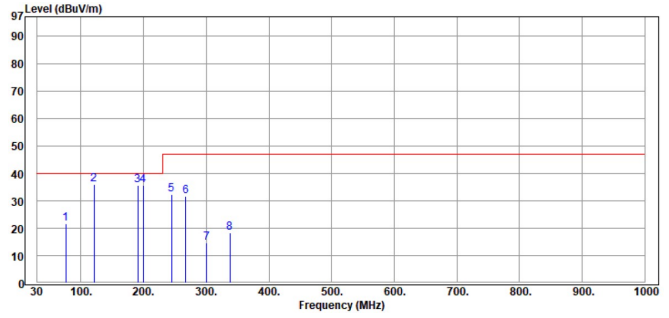

EC7BW18-72D12-ECRT

Vertical

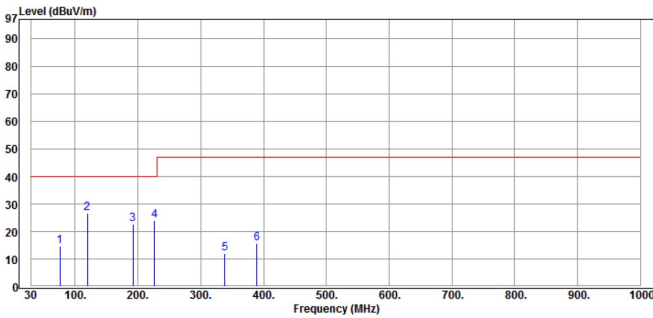

Horizontal

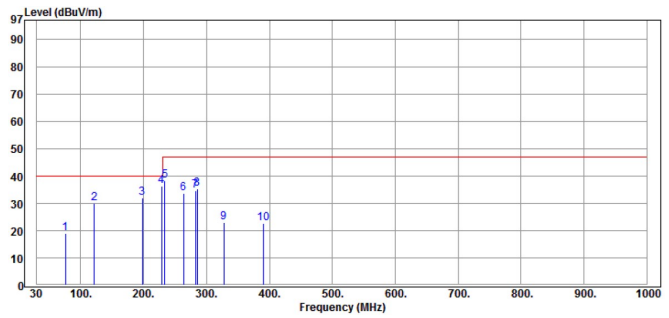

EC7BW18-72D15-ECRT

Vertical

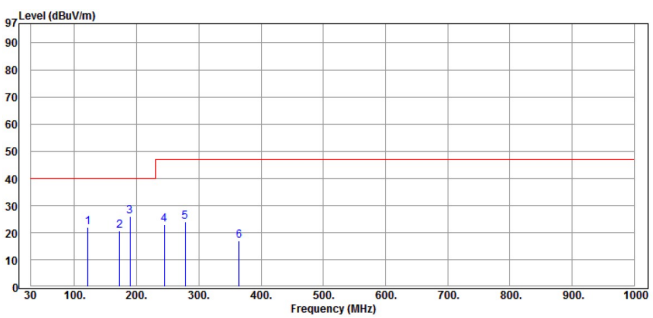

Horizontal

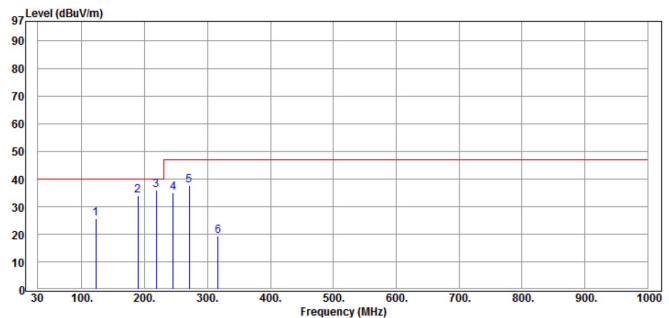

EC7BW18-72D24-ECRT

Vertical

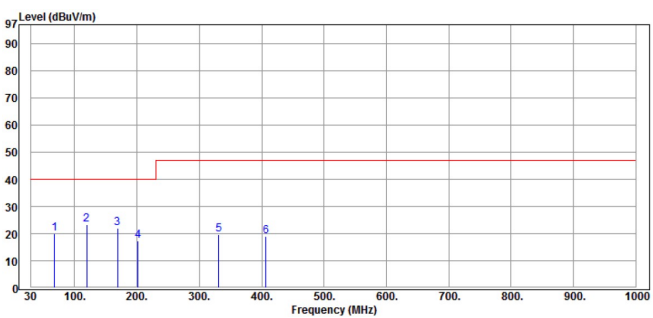

Horizontal

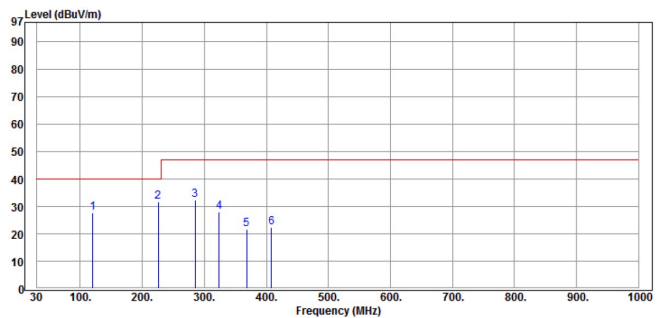



EC7BW18 ECRT/EDRT Series Application Note V11

Radiated Emission (EN50121-3-2):

EC7BW18-72S05-ECRT

Vertical

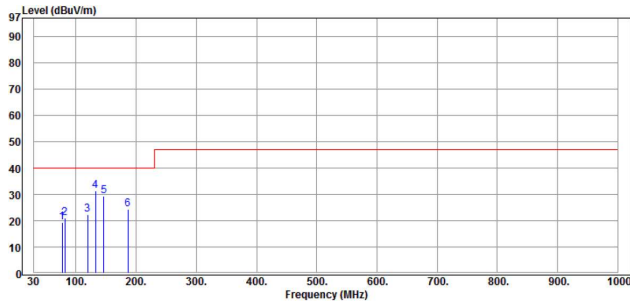

Horizontal

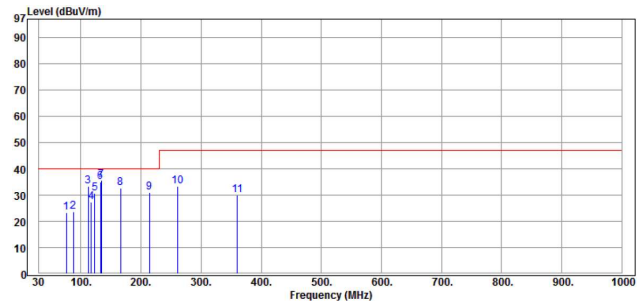

EC7BW18-72S12-ECRT

Vertical

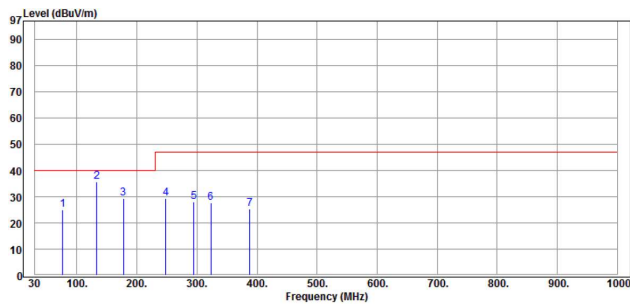

Horizontal

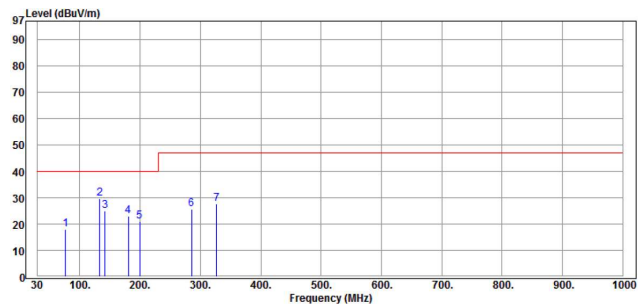

EC7BW18-72S15-ECRT

Vertical

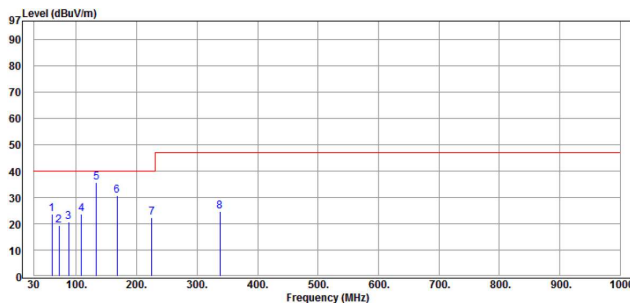

Horizontal

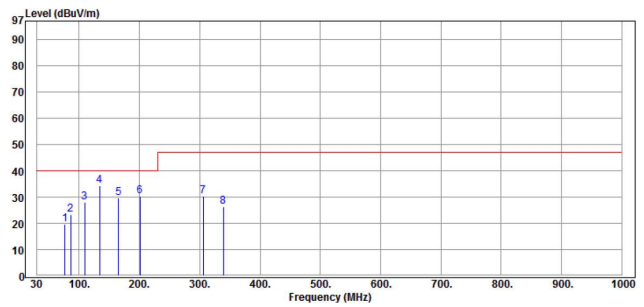

EC7BW18-72D12-ECRT

Vertical

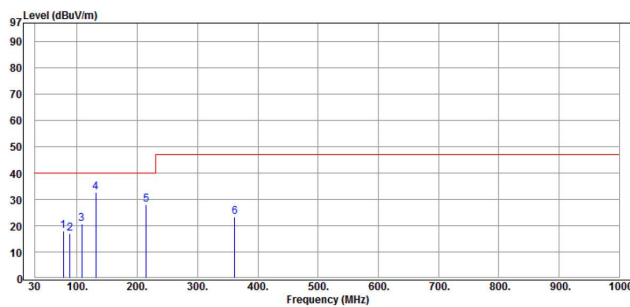

Horizontal

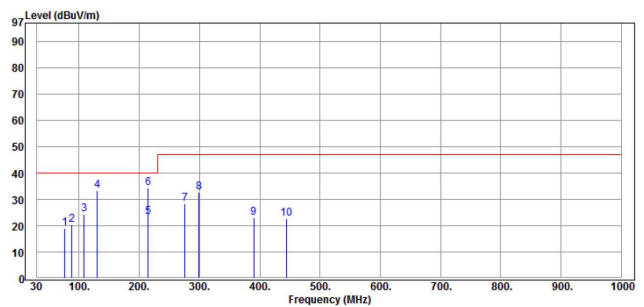



EC7BW18 ECRT/EDRT Series Application Note V11

EC7BW18-72D15-ECRT

Vertical

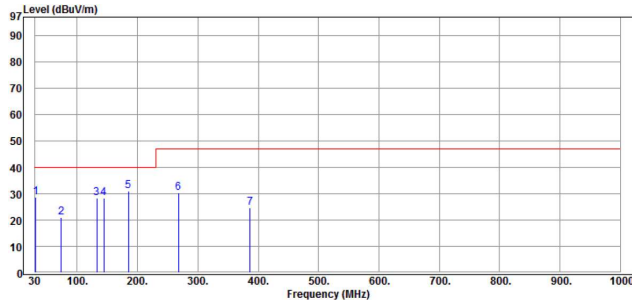

Horizontal

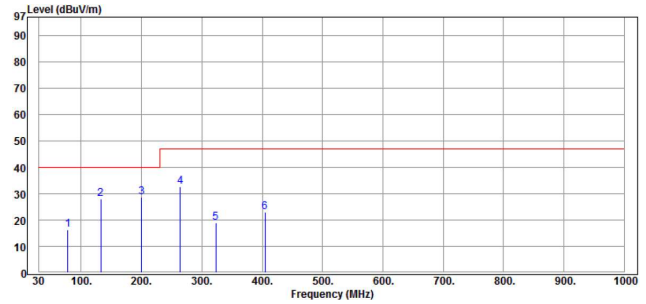

EC7BW18-72D24-ECRT

Vertical

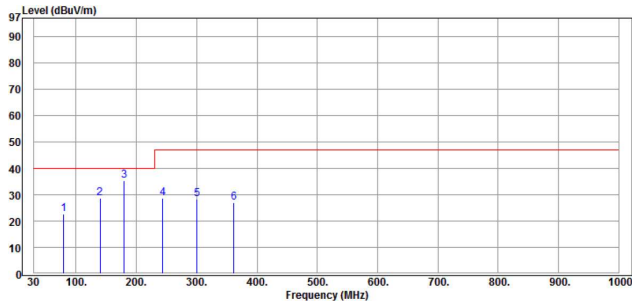

Horizontal

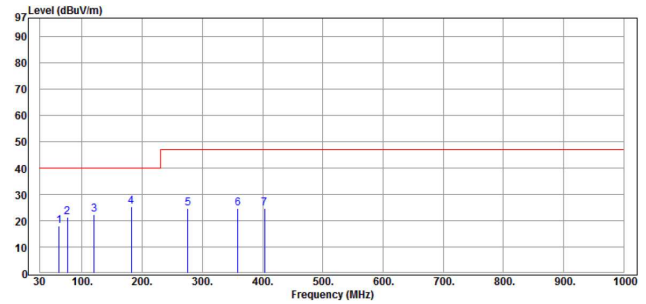

CINCON ELECTRONICS CO., LTD.

Headquarters:

14F, No.306, Sec.4, Hsin Yi Rd.
Taipei, Taiwan
Tel: 886-2-27086210
Fax: 886-2-27029852
E-mail: support@cincon.com.tw
Web Site: <http://www.cincon.com>

Factory:

No. 8-1, Fu Kung Rd.
Fu Hsing Industrial Park
Fu Hsing Hsiang,
ChangHua Hsien, Taiwan
Tel: 886-4-7690261
Fax: 886-4-7698031

Cincon North America:

1655Mesa Verde Ave. Ste 180
Ventura, CA93003
Tel: 805-639-3350
Fax: 805-639-4101
E-mail: info@cincon.com