



# EC7A 10W Isolated DC-DC Converters

Application Note V10 April 2010

## ISOLATED DC-DC Converter EC7A SERIES APPLICATION NOTE



Approved By:

Department	Approved By	Checked By	Written By
Research and Development Department	Enoch	Johnny	Joyce
		Jacky Danny	
Quality Assurance Department	Jack	Benny	



# EC7A 10W Isolated DC-DC Converters

Application Note V10 April 2010

---

## Content

<b>1. INTRODUCTION</b>	<b>3</b>
<b>2. DC-DC CONVERTER FEATURES</b>	<b>3</b>
<b>3. ELECTRICAL BLOCK DIAGRAM</b>	<b>3</b>
<b>4. TECHNICAL SPECIFICATIONS</b>	<b>4</b>
<b>5. MAIN FEATURES AND FUNCTIONS</b>	<b>7</b>
5.1 Operating Temperature Range	7
5.2 UVLO (Under Voltage Lock Out)	7
5.3 Over Current Protection	7
5.4 Over Voltage Protection	7
<b>6. APPLICATIONS</b>	<b>8</b>
6.1 Recommended Layout PCB Footprints and Soldering Information	8
6.2 Power De-Rating Curves for EC7A Series	9
6.3 Efficiency vs. Load Curves	10
6.4 Input Capacitance at the Power Module	14
6.5 Test Set-Up	14
6.6 Output Ripple and Noise Measurement	14
6.7 Output Capacitance	14
<b>7. SAFETY &amp; EMC</b>	<b>15</b>
7.1 Input Fusing and Safety Considerations.	15
7.2 EMC Considerations	15
<b>8. PART NUMBER</b>	<b>23</b>
<b>9. MECHANICAL SPECIFICATIONS</b>	<b>23</b>



# EC7A 10W Isolated DC-DC Converters

## Application Note V10 April 2010

### 1. Introduction

The EC7A series offer 10 watts of output power in a 24 pin DIP and SMD copper package. The EC7A series has a 2:1 wide input voltage range of 9-18VDC, 18-36VDC and 36-75VDC, and provides a precisely regulated output. This series has features such as high efficiency, 1500VDC of isolation and allows an ambient operating temperature range of  $-40^{\circ}\text{C}$  to  $85^{\circ}\text{C}$  ( de-rating above  $71^{\circ}\text{C}$ ). The modules are fully protected against input UVLO (under voltage lock out), output short circuit and output overvoltage conditions. All models are very suitable for distributed power architectures, telecommunications, battery operated equipment and industrial applications.

### 2. DC-DC Converter Features

- \* 10W Isolated Output
- \* DIP-24 / SMD Metal Package
- \* Efficiency Up to 89%
- \* 2 : 1 Input Range
- \* Regulated Outputs
- \* PI Input Filter
- \* Continuous Short Circuit Protection
- \* No Tantalum Capacitor Inside
- \* CE Mark Meets 2004/108/EC
- \* UL60950-1 Approval

### 3. Electrical Block Diagram

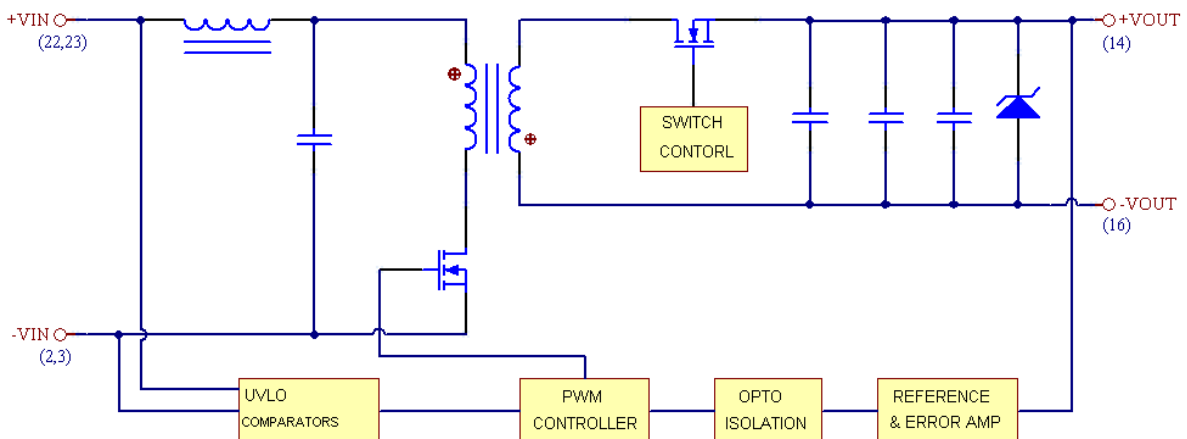

Figure 1 Electrical Block Diagram of single output module

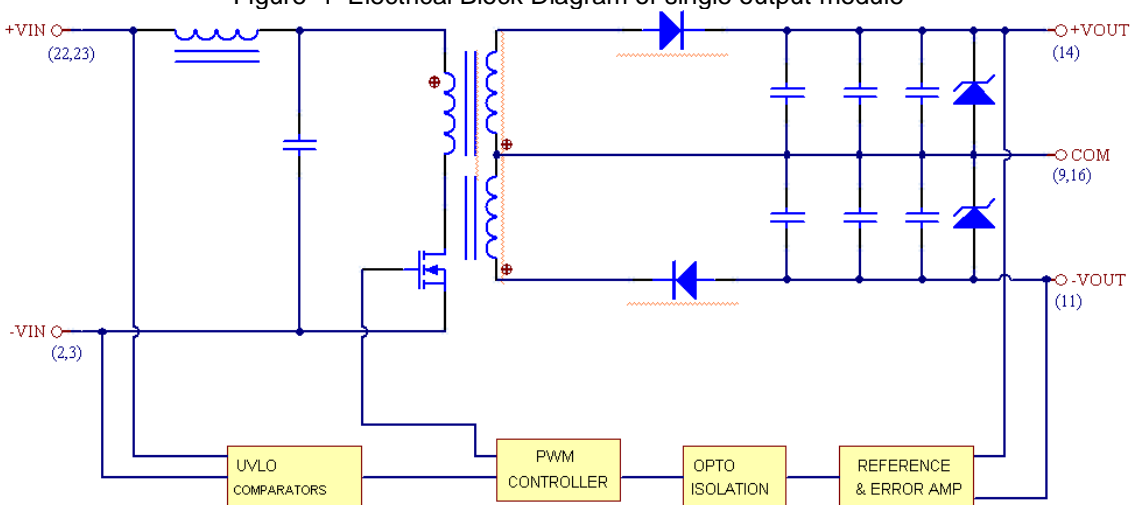

Figure 2 Electrical Block Diagram of dual output module



# EC7A 10W Isolated DC-DC Converters

## Application Note V10 April 2010

### 4. Technical Specifications

(All specifications are typical at nominal input, full load at 25°C unless otherwise noted.)

<b>ABSOLUTE MAXIMUM RATINGS</b>						
PARAMETER	NOTES and CONDITIONS	Device	Min.	Typical	Max.	Units
Input Voltage						
Continuous		12Vin	9	12	18	Vdc
		24Vin	18	24	36	
		48Vin	36	48	75	
Transient	100ms	12Vin			25	Vdc
		24Vin			50	
		48Vin			100	
Operating Ambient Temperature	With de-rating, above 71°C	All	-40		+85	°C
Case Temperature		All			100	°C
Storage Temperature		All	-40		+125	°C
Input/Output Isolation Voltage	1 minute	All			1500	Vdc
<b>INPUT CHARACTERISTICS</b>						
PARAMETER	NOTES and CONDITIONS	Device	Min.	Typical	Max.	Units
Operating Input Voltage		12Vin	9	12	18	Vdc
		24Vin	18	24	36	
		48Vin	36	48	75	
Turn-On Voltage Threshold		12Vin	8	8.5	8.8	Vdc
		24Vin	16.5	17	17.5	
		48Vin	33	34	34.5	
Turn-Off Voltage Threshold		12Vin	7.7	8	8.3	Vdc
		24Vin	15.5	16	16.5	
		48Vin	31.5	32.5	33	
Lockout Hysteresis Voltage		12Vin		0.6		
		24Vin		0.9		
		48Vin		1.8		
Maximum Input Current	100% Load, Vin= 9V	12Vin		1000		mA
	100% Load, Vin=18V	24Vin		500		
	100% Load, Vin=36V	48Vin		250		
No-Load Input Current	Vin=12V	12S25		40		mA
		12S33		50		
		12S05		60		
		12S12		40		
		12S15		40		
		12D12		30		
		12D15		30		
	Vin=24V	24S25		30		
		24S33		30		
		24S05		30		
		24S12		30		
		24S15		30		
		24D12		20		
	Vin=48V	24D15		20		
		48S25		15		
		48S33		15		
		48S05		15		
		48S12		15		
48S15		15				
48D12		10				
48D15		10				



# EC7A 10W Isolated DC-DC Converters

## Application Note V10 April 2010

Inrush Current ( $I^2t$ )		All			0.01	$A^2s$
Input Reflected-Ripple Current	P-P thru 1uH inductor, 5Hz to 20MHz	All		30		mA
<b>OUTPUT CHARACTERISTIC</b>						
<b>PARAMETER</b>	<b>NOTES and CONDITIONS</b>	Device	Min.	Typical	Max.	Units
Output Voltage Set Point	$V_{in}$ =nominal input, $I_o=I_{o,max}$ .	$V_o=2.5V_{dc}$	2.4625	2.5	2.5375	Vdc
		$V_o=3.3V_{dc}$	3.2505	3.3	3.3495	
		$V_o=5V_{dc}$	4.925	5	5.075	
		$V_o=12V_{dc}$	11.82	12	12.18	
		$V_o=15V_{dc}$	14.775	15	15.225	
		$V_o=\pm 12V_{dc}$	$\pm 11.82$	$\pm 12$	$\pm 12.18$	
		$V_o=\pm 15V_{dc}$	$\pm 14.775$	$\pm 15$	$\pm 15.225$	
Output Voltage Balance	$V_{in}$ =nominal input, $I_o=I_{o,max}$ .	Dual			$\pm 2.0$	%
Output Voltage Regulation						
Load Regulation	$I_o$ =full load to 10% load	Single(DIP)			$\pm 0.5$	%
		Single(SMD)			$\pm 1.0$	
		Dual			$\pm 1.0$	
Line Regulation	$V_{in}$ =low line to high line, full load	Single			$\pm 0.2$	%
		Dual			$\pm 0.5$	
Temperature Coefficient	$T_a=-40^\circ C$ to $85^\circ C$				$\pm 0.05$	$\%/^\circ C$
Output Voltage Ripple and Noise (5Hz to 20MHz bandwidth)						
Peak-to-Peak	Full Load, 0.1uF ceramic capacitor	$V_o=2.5V_{dc}$			75	mV
		$V_o=3.3V_{dc}$				
		$V_o=5V_{dc}$				
		$V_o=12V_{dc}$			100	
		$V_o=15V_{dc}$				
		$V_o=\pm 12V_{dc}$				
		$V_o=\pm 15V_{dc}$				
Operating Output Current Range		$V_o=2.5V_{dc}$	0		3000	mA
		$V_o=3.3V_{dc}$	0		3000	
		$V_o=5V_{dc}$	0		2000	
		$V_o=12V_{dc}$	0		835	
		$V_o=15V_{dc}$	0		666	
		$V_o=\pm 12V_{dc}$	0		$\pm 416$	
		$V_o=\pm 15V_{dc}$	0		$\pm 333$	
Output DC Current-Limit Inception	$V_o=90\% V_{O,nominal}$		120			%
Maximum Output Capacitance	Full load (resistive)	$V_o=2.5V_{dc}$			3000	uF
		$V_o=3.3V_{dc}$			3000	
		$V_o=5V_{dc}$			2000	
		$V_o=12V_{dc}$			835	
		$V_o=15V_{dc}$			666	
		$V_o=\pm 12V_{dc}$			416	
		$V_o=\pm 15V_{dc}$			333	
<b>DYNAMIC CHARACTERISTICS</b>						
<b>PARAMETER</b>	<b>NOTES and CONDITIONS</b>	Device	Min.	Typical	Max.	Units
Output Voltage Current Transient						
Step Change in Output Current	75% to 100% of $I_{o,max}$	All			$\pm 5$	%
Setting Time (within 1% $V_{out}$ nominal)	$di/dt=0.1A/us$	All			300	us
Turn-On Delay and Rise Time						
Turn-On Delay Time, From Input	$V_{in,min.}$ to $10\%V_{o,set}$	24(48)S25 (33)		1		ms
		24(48)S05 (12)		2		ms
		others		5		ms



# EC7A 10W Isolated DC-DC Converters

## Application Note V10 April 2010

Output Voltage Rise Time	10%Vo,set to 90%Vo,set	24(48)S25 (33)		110		ms
		24(48)S05 (12)		65		ms
		others		5		ms

### EFFICIENCY

PARAMETER	NOTES and CONDITIONS	Device	Min.	Typical	Max.	Units
100% Load	Vin=12V	12S25		85		%
		12S33		85		
		12S05		88		
		12S12		88		
		12S15		88		
		12D12		87		
	12D15		86			
	Vin=24V	24S25		85		
		24S33		86		
		24S05		88		
		24S12		89		
		24S15		88		
		24D12		89		
	Vin=48V	48S25		85		
		48S33		85		
		48S05		88		
		48S12		89		
		48S15		88		
48D12			88			
48D15		86				

### ISOLATION CHARACTERISTICS

PARAMETER	NOTES and CONDITIONS	Device	Min.	Typical	Max.	Units
Isolation Voltage	Input to Output, 1 minutes	All			1500	Vdc
Isolation Resistance	Input to Output	All			1000	MΩ
Isolation Capacitance	Input to Output	All		1000		pF

### FEATURE CHARACTERISTICS

PARAMETER	NOTES and CONDITIONS	Device	Min.	Typical	Max.	Units
Switching Frequency		All		380		KHz
Output Over Voltage Protection	Zener or TVS Clamp	Vo=2.5V		3.9		V
		Vo=3.3V		3.9		
		Vo=5.0V		6.2		
		Vo=12V		15		
		Vo=15V		18		

### GENERAL SPECIFICATIONS

PARAMETER	NOTES and CONDITIONS	Device	Min.	Typical	Max.	Units
MTBF	Io=100% of Io.max; Ta=25°C per MIL-HDBK-217F	ALL		1.15		M hours
Weight		ALL		18.4		grams



# EC7A 10W Isolated DC-DC Converters

## Application Note V10 April 2010

---

### **5. Main Features and Functions**

#### **5.1 Operating Temperature Range**

The EC7A series converters can be operated by a wide ambient temperature range from  $-40^{\circ}\text{C}$  to  $85^{\circ}\text{C}$  (de-rating above  $71^{\circ}\text{C}$ ). The standard model has a copper case and case temperature can not over  $100^{\circ}\text{C}$  at normal operating.

#### **5.2 UVLO (Under Voltage Lock Out)**

Input under voltage lockout is standard on the EC7A unit. The unit will shut down when the input voltage drops below a threshold, and the unit will operate when the input voltage goes above the upper threshold.

#### **5.3 Over Current Protection**

All models have internal over current and continuous short circuit protection. The unit operates normally once the fault condition is removed. At the point of current limit inception, the converter will go into hiccup mode protection.

#### **5.4 Over Voltage Protection**

The over-voltage protection consists of a zener diode to limiting the out voltage.



# EC7A 10W Isolated DC-DC Converters

## Application Note V10 April 2010

### 6. Applications

#### 6.1 Recommended Layout PCB Footprints and Soldering Information

The system designer or the end user must ensure that other components and metal in the vicinity of the converter meet the spacing requirements to which the system is approved. Low resistance and low inductance PCB layout traces are the norm and should be used where possible. Due consideration must also be given to proper low impedance tracks between power module, input and output grounds. The recommended footprints and soldering profiles are shown below.

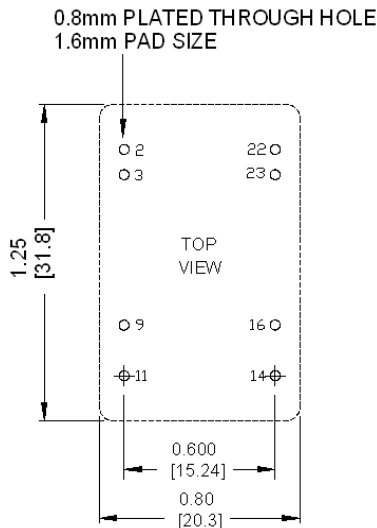

Note: Dimensions are in inches (millimeters)

Lead Free Wave Soldering Profile

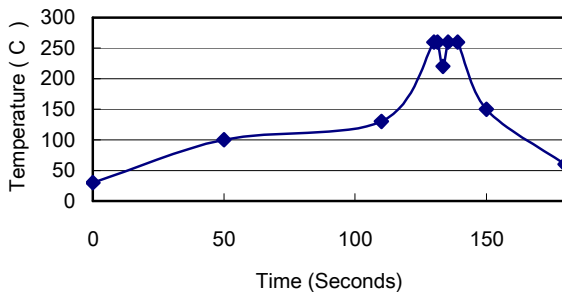

Note :

1. Soldering Materials: Sn/Cu/Ni
2. Ramp up rate during preheat: 1.4 °C/Sec (From 50°C to 100°C)
3. Soaking temperature: 0.5 °C/Sec (From 100°C to 130°C), 60±20 seconds
4. Peak temperature: 260°C, above 250°C 3-6 Seconds
5. Ramp up rate during cooling: -10.0 °C/Sec (From 260°C to 150°C)

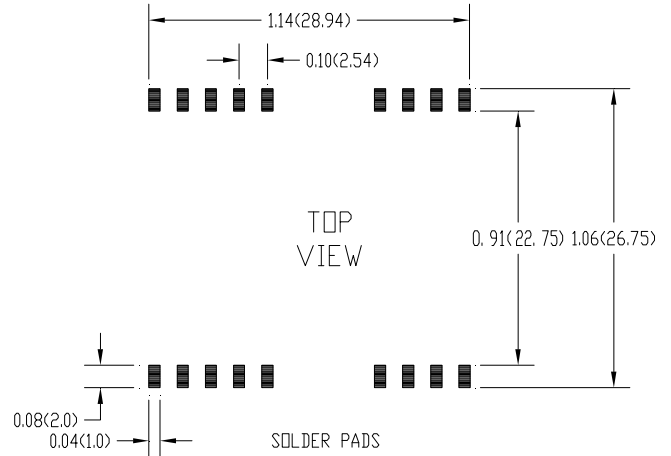

Lead Free Hot Air Reflow Profile

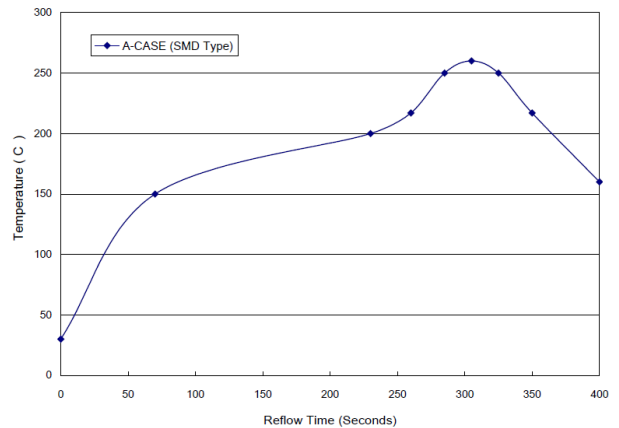

1. Soldering Paste: SHENMAO PF610-P (Sn/Ag/Cu)
2. Ramp up rate during preheat: 1.71 °C/Sec (From 30°C to 150°C)
3. Soaking temperature: 0.31 °C/Sec (From 150°C to 200°C), 160±10 seconds
4. Ramp up rate during reflow: 0.96 °C/Sec (From 217°C to 260°C)
5. Peak temperature: 260°C, above 217°C 90 Seconds
6. Ramp up rate during cooling: -1.2 °C/Sec (From 260°C to 160°C)

Figure 3 Recommended PCB Layout Footprints and Wave Soldering Profiles for DIP-24 and SMD packages





# EC7A 10W Isolated DC-DC Converters

## Application Note V10 April 2010

### 6.2 Power De-Rating Curves for EC7A Series

Operating Ambient temperature Range:  $-40^{\circ}\text{C} \sim 85^{\circ}\text{C}$  with de-rating above  $71^{\circ}\text{C}$ .

Maximum case temperature under any operating condition should not exceed  $100^{\circ}\text{C}$ .

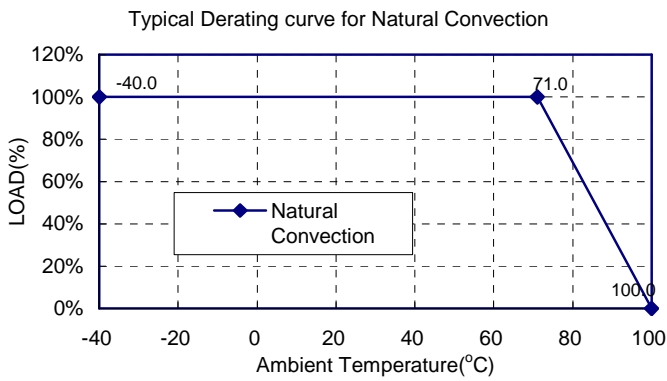



# EC7A 10W Isolated DC-DC Converters

## Application Note V10 April 2010

### 6.3 Efficiency vs. Load Curves

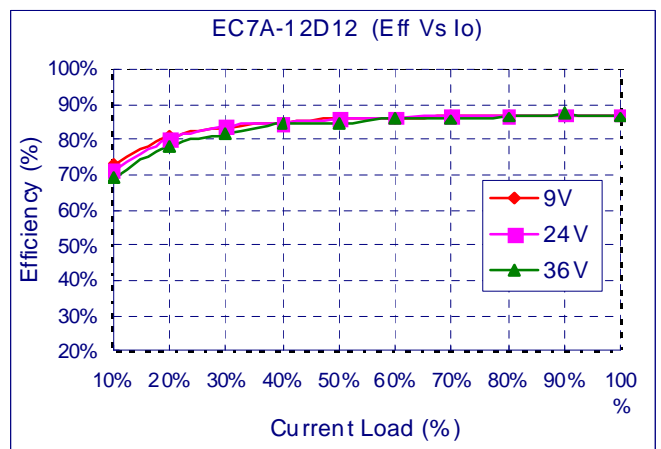
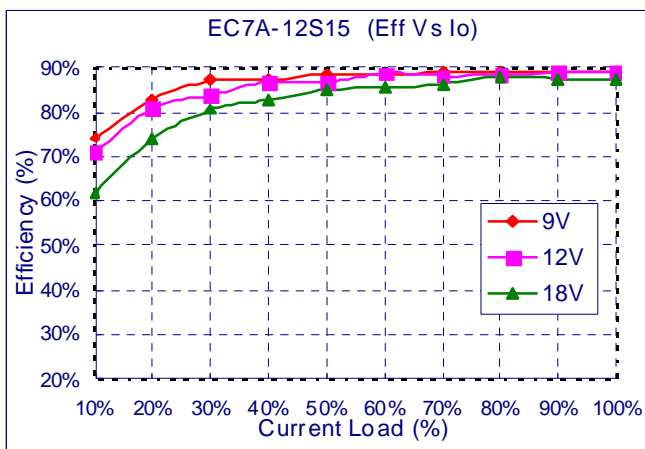
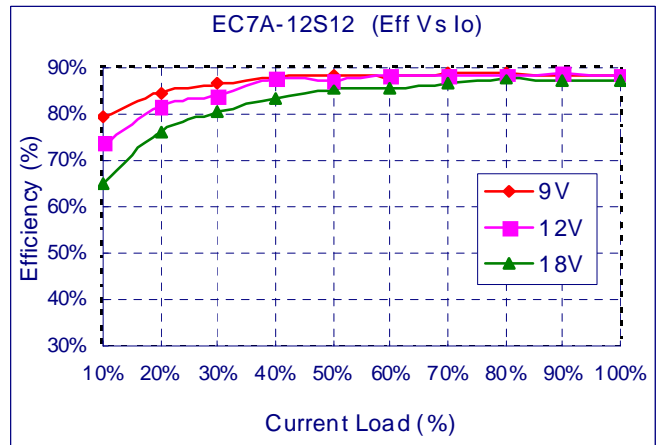
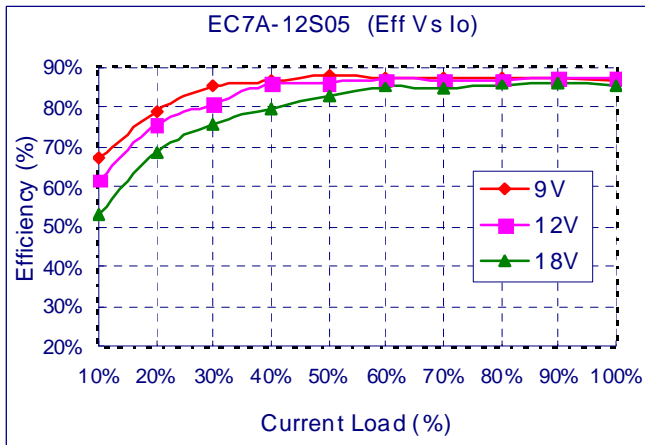
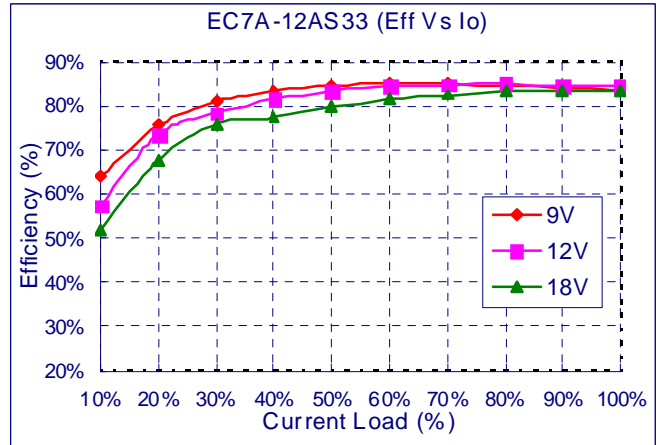
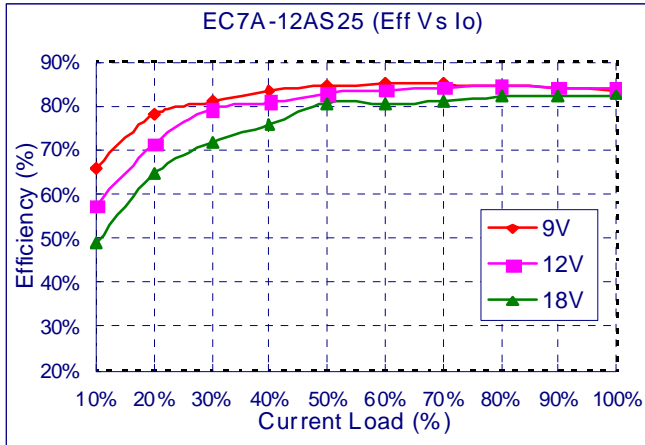



# EC7A 10W Isolated DC-DC Converters

## Application Note V10 April 2010

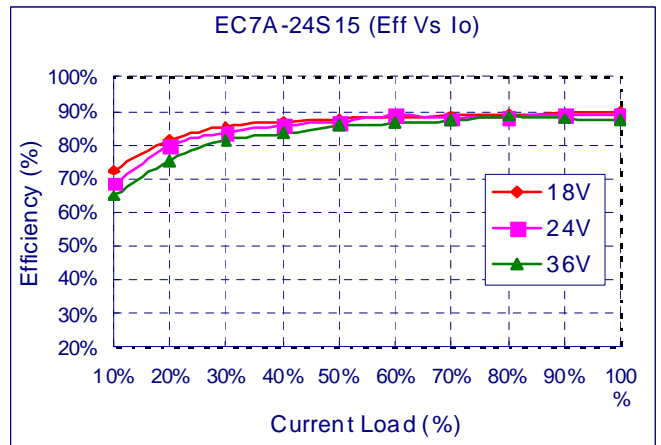
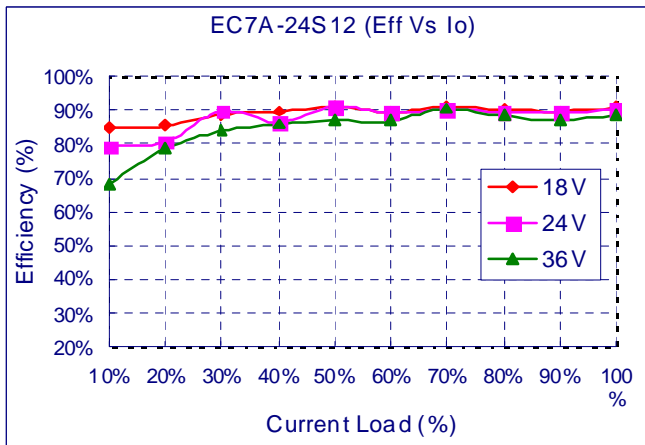
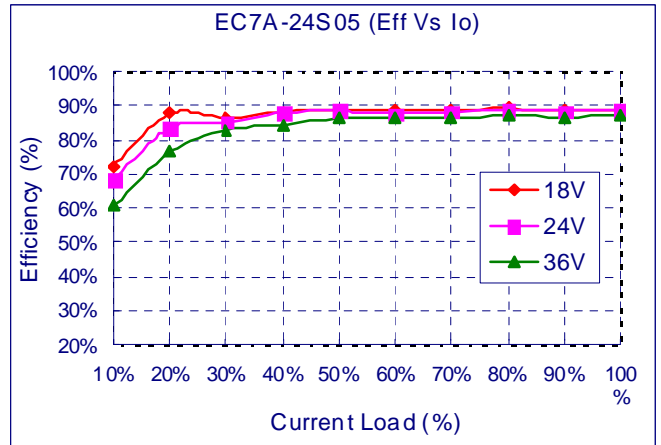
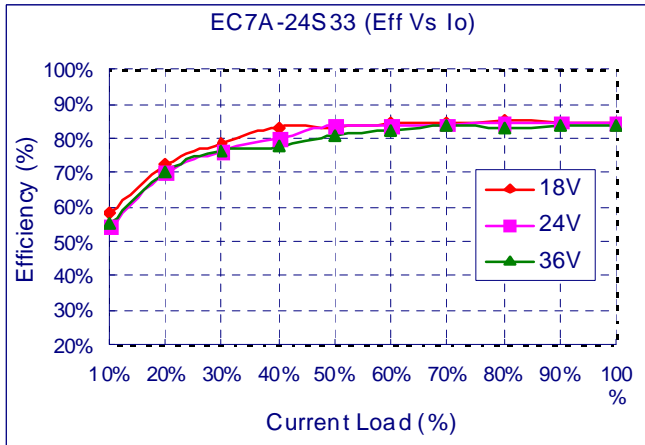
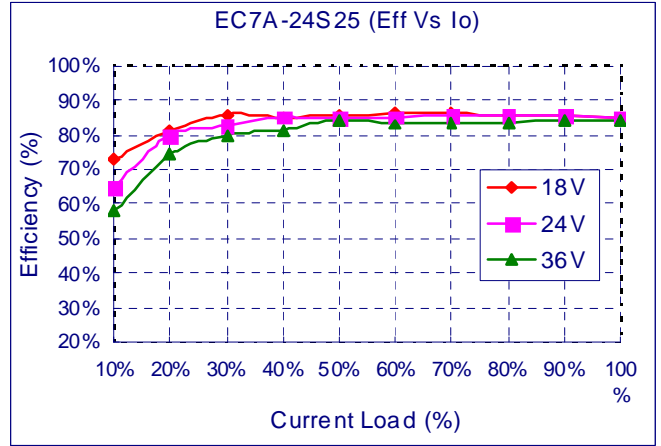
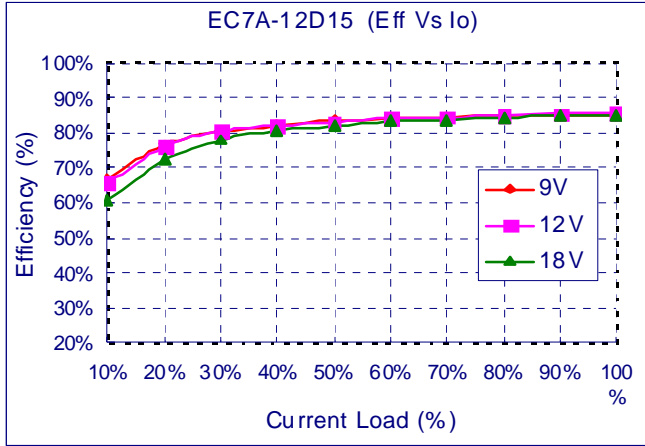



# EC7A 10W Isolated DC-DC Converters

## Application Note V10 April 2010

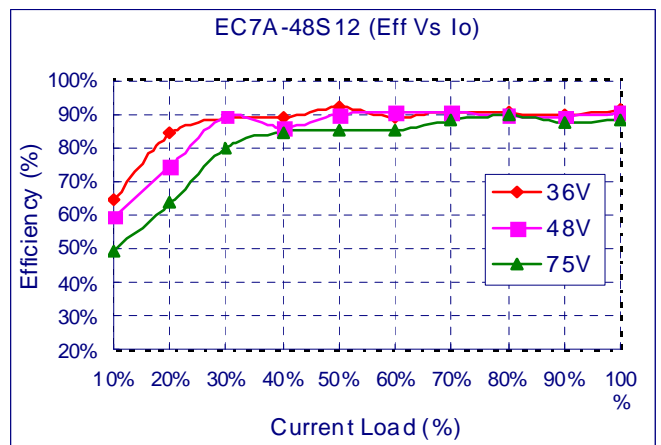
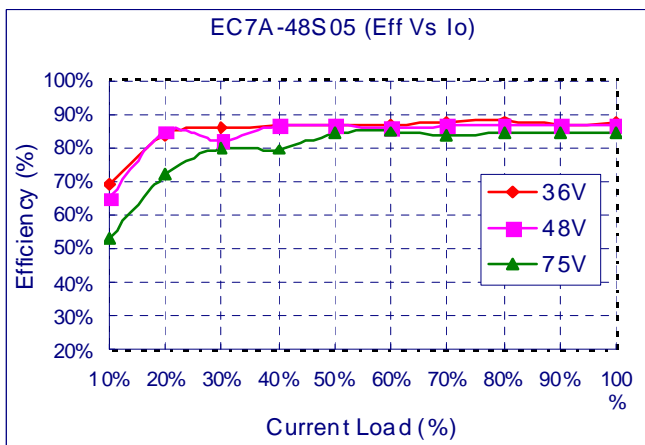
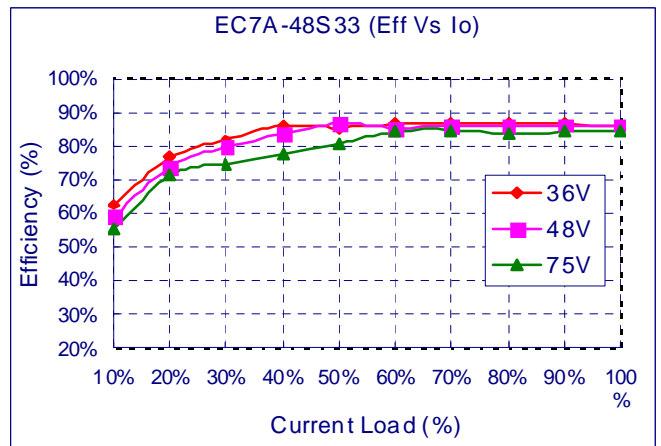
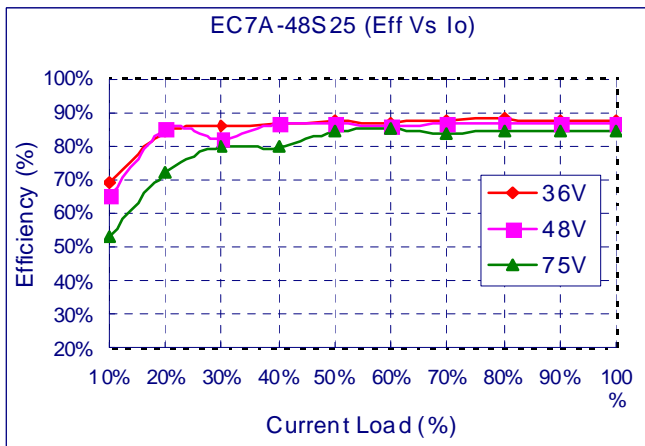
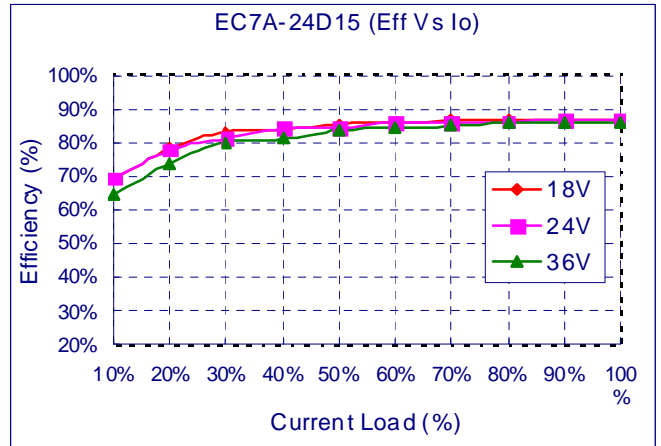
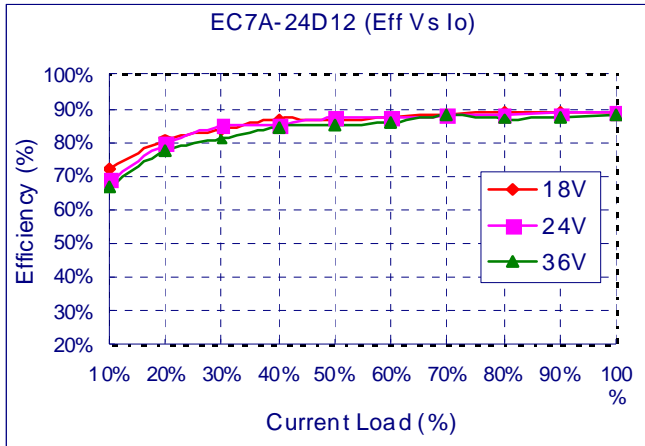



# EC7A 10W Isolated DC-DC Converters

## Application Note V10 April 2010

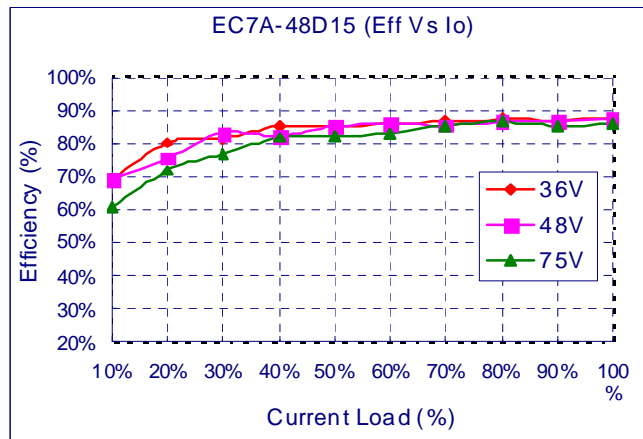
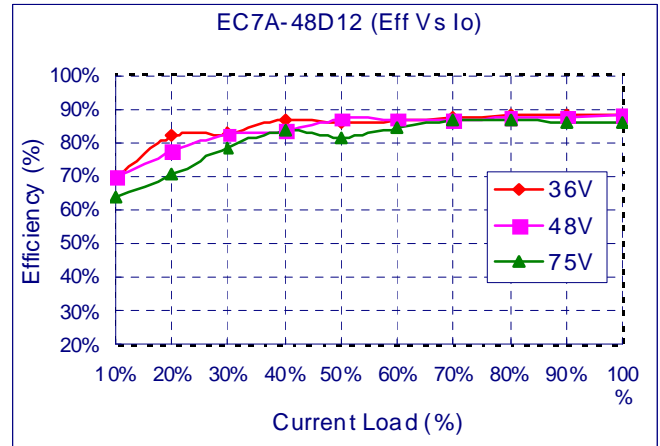
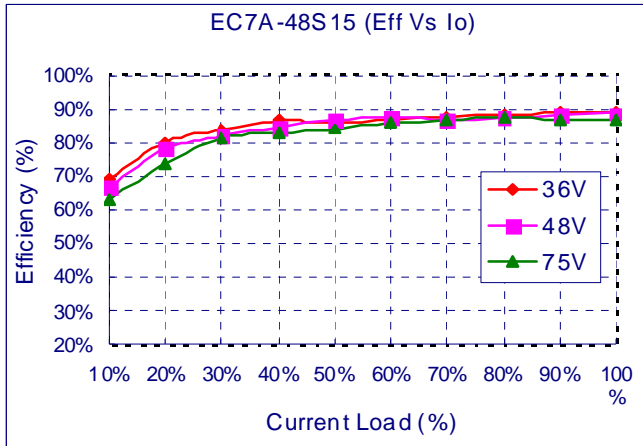



# EC7A 10W Isolated DC-DC Converters

## Application Note V10 April 2010

### 6.4 Input Capacitance at the Power Module

The converters must be connected to low AC source impedance. To avoid problems with loop stability source inductance should be low. Also, the input capacitors (Cin) should be placed close to the converter input pins to de-couple distribution inductance. However, the external input capacitors are chosen for suitable ripple handling capability. Low ESR capacitors are good choice. Circuit as shown in Figure 4 represents typical measurement methods for reflected ripple current. C1 and L1 simulate a typical DC source impedance. The input reflected-ripple current is measured by current probe to oscilloscope with a simulated source inductance (L1).

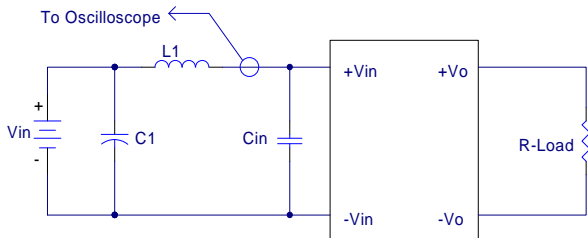

L1: 1uH.  
C1: None  
Cin: 6.8uF Ceramic capacitor.

Figure 4 Input Reflected-Ripple Test Setup

### 6.5 Test Set-Up

The basic test set-up to measure parameters such as efficiency and load regulation is shown in Figure 5. When testing the modules under any transient conditions please ensure that the transient response of the source is sufficient to power the equipment under test. We can calculate the

- Efficiency
- Load regulation and line regulation.

The value of efficiency is defined as:

$$\eta = \frac{V_o \times I_o}{V_{in} \times I_{in}} \times 100\%$$

Where

Vo is output voltage,  
Io is output current,  
Vin is input voltage,  
Iin is input current.

The value of load regulation is defined as:

$$Load.reg = \frac{V_{FL} - V_{NL}}{V_{NL}} \times 100\%$$

Where

V<sub>FL</sub> is the output voltage at full load  
V<sub>NL</sub> is the output voltage at 10% load

The value of line regulation is defined as:

$$Line.reg = \frac{V_{HL} - V_{LL}}{V_{LL}} \times 100\%$$

Where

V<sub>HL</sub> is the output voltage of maximum input voltage at full load.

V<sub>LL</sub> is the output voltage of minimum input voltage at full load.

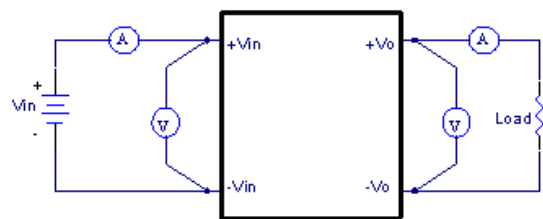
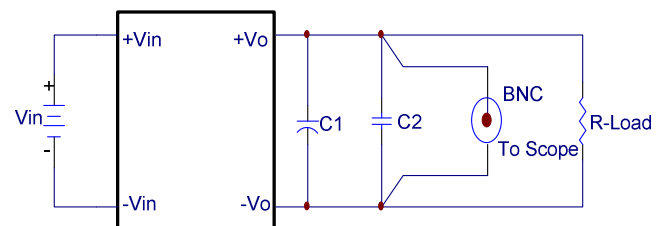

Figure 5 EC7A Series Test Setup

### 6.6 Output Ripple and Noise Measurement

The test set-up for noise and ripple measurements is shown in Figure 6. A coaxial cable was used to prevent impedance mismatch reflections disturbing the noise readings at higher frequencies. Measurements are taken with output appropriately loaded and all ripple/noise specifications are from 5Hz to 20MHz Band Width.



Note: C1: None  
C2: 0.1uF Ceramic capacitor

Figure 6 Output Voltage Ripple and Noise Measurement Set-Up

### 6.7 Output Capacitance

The EC7A series converters provide unconditional stability with or without external capacitors. For good transient response low ESR output capacitors should be located close to the point of load. These series converters are designed to work with load capacitance to see technical specifications.



# EC7A 10W Isolated DC-DC Converters

## Application Note V10 April 2010

### 7. Safety & EMC

#### 7.1 Input Fusing and Safety Considerations.

The EC7A series converters have not an internal fuse. However, to achieve maximum safety and system protection, always use an input line fuse. We recommended a time delay fuse 3A for 12Vin models, 2A for 24Vin models and 1A for 48Vin modules. Figure 7 circuit is recommended by a Transient Voltage Suppressor diode across the input terminal to protect the unit against surge or spike voltage and input reverse voltage.

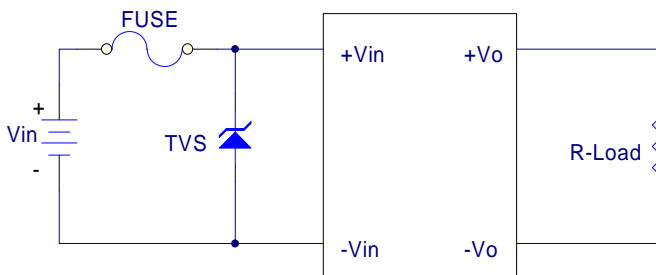

Figure 7 Input Protection

#### 7.2 EMC Considerations

EMI Test standard: EN55022

Test Condition: Input Voltage: Nominal, Output Load: Full Load

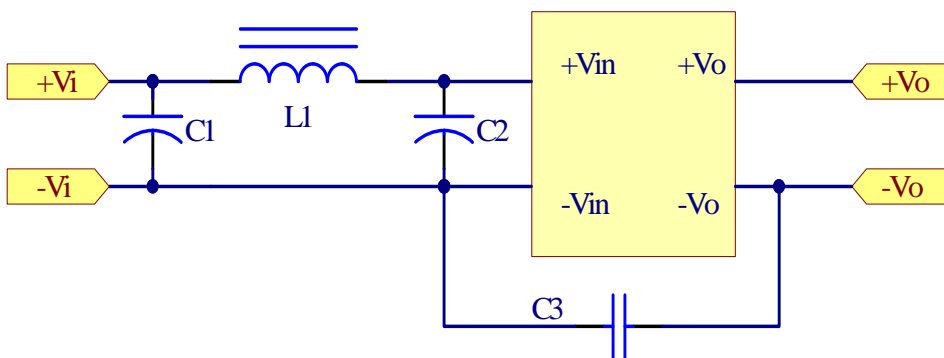

Figure 8 Connection circuit for conducted EMI testing



# EC7A 10W Isolated DC-DC Converters

## Application Note V10 April 2010

Model No.	EN55022 Class A				EN55022 Class B			
	C1	C2	C3	L1	C1	C2	C3	L1
EC7A-12S25	NC	NC	NC	Short	22uF/50V KY ESR<0.7Ω	NC	NC	3.5uH
EC7A-12S33	NC	NC	NC	Short	22uF/50V KY ESR<0.7Ω	NC	NC	3.5uH
EC7A-12S05	NC	NC	NC	Short	22uF/50V KY ESR<0.7Ω	NC	NC	3.5uH
EC7A-12S12	NC	NC	NC	Short	22uF/50V KY ESR<0.7Ω	NC	NC	3.5uH
EC7A-12S15	NC	NC	NC	Short	22uF/50V KY ESR<0.7Ω	NC	NC	3.5uH
EC7A-12D12	NC	NC	NC	Short	47uV/25V KY	NC	NC	8uH
EC7A-12D15	NC	NC	NC	Short	47uV/25V KY	NC	NC	8uH
EC7A-24S25	22uF/50V KY ESR<0.7Ω	NC	NC	0.7uH	22uF/50V KY ESR<0.7Ω	NC	NC	3.5uH
EC7A-24S33	22uF/50V KY ESR<0.7Ω	NC	NC	0.7uH	22uF/50V KY ESR<0.7Ω	NC	NC	3.5uH
EC7A-24S05	22uF/50V KY ESR<0.7Ω	NC	NC	0.7uH	22uF/50V KY ESR<0.7Ω	NC	NC	3.5uH
EC7A-24S12	22uF/50V KY ESR<0.7Ω	NC	NC	0.7uH	22uF/50V KY ESR<0.7Ω	NC	NC	3.5uH
EC7A-24S15	22uF/50V KY ESR<0.7Ω	NC	NC	0.7uH	22uF/50V KY ESR<0.7Ω	NC	NC	3.5uH
EC7A-24D12	NC	NC	NC	Short	22uF/50V KY	NC	NC	8uH
EC7A-24D15	NC	NC	NC	Short	22uF/50V KY	NC	NC	8uH
EC7A-48S25	22uF/100V KMF ESR<0.66Ω	NC	NC	0.7uH	22uF/100V KMF ESR<0.66Ω	NC	NC	3.5uH
EC7A-48S33	22uF/100V KMF ESR<0.66Ω	NC	NC	0.7uH	22uF/100V KMF ESR<0.66Ω	NC	NC	3.5uH
EC7A-48S05	22uF/100V KMF ESR<0.66Ω	NC	NC	0.7uH	22uF/100V KMF ESR<0.66Ω	NC	NC	3.5uH
EC7A-48S12	22uF/100V KMF ESR<0.66Ω	NC	NC	0.7uH	22uF/100V KMF ESR<0.66Ω	NC	NC	3.5uH
EC7A-48S15	22uF/100V KMF ESR<0.66Ω	NC	NC	0.7uH	22uF/100V KMF ESR<0.66Ω	NC	NC	3.5uH
EC7A-48D12	NC	NC	NC	Short	10uF/100V KMF	NC	680pF/3KV	8uH
EC7A-48D15	NC	NC	NC	Short	10uF/100V KMF	NC	NC	8uH





# EC7A 10W Isolated DC-DC Converters

## Application Note V10 April 2010

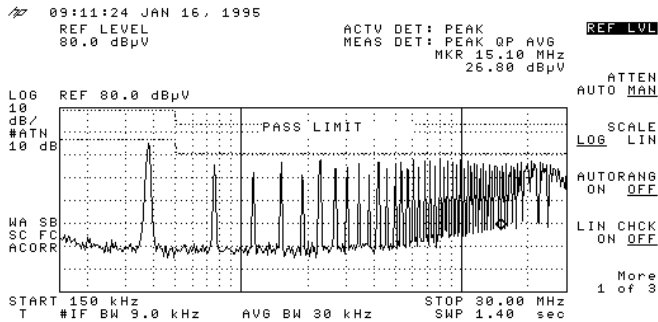

Conducted Class A of EC7A -12S25

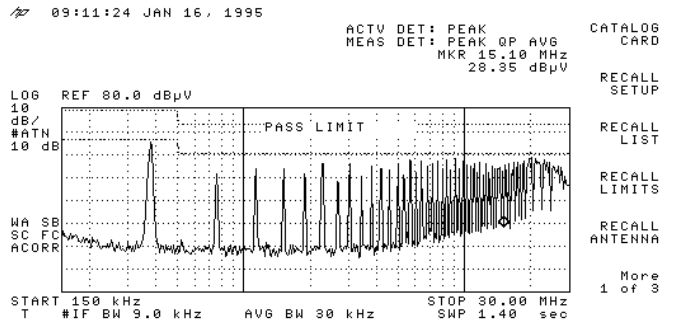

Conducted Class A EC7A -12S33

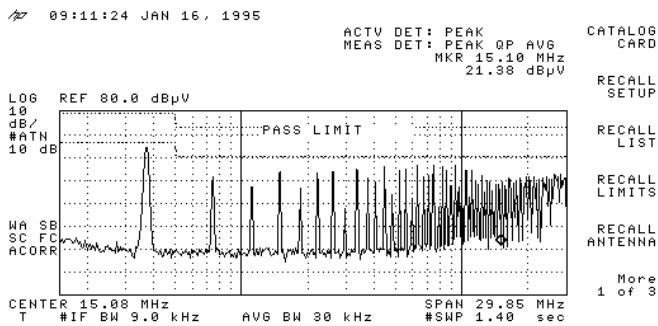

Conducted Class A EC7A -12S05

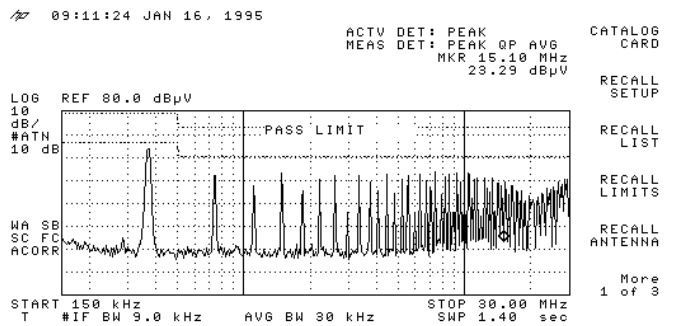

Conducted Class A EC7A -12S12

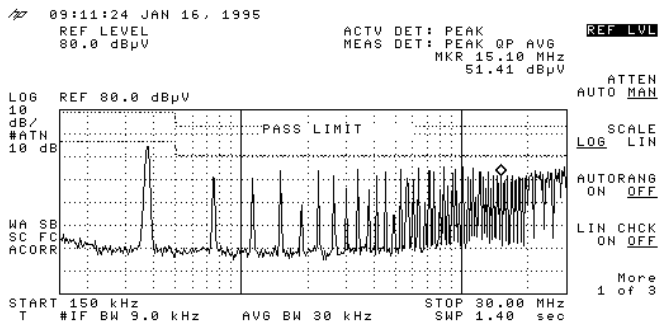

Conducted Class A of EC7A -12S15

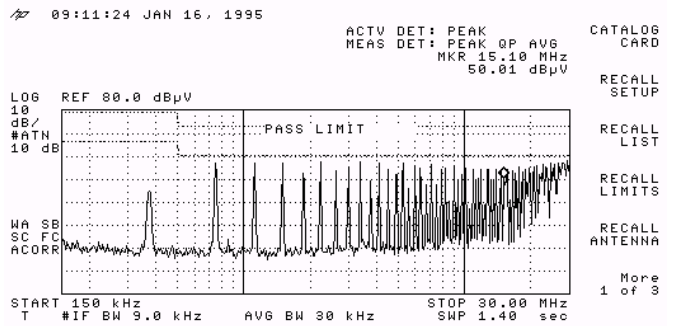

Conducted Class A of EC7A-12D12

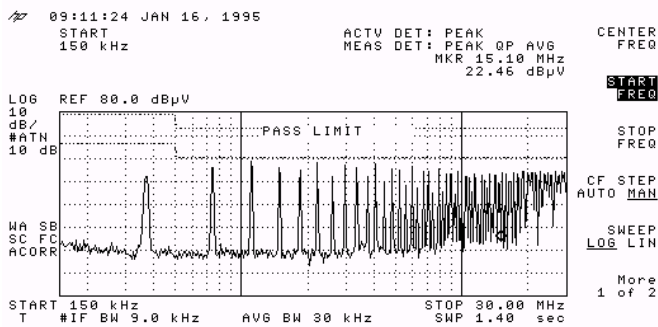

Conducted Class A EC7A-12D15

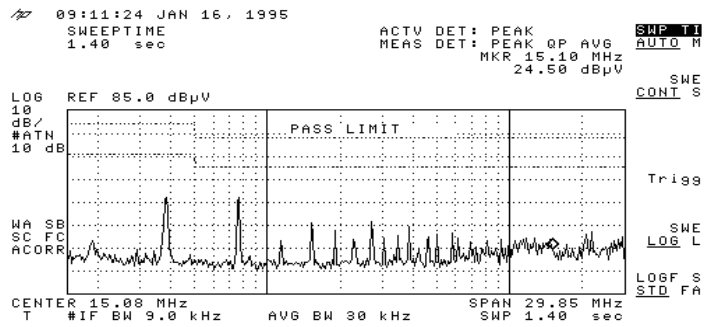

Conducted Class A EC7A -24S25



# EC7A 10W Isolated DC-DC Converters

## Application Note V10 April 2010

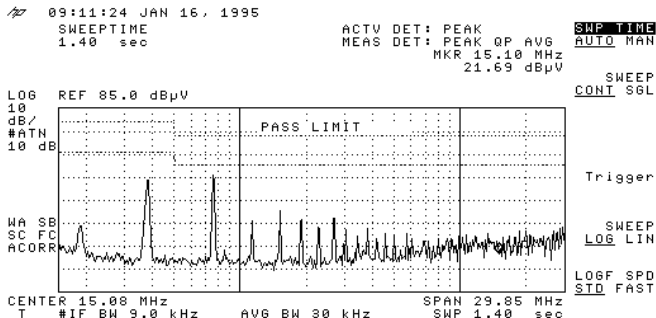

Conducted Class A EC7A-24S33

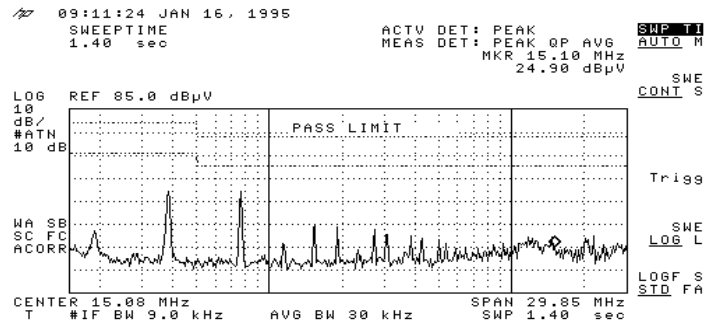

Conducted Class A EC7A -24S05

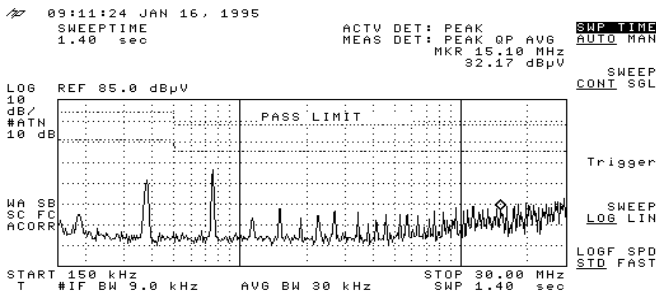

Conducted Class A of EC7A -24S12

TBD  
 Conducted Class A of EC7A -24S15

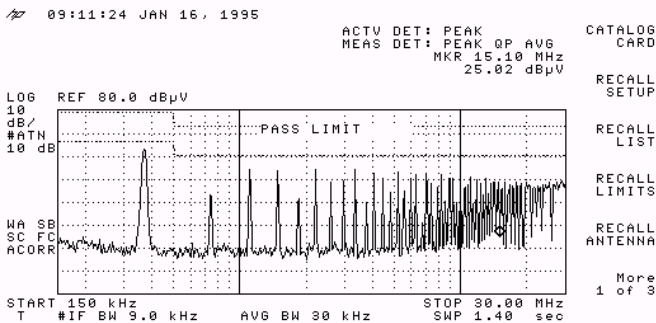

Conducted Class A EC7A -24D12

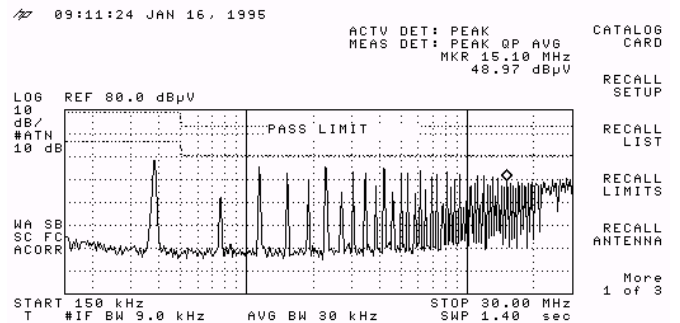

Conducted Class A EC7A -24D15

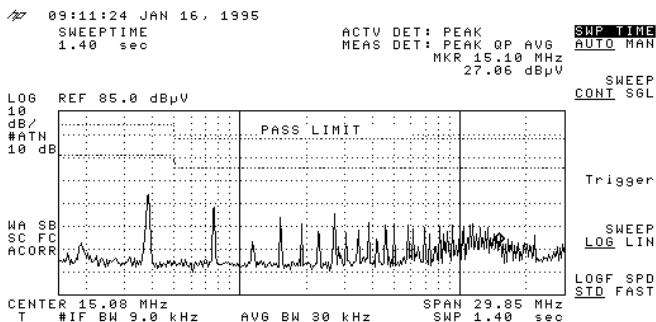

Conducted Class A EC7A -48S25

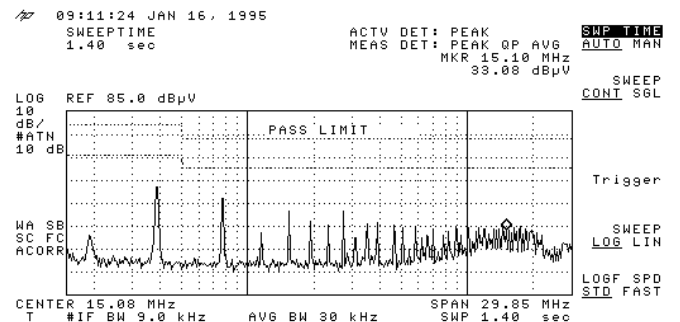

Conducted Class A EC7A -48S33



# EC7A 10W Isolated DC-DC Converters

## Application Note V10 April 2010

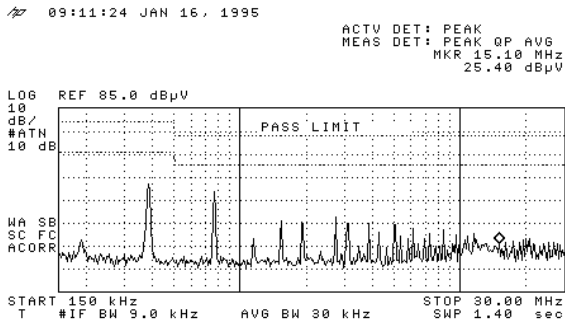

Conducted Class A of EC7A-48S05

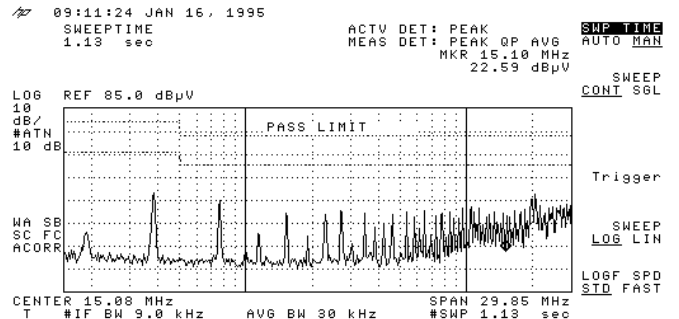

Conducted Class A EC7A -48S12

TBD  
Conducted Class A EC7A -48S15

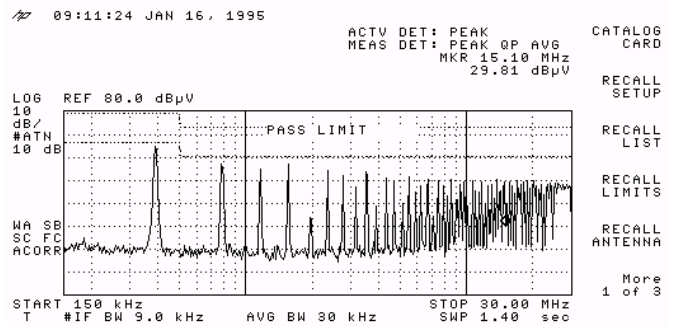

Conducted Class A of EC7A -48D12

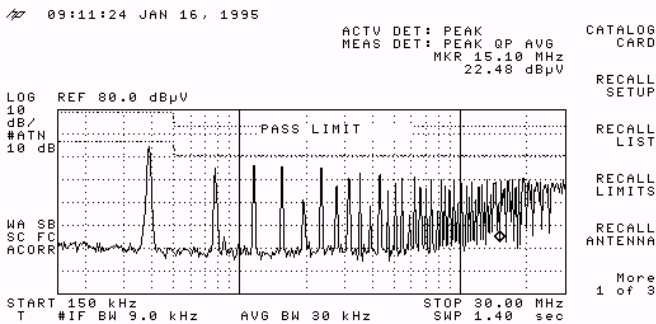

Conducted Class A EC7A -48D15



# EC7A 10W Isolated DC-DC Converters

## Application Note V10 April 2010

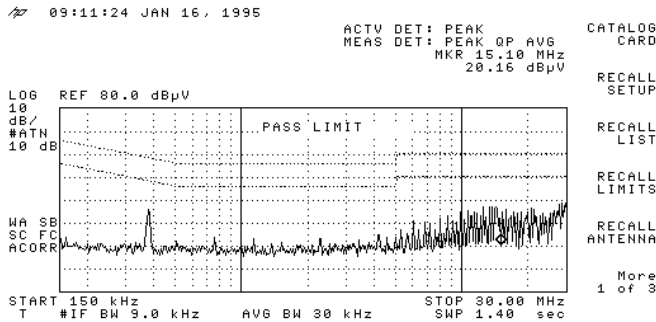

Conducted Class B of EC7A -12S25

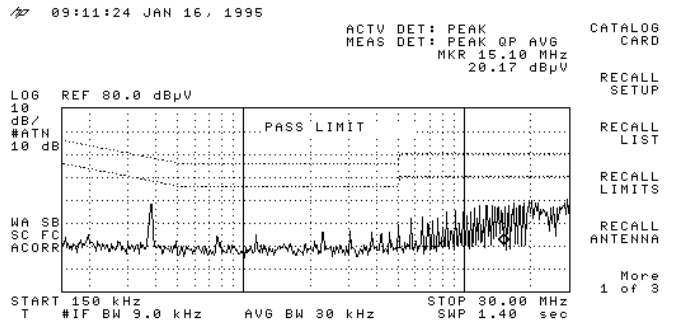

Conducted Class B EC7A -12S33

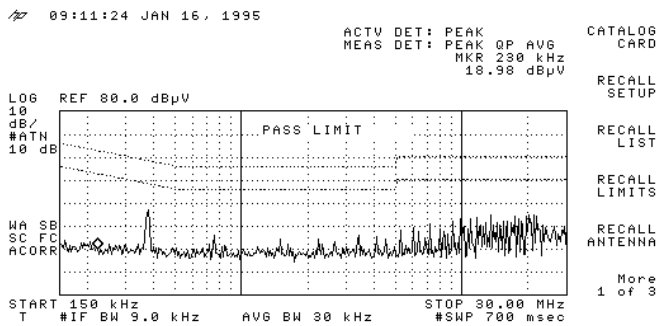

Conducted Class B EC7A -12S05

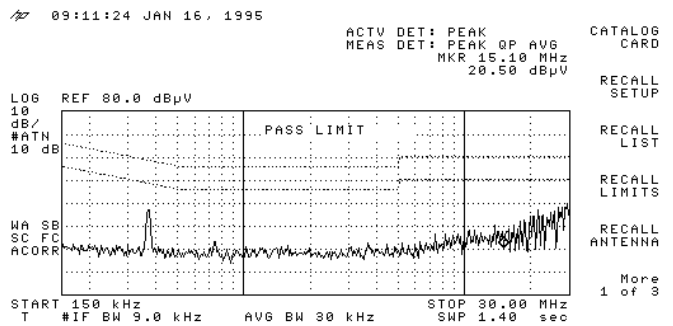

Conducted Class B EC7A -12S12

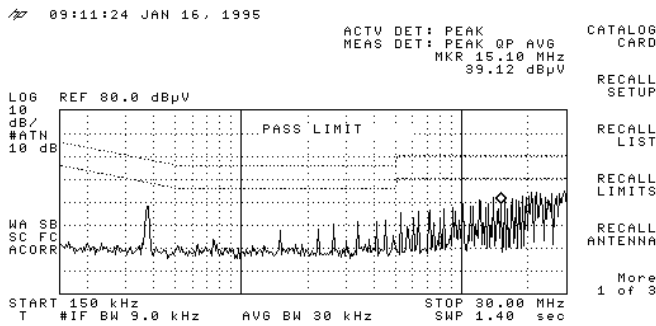

Conducted Class B of EC7A -12S15

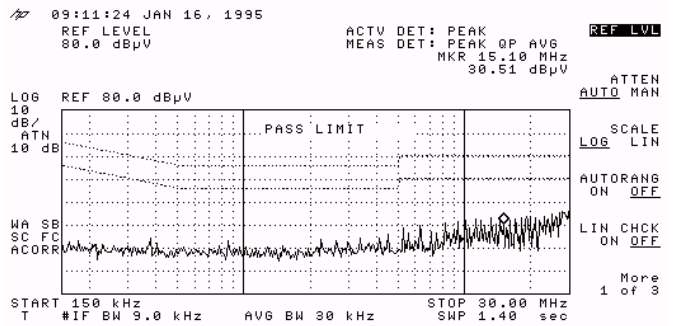

Conducted Class B of EC7A-12D12

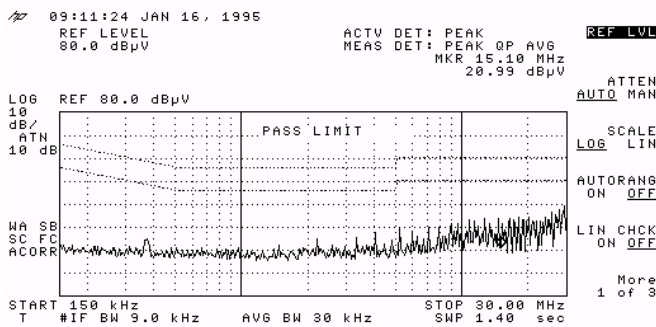

Conducted Class B EC7A-12D15

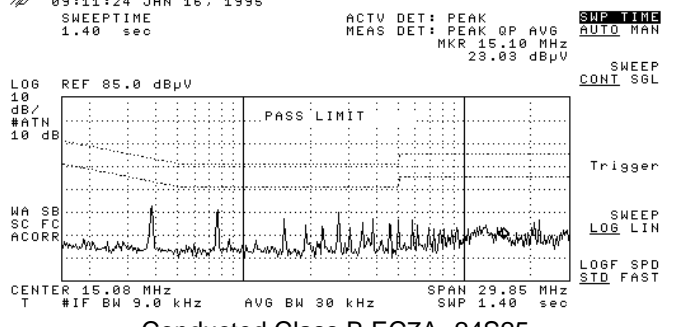

Conducted Class B EC7A -24S25



# EC7A 10W Isolated DC-DC Converters

## Application Note V10 April 2010

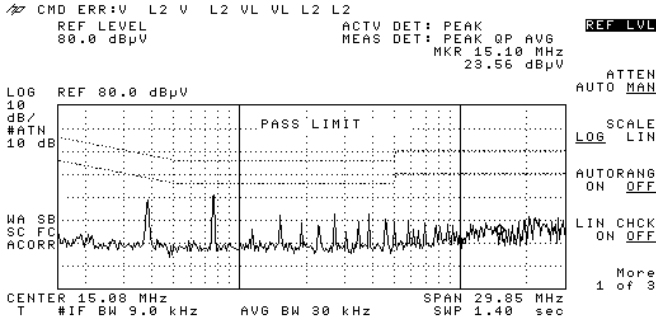

Conducted Class B EC7A-24S33

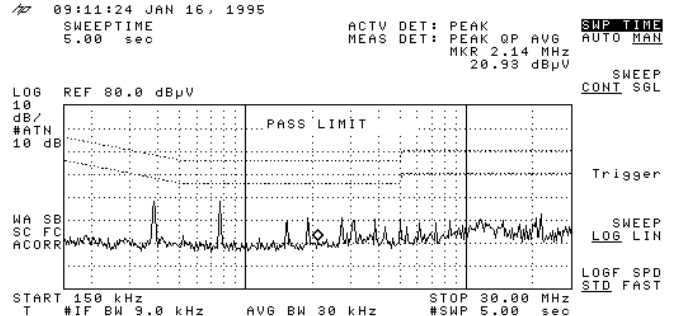

Conducted Class B EC7A -24S05

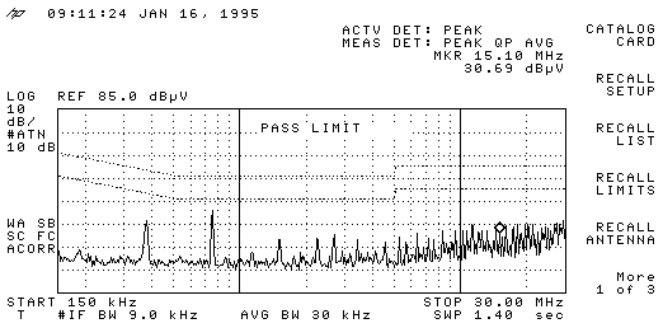

Conducted Class B of EC7A -24S12

TBD  
Conducted Class B of EC7A -24S15

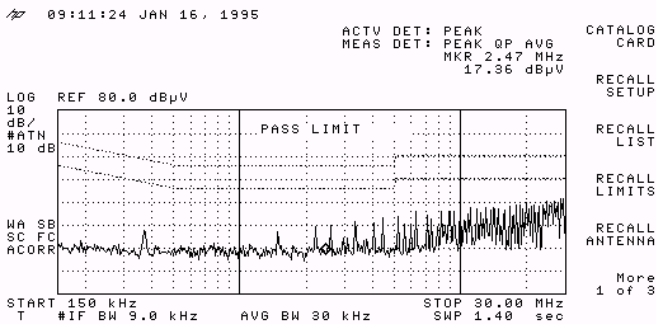

Conducted Class B EC7A -24D12

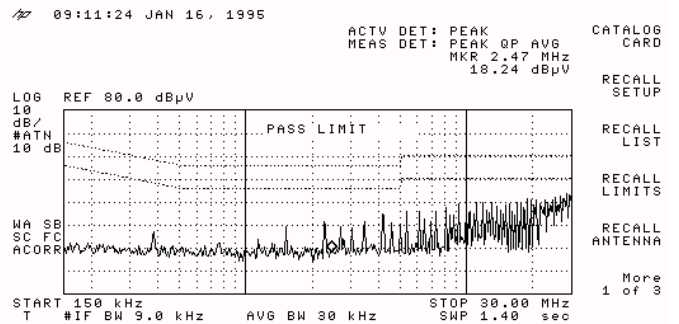

Conducted Class B EC7A -24D15

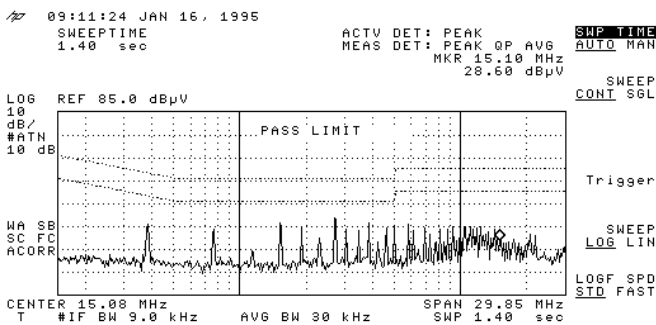

Conducted Class B EC7A -48S25

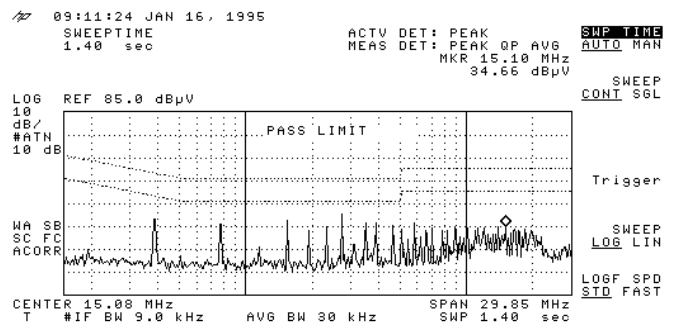

Conducted Class B EC7A -48S33



# EC7A 10W Isolated DC-DC Converters

## Application Note V10 April 2010

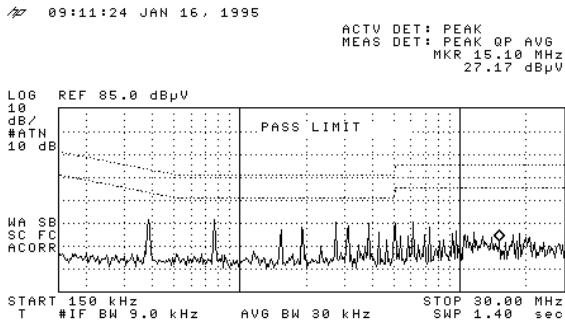

Conducted Class B of EC7A-48S05

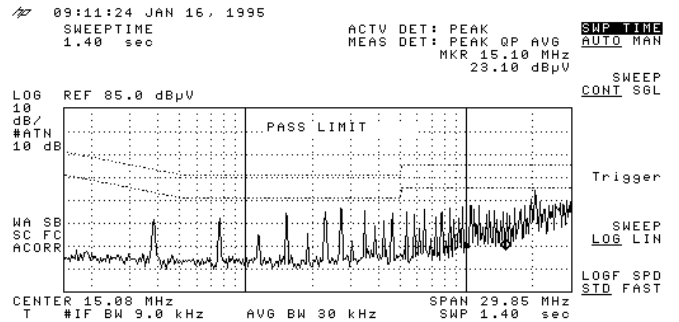

Conducted Class B EC7A -48S12

TBD  
Conducted Class B EC7A -48S15

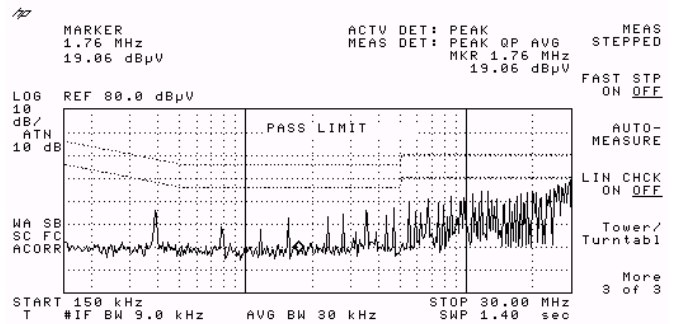

Conducted Class B of EC7A -48D12

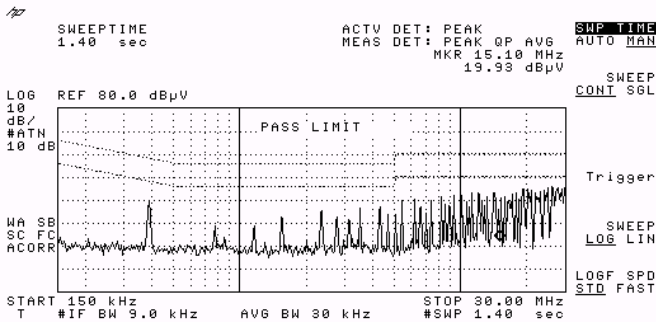

Conducted Class B EC7A -48D15



# EC7A 10W Isolated DC-DC Converters

## Application Note V10 April 2010

### 8. Part Number

**EC7A – XX S XX S**

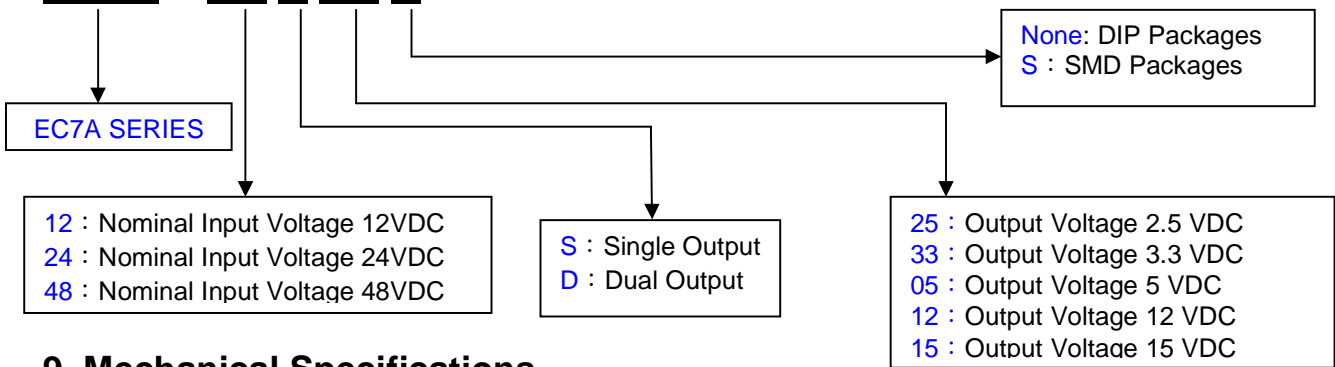

### 9. Mechanical Specifications

NOTE: Pin Size is 0.02" Inch (0.5mm) DIA  
 All Dimensions In Inches (mm)  
 Tolerances Inches: X.XX= ±0.02 , X.XXX= ±0.010  
 Millimeters: X.X= ±0.5 , X.XX=±0.25

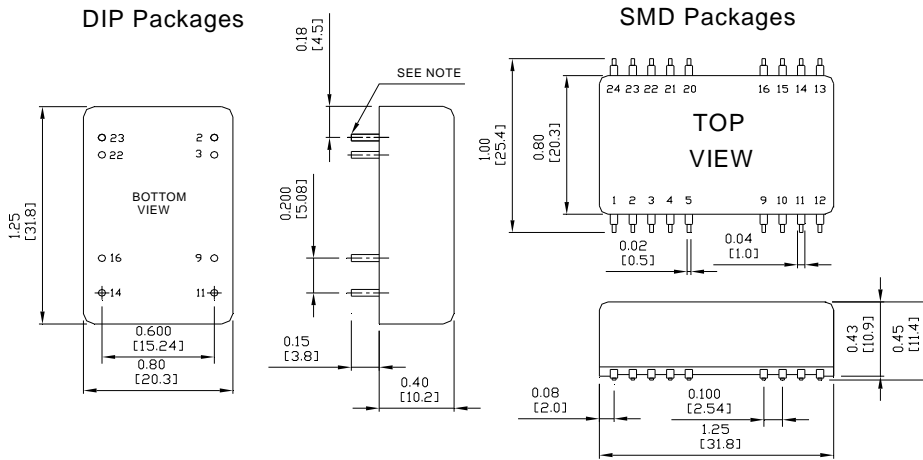

PIN CONNECTION				
Pin	Single Output		Dual Output	
	DIP	SMD	DIP	SMD
1,24	NP	NC	NP	NC
2,3	-V Input		-V Input	
4,5	NP	NC	NP	NC
9	NP	NC	Common	
10	NP	NC	NP	NC
11	NC		-V Output	
12	NP	NC	NP	NC
13	NP	+V Output	NP	NC
14	+V Output		+V Output	
15	NP	-V Output	NP	NC
16	-V Output		Common	
20,21	NP	NC	NP	NC
22,23	+V Input		+V Input	

\* NC-NO CONNECTION WITH PIN  
 \* NP-NO PIN

## CINCON ELECTRONICS CO., LTD.

#### Headquarter Office:

14F, No.306, Sec.4, Hsin Yi Rd.,  
 Taipei, Taiwan  
 Tel: 886-2-27086210  
 Fax: 886-2-27029852  
 E-mail: [sales@cincon.com.tw](mailto:sales@cincon.com.tw)  
 Web Site: <http://www.cincon.com>

#### Factory:

No. 8-1, Fu Kong Rd.,  
 Fu Hsing Industrial Park  
 Fu Hsing Hsiang, ChangHua Hsien,  
 Taiwan  
 Tel: 886-4-7690261  
 Fax: 886-4-7698031

#### Cincon American Office:

1655 Mesa Verde Ave, Ste 180,  
 Ventura, CA 93003  
 Tel: 805-639-3350  
 Fax: 805-639-4101  
 E-mail: [info@cincon.com](mailto:info@cincon.com)