



EC5DAW Series Application Note V10

ISOLATED DC-DC CONVERTER EC5DAW SERIES APPLICATION NOTE



Approved By:

Department	Approved By	Checked By	Written By
Research and Development Department	Jacky	Danny/Zhu Hai	Fei
Design Quality Department	Benny	JoJo	



EC5DAW Series Application Note V10

Contents

1. Introduction	3
2. Pin Function Description	3
3. Connection for Standard Use	4
4. Test Set-Up	4
5. Recommend Layout, PCB Footprint and Soldering Information	4
6. Features and Functions	5
6.1 UVLO (<i>Under Voltage Lock Out</i>)	5
6.2 <i>Over Current/Short Circuit Protection</i>	5
6.3 <i>Remote On/Off</i>	6
7. Input / Output Considerations	6
7.1 <i>Input Capacitance at the Power Module</i>	6
7.2 <i>Output Ripple and Noise</i>	6
7.3 <i>Output Capacitance</i>	7
8. Thermal Design	8
8.1 <i>Operating Temperature Range</i>	8
8.2 <i>Convection Requirements for Cooling</i>	8
8.3 <i>Thermal Considerations</i>	8
8.4 <i>Power Derating</i>	8
9. Safety & EMC	9
9.1 <i>Input Fusing and Safety Considerations</i>	9
9.2 <i>EMC Considerations</i>	9



EC5DAW Series Application Note V10

1. Introduction

The EC5DAW series of DC-DC converters offers 10 watts of output power @ output voltages of 3.3, 5, 12, 15, ± 12 , ± 15 VDC with industry 0.95"x0.54"x0.39" package. It has a wide (4:1) input voltage range of 9 to 36VDC (24VDC nominal), 18 to 74VDC (48VDC nominal) and 3000VDC isolation.

High efficiency up to 89%, allowing case operating temperature range of -40°C to 85°C . Very low no load power consumption (7mA), an ideal solution for energy critical systems.

Fully protected against input UVLO (under voltage lock out), output over-current, continuous short circuit conditions.

The standard control functions include remote on/off (negative).

2. Pin Function Description

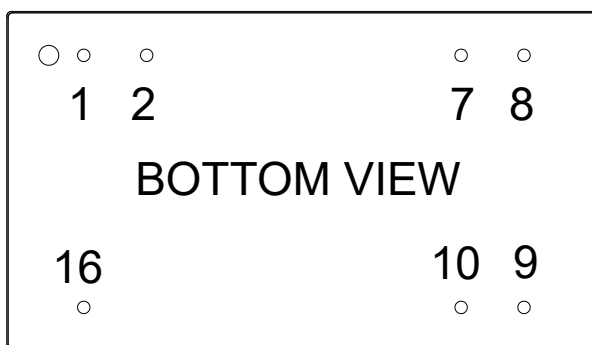

Single Output

No	Label	Function	Description	Reference
1	●	-V Input	Negative Supply Input	Section 7.1
2		Remote On/Off	External Remote On/Off Control	Section 6.3
7		NC	No Connection with Pin	--
8		NC	No Connection with Pin	--
9		+V Output	Positive Power Output	Section 7.2/7.3
10		-V Output	Negative Power Output	Section 7.2/7.3
16		+V Input	Positive Supply Input	Section 7.1

Dual Output

No	Label	Function	Description	Reference
1	●	-V Input	Negative Supply Input	Section 7.1
2		Remote On/Off	External Remote On/Off Control	Section 6.3
7		NC	No Connection with Pin	--
8		Common	Common Power Output	Section 7.2/7.3
9		+V Output	Positive Power Output	Section 7.2/7.3
10		-V Output	Negative Power Output	Section 7.2/7.3
16		+V Input	Positive Supply Input	Section 7.1



EC5DAW Series Application Note V10

3. Connection for Standard Use

The connection for standard use is shown below. External output capacitors (C1, C2) are recommended to reduce output ripple and noise, 1uF ceramic capacitor for all models.

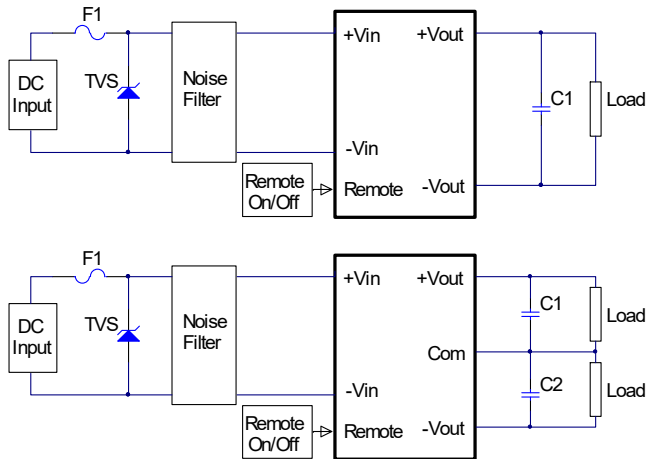

Symbol	Component	Reference
F1, TVS	Input fuse, TVS	Section 9.1
C1, C2	External capacitor on the output side	Section 7.3
Noise Filter	External input noise filter	Section 9.2
Remote On/Off	External remote on/off control	Section 6.3

4. Test Set-Up

The basic test set-up to measure parameters such as efficiency and load regulation is shown below. When testing the modules under any transient conditions please ensure that the transient response of the source is sufficient to power the equipment under test. We can calculate:

- Efficiency
- Load regulation and line regulation

The value of efficiency is defined as:

$$\eta = \frac{V_o \times I_o}{V_{in} \times I_{in}} \times 100\%$$

Where:

- V_o is output voltage
- I_o is output current
- V_{in} is input voltage
- I_{in} is input current

The value of load regulation is defined as:

$$Load\ reg. = \frac{V_{FL} - V_{NL}}{V_{NL}} \times 100\%$$

Where:

- V_{FL} is the output voltage at full load
- V_{NL} is the output voltage at no load

The value of line regulation is defined as:

$$Line\ reg. = \frac{V_{HL} - V_{LL}}{V_{LL}} \times 100\%$$

Where:

- V_{HL} is the output voltage of maximum input voltage at full load
- V_{LL} is the output voltage of minimum input voltage at full load

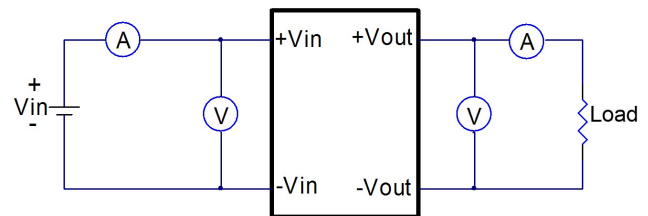

EC5DAW Series Test Setup

5. Recommend Layout, PCB Footprint and Soldering Information

The system designer or end user must ensure that metal and other components in the vicinity of the converter meet the spacing requirements for which the system is approved. Low resistance and inductance PCB layout traces are the norm and should be used where possible. Due consideration must also be given to proper low impedance tracks between power module, input and output grounds. The recommended footprints and soldering profiles are shown below.



EC5DAW Series Application Note V10

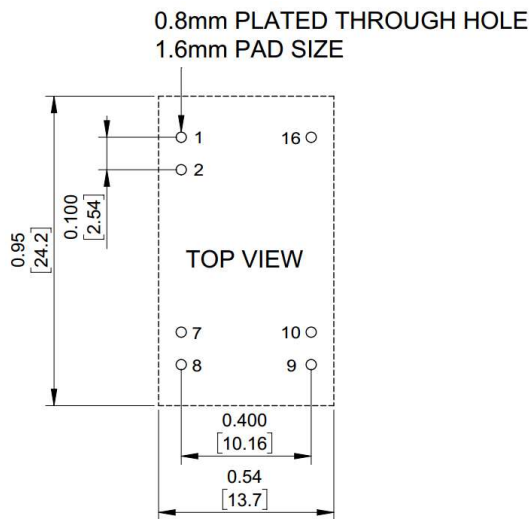

Note: Dimensions are in inches (millimeters)

Clean the soldered side of the module with a brush, prevent liquid from getting into the module. Do not clean by soaking the module into liquid. Do not allow solvent to come in contact with product labels or resin case as this may change the color of the resin case or cause deletion of the letters printed on the product label. After cleaning, dry the modules well.

The suggested soldering iron is $420 \pm 10^\circ\text{C}$ for up to 4-10 seconds (less than 90W) used in double PCB and multilayer PCB, The other one is used in the single PCB is $385 \pm 10^\circ\text{C}$ for up to 2-6 seconds (less than 90W). Furthermore the recommended soldering profile is shown below.

Lead Free Wave Soldering Profile

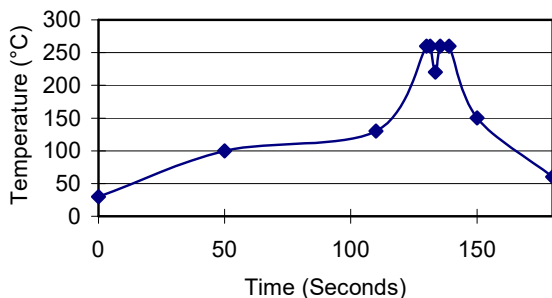

6. Features and Functions

6.1 UVLO (Under Voltage Lock Out)

Input under voltage lockout is standard on the EC5DAW series unit. The unit will shut down when the input voltage drops below a lower threshold, and the unit will operate when the input voltage goes above the upper threshold.

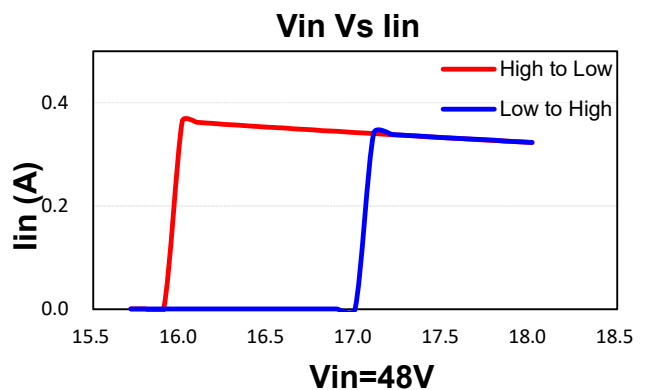
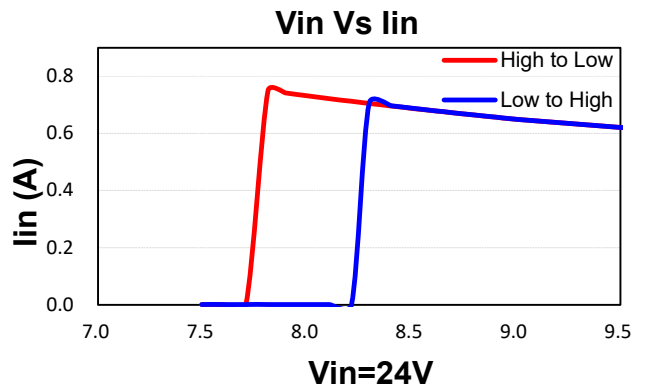

6.2 Over Current/Short Circuit Protection

All models have internal over current and continuous short circuit protection. The unit operates normally once the fault condition is removed. At the point of current limit inception, the converter will go into hiccup mode protection.

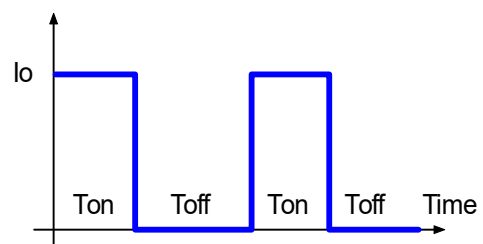
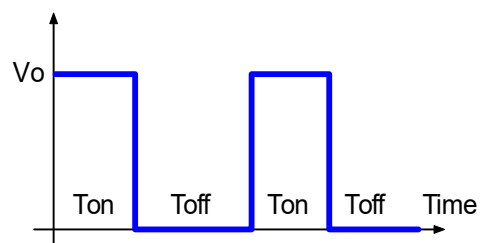



EC5DAW Series Application Note V10

6.3 Remote On/Off

The remote on/off input feature of the converter allows external circuitry to turn the converter on or off. Active-high remote on/off is available as standard. The converter is turned on if the remote on/off pin is open circuit. Supplying the on/off pin at 2mA to 4mA will turn the converter off. The signal level of the on/off pin is defined with respect to ground. If not using the on/off pin, leave the pin open (module will be on), recommended application circuit refer figure.

On/Off pin applied current via 1K

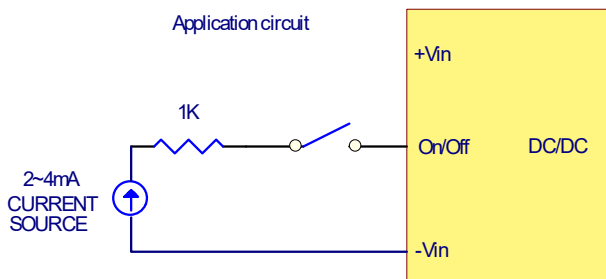

7. Input / Output Considerations

7.1 Input Capacitance at the Power Module

The converters must be connected to low AC source impedance. To avoid problems with loop stability source inductance should be low. Also, the input capacitors (Cin) should be placed close to the converter input pins to decouple distribution inductance. However, the external input capacitors are chosen for suitable ripple handling capability. Low ESR capacitors are good choice. Circuit as shown as below represents typical measurement methods for reflected ripple current. C1 and L1 simulate a typical DC source impedance. The input reflected-ripple current is measured by current probe to oscilloscope with a simulated source inductance (L1).

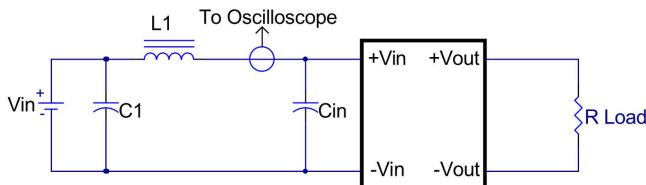

- L1: 12uH
- C1: None
- Cin: 47uF ESR<0.17ohm @100KHz

7.2 Output Ripple and Noise

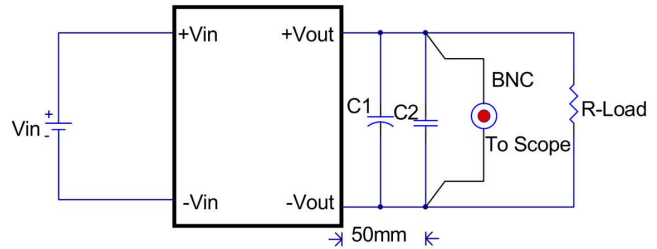

Note:

- C1: None
- C2: 1uF ceramic capacitor.

EC5DAW single output module

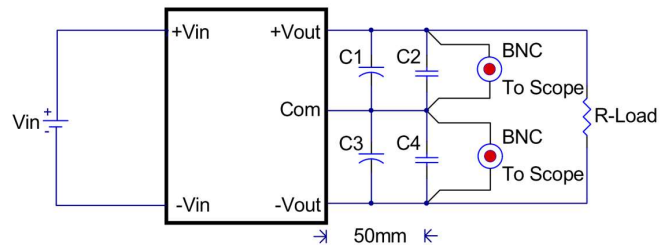

Note:

- C1 & C3: None, C2 & C4: 1uF ceramic capacitor.

EC5DAW dual output module

Output ripple and noise measured with 1uF ceramic capacitor across output, a 20 MHz bandwidth oscilloscope is normally used for the measurement.

The conventional ground clip on an oscilloscope probe should never be used in this kind of measurement. This clip, when placed in a field of radiated high frequency energy, acts as an antenna or inductive pickup loop, creating an extraneous voltage that is not part of the output noise of the converter.

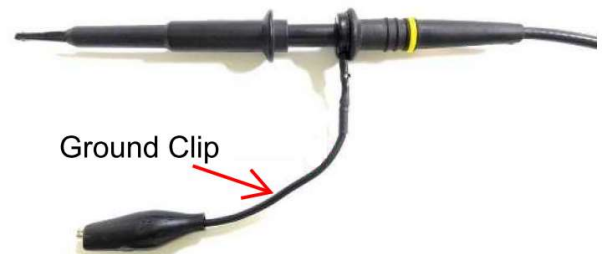



EC5DAW Series Application Note V10

Another method is shown in below, in case of coaxial-cable/BNC is not available. The noise pickup is eliminated by pressing scope probe ground ring directly against the -Vout terminal while the tip contacts the +Vout terminal. This makes the shortest possible connection across the output terminals.

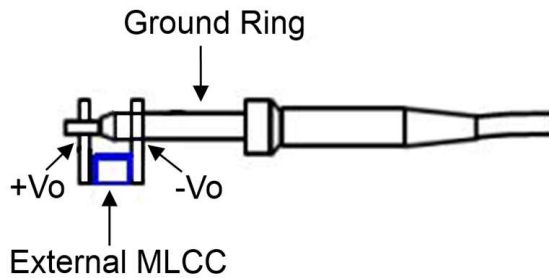

7.3 Output Capacitance

The EC5DAW series converters provide unconditional stability with or without external capacitors. For good transient response, low ESR output capacitors should be located close to the point of load (<100mm). PCB design emphasizes low resistance and inductance tracks in consideration of high current applications. Output capacitors with their associated ESR values have an impact on loop stability and bandwidth. Cincon's converters are designed to work with load capacitance to see technical specifications.



EC5DAW Series Application Note V10

8. Thermal Design

8.1 Operating Temperature Range

The EC5DAW series converters can be operated within a wide ambient temperature range of -40°C to 85°C. Consideration must be given to the derating curves when ascertaining maximum power that can be drawn from the converter. The maximum power drawn from models is influenced by usual factors, such as:

- Input voltage range
- Output load current
- Forced air or natural convection

8.2 Convection Requirements for Cooling

To predict the approximate cooling needed for the 0.95"×0.54" module, refer to the power derating curves in **datasheet**. These derating curves are approximations of the ambient temperatures and airflows required to keep the power module temperature below its maximum rating. Once the module is assembled in the actual system, the module's temperature should be monitored to ensure it does not exceed 105°C as measured at the center of the top of the case (thus verifying proper cooling).

8.3 Thermal Considerations

The power module operates in a variety of thermal environments; however, sufficient cooling should be provided to help ensure reliable operation of the unit. Heat is removed by conduction, convection, and radiation to the surrounding environment. The example is presented in **datasheet**. The power output of the module should not be allowed to exceed rated power ($V_{o_set} \times I_{o_max}$).

8.4 Power Derating

The operating ambient temperature range of EC5DAW series is -40°C to +85°C. When operating the EC5DAW series, proper derating or cooling is needed. The maximum case temperature under any operating condition should not exceed 105°C (refer to datasheet).



EC5DAW Series Application Note V10

9. Safety & EMC

9.1 Input Fusing and Safety Considerations

The EC5DAW series converters have not an internal fuse. However, to achieve maximum safety and system protection, always use an input line fuse. We recommended a fast acting fuse 2A for 24Vin models and 1A for 48Vin modules. Figure 9 circuit is recommended by a Transient Voltage Suppressor diode across the input terminal to protect the unit against surge or spike voltage and input reverse voltage.

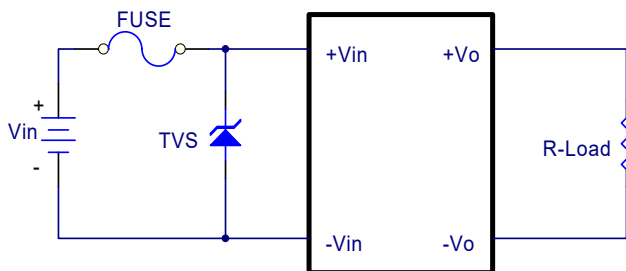

9.2 EMC Considerations

EMI Test standard: EN55032 Conducted & Radiated Emission
 Test Condition: Input Voltage: Nominal, Output Load: Full Load
 (1) EMI meet EN55032

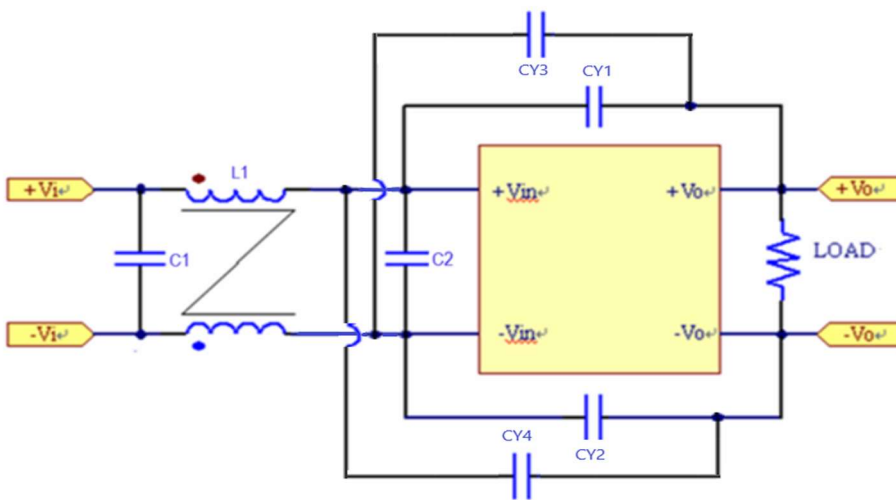

Model Number	Conduction Class A				
	C1	C2	CY1, CY3, CY4	CY2	L1
EC5DAW-24XXX	4.7uF/100V 1812	4.7uF/100V 1812	None	1000pF/4KV 1808	Short
EC5DAW-48XXX					

Note:
 C1, C2 X7R 1812 X7R ceramic capacitor.
 CY2 1808 X7R ceramic capacitor.



EC5DAW Series Application Note V10

Model Number	Radiation Class A			
	C1	C2	CY1, CY2, CY3, CY4	L1
EC5DAW-24XXX	4.7uF/100V 1812*2	4.7uF/100V 1812*2	2200pF/3KV 1808	QF7035301YLB
EC5DAW-48XXX				

Note:

C1, C2 X7R 1812 X7R ceramic capacitor.

CY1,CY2, CY3, CY4 1808 X7R ceramic capacitor.

L1: CMCK SMD QF7035301YLB ABC.

With aluminum plate (17x17x0.04 inch).

Conducted Emission Class A:

EC5DAW-24S33N

Line

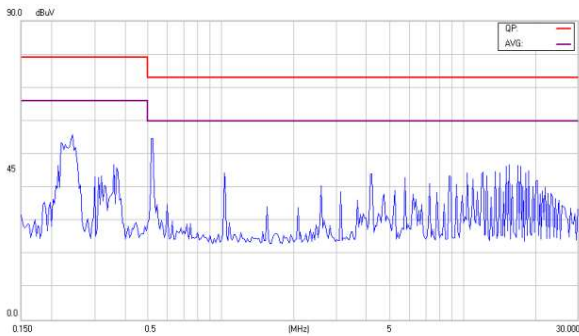

Neutral

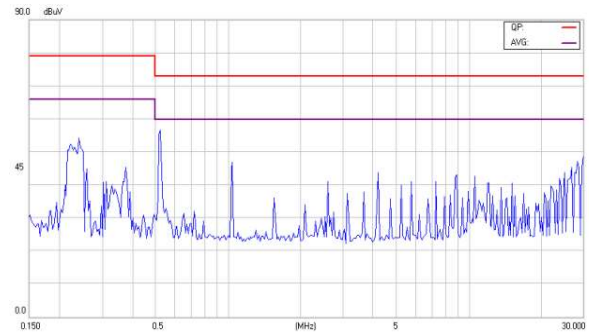

EC5DAW-24S05N

Line

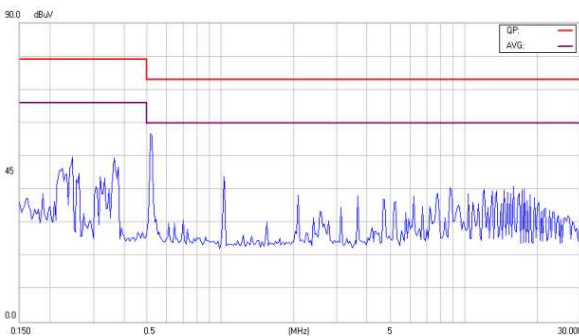

Neutral

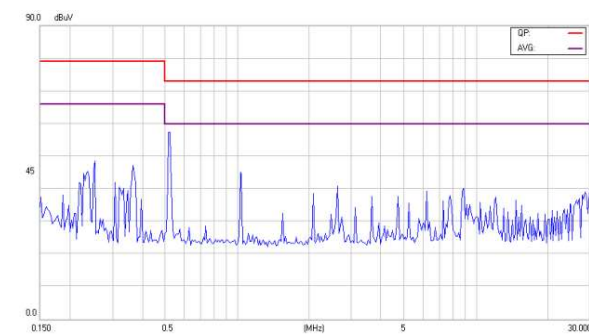



EC5DAW Series Application Note V10

EC5DAW-24S12N

Line

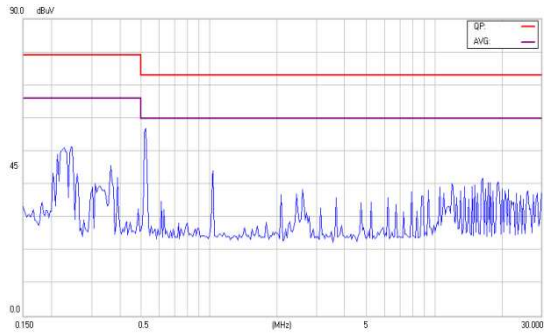

Neutral

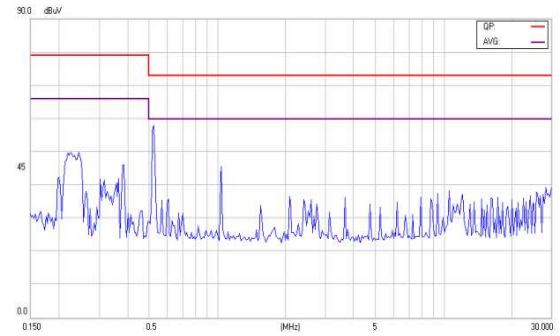

EC5DAW-24S15N

Line

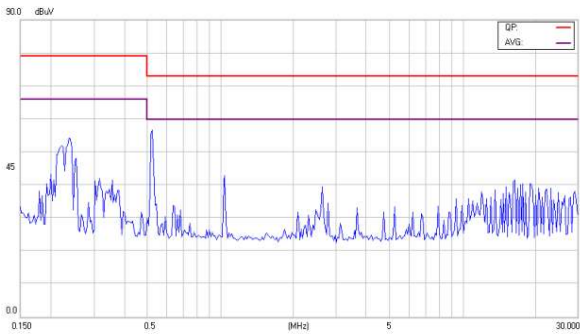

Neutral

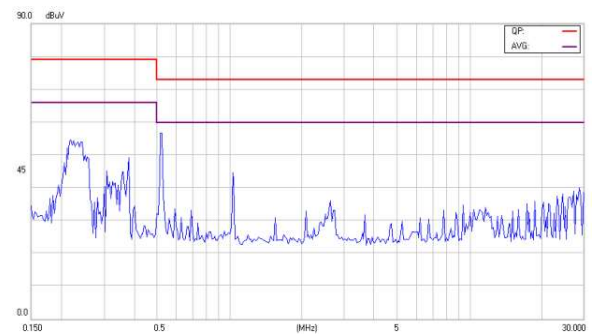

EC5DAW-24D12N

Line

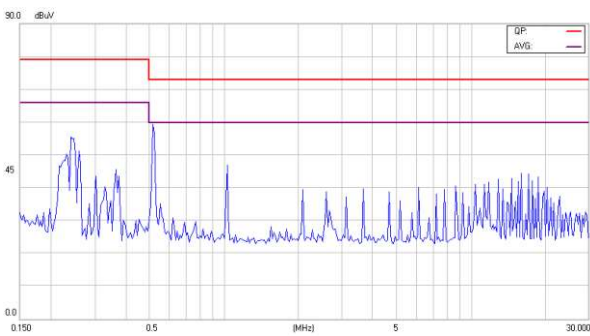

Neutral

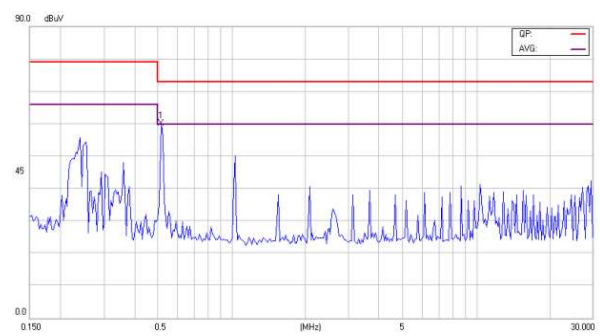

EC5DAW-24D15N

Line

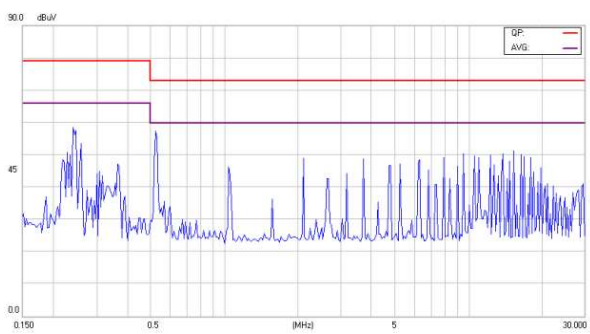

Neutral

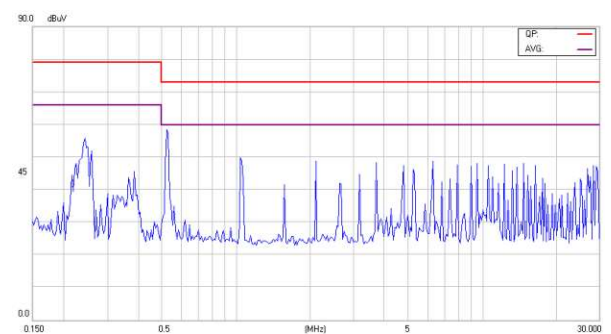



EC5DAW Series Application Note V10

EC5DAW-48S33N

Line

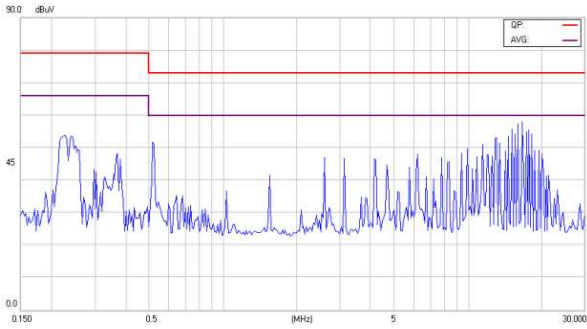

Neutral

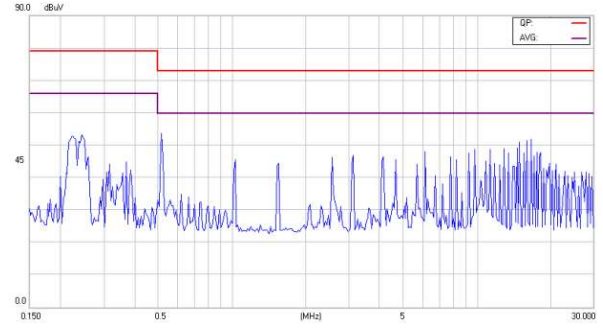

EC5DAW-48S05N

Line

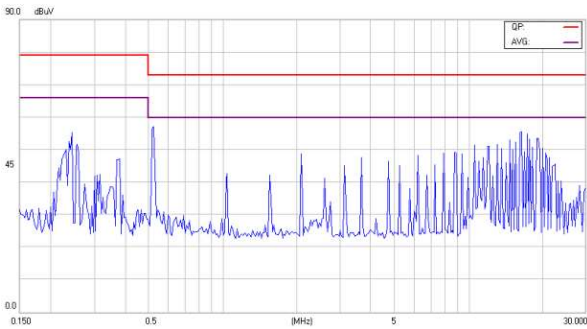

Neutral

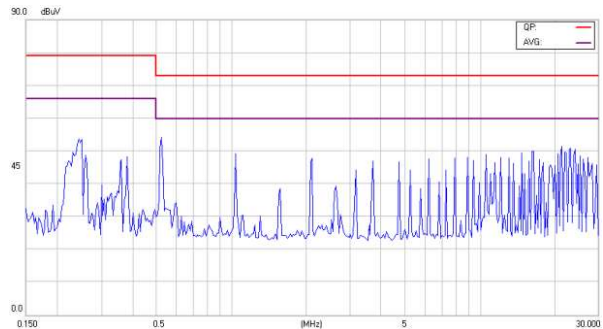

EC5DAW-48S12N

Line

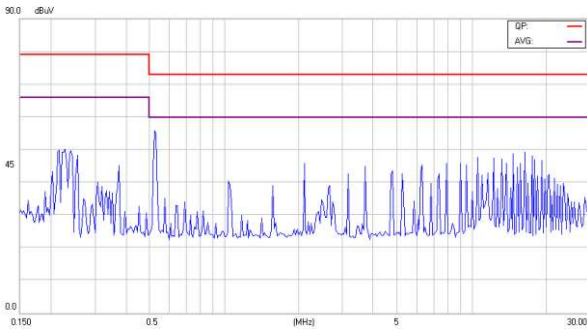

Neutral

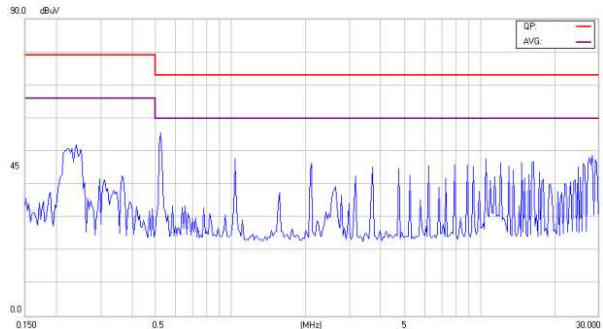

EC5DAW-48S15N

Line

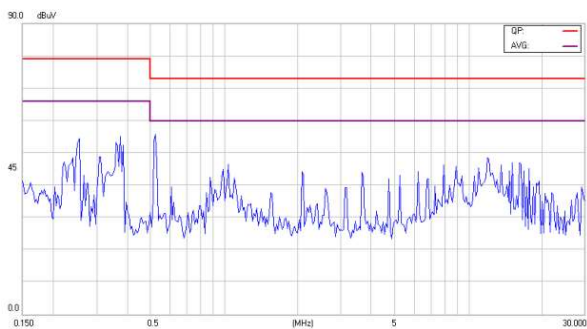

Neutral

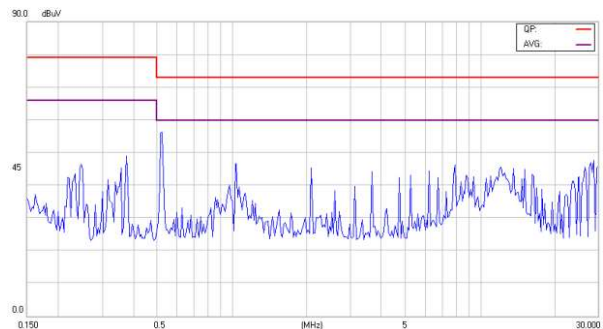



EC5DAW Series Application Note V10

EC5DAW-48D12N

Line

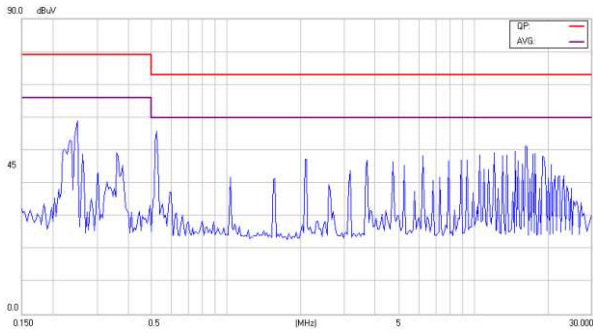

Neutral

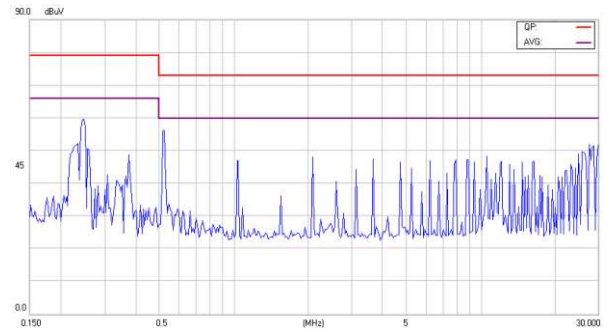

EC5DAW-48D15N

Line

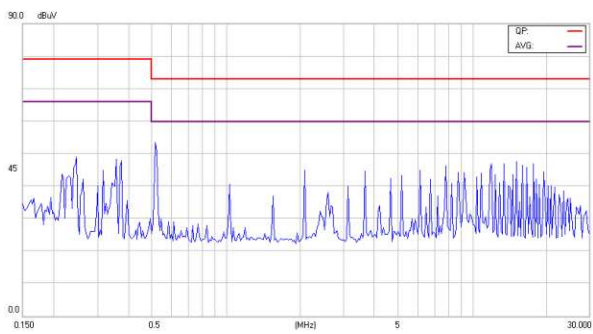

Neutral

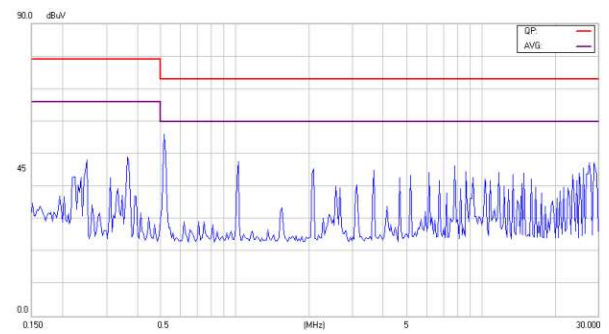

Radiated Emission Class A:

EC5DAW-24S33N

Vertical

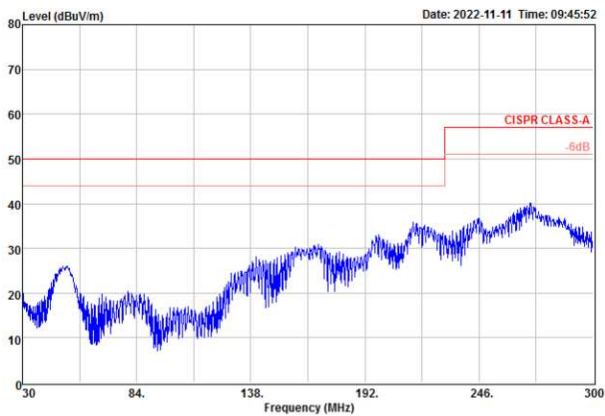

EC5DAW-24S05N

Vertical

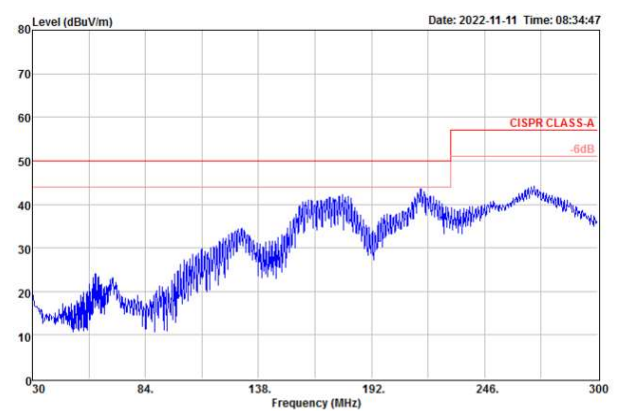



EC5DAW Series Application Note V10

EC5DAW-24S12N

Vertical

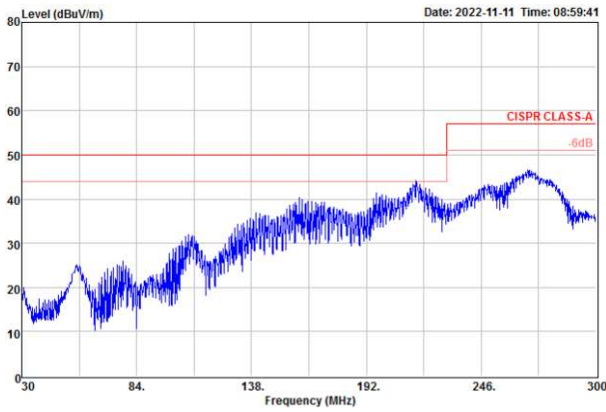

EC5DAW-24S15N

Vertical

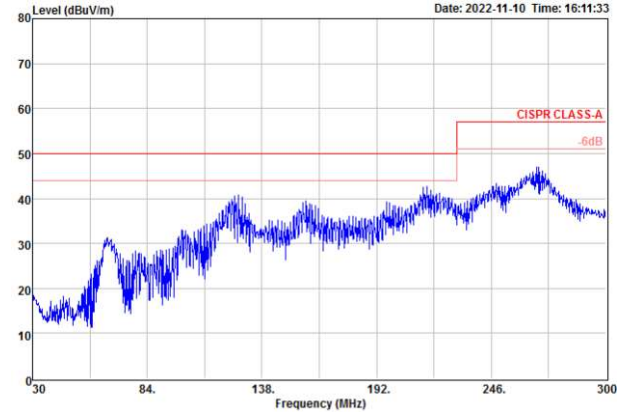

EC5DAW-24D12N

Vertical

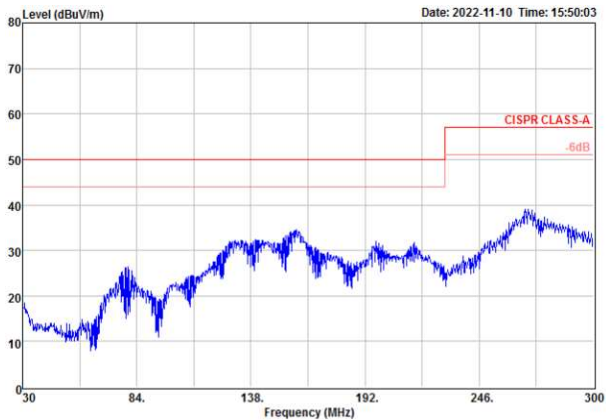

EC5DAW-24D15N

Vertical

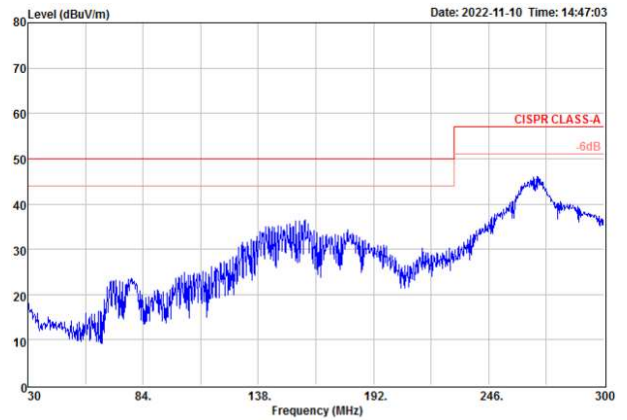

EC5DAW-48S33N

Vertical

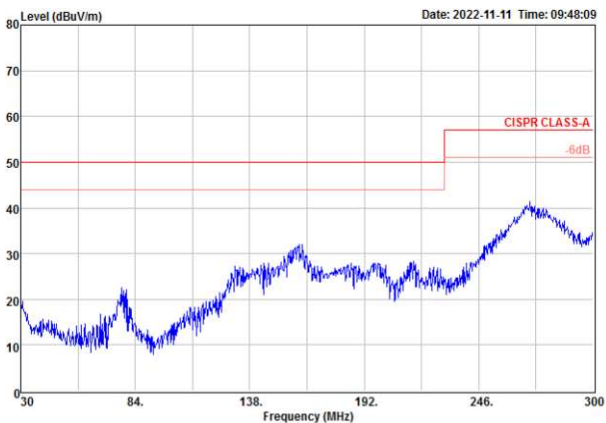

EC5DAW-48S05N

Vertical

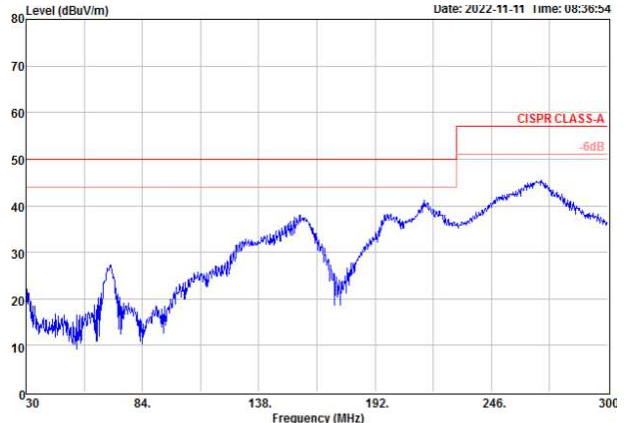



EC5DAW Series Application Note V10

EC5DAW-48S12N

Vertical

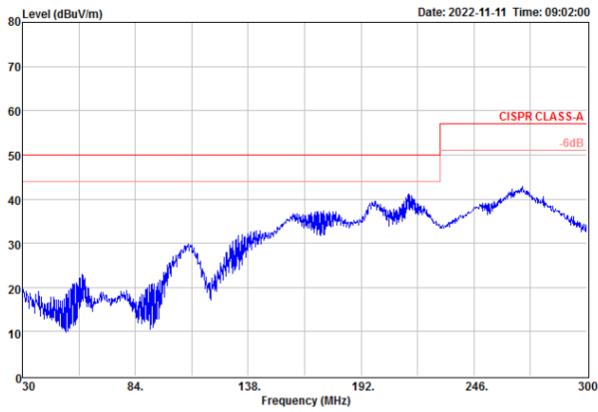

EC5DAW-48S55N

Vertical

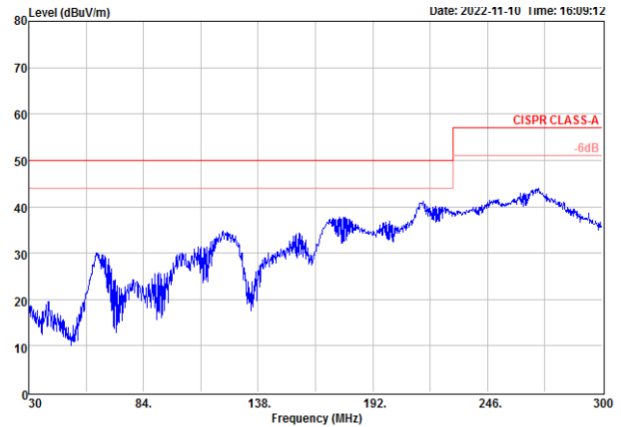

EC5DAW-48D12N

Vertical

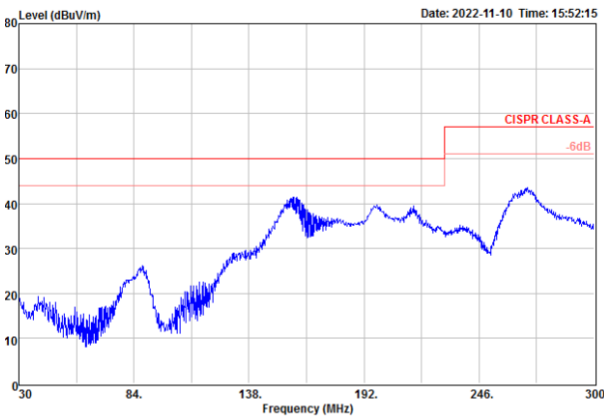

EC5DAW-48D15N

Vertical

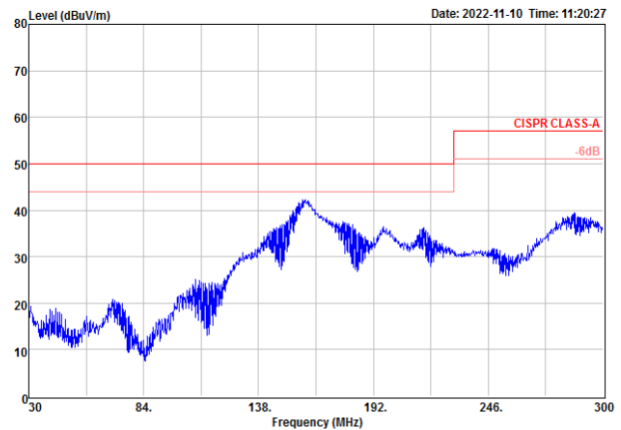

CINCON ELECTRONICS CO., LTD.

Headquarters:

14F, No.306, Sec.4, Hsin Yi Rd.
Taipei, Taiwan
Tel: 886-2-27086210
Fax: 886-2-27029852
E-mail: sales@cincon.com.tw
Web Site: <https://www.cincon.com>

Factory:

No. 8-1, Fu Kung Rd.
Fu Hsing Industrial Park
Fu Hsing Hsiang,
ChangHua Hsien, Taiwan
Tel: 886-4-7690261
Fax: 886-4-7698031

Cincon North America:

1655Mesa Verde Ave. Ste 180
Ventura, CA93003
Tel: 805-639-3350
Fax: 805-639-4101
E-mail: info@cincon.com