



EC3SAWH Series Application Note V10

ISOLATED DC-DC CONVERTER EC3SAWH SERIES APPLICATION NOTE



Approved By:

Department	Approved By	Checked By	Written By
Research and Development Department	Enoch	Danny	Tony
		Jacky	
Design Quality Department	Benny	JoJo	



EC3SAWH Series Application Note V10

Contents

1. Introduction	3
2. Pin Function Description	3
3. Connection for Standard Use	4
4. Test Set-Up	4
5. Recommend Layout, PCB Footprint and Soldering Information	4
6. Features and Functions	5
6.1 Over Current/Short Circuit Protection	5
6.2 Remote On/Off	5
7. Input/Output Considerations	5
7.1 Input Capacitance at the Power Module	5
7.2 Output Ripple and Noise	6
7.3 Output Capacitance	6
8. Thermal Design	7
8.1 Operating Temperature Range	7
8.2 Convection Requirements for Cooling	7
8.3 Thermal Considerations	7
8.4 Power Derating	7
9. Safety & EMC	8
9.1 Input Fusing and Safety Considerations	8
9.2 EMC Considerations	8



EC3SAWH Series Application Note V10

1. Introduction

The EC3SAWH series offer 3 watts of output power in a 0.86x0.36x0.44 inches SIP-8 plastic packages. The EC3SAWH series has a 4:1 wide input voltage range of 9-36 and 18-74VDC and provides a precisely regulated output. This series has features such as high efficiency, 3000VDC of isolation and allows an ambient operating temperature range of -40°C to 85°C with de-rating. The features include short circuit protection and remote on/off control. All models are very suitable for distributed power architectures, telecommunications, battery operated equipment and industrial applications.

2. Pin Function Description

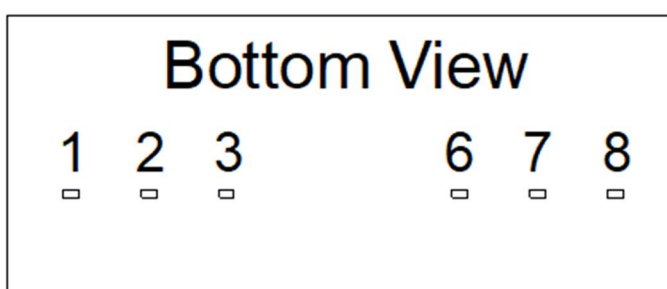

Single Output

No	Label	Function	Description	Reference
1	●	-V Input	Negative Supply Input	Section 7.1
2		+V Input	Positive Supply Input	Section 7.1
3		Remote On/Off	External Remote On/Off Control	Section 6.2
6		+V Output	Positive Power Output	Section 7.2/7.3
7		-V Output	Negative Power Output	Section 7.2/7.3
8		NC	No Connection with Pin	--

Dual Output

No	Label	Function	Description	Reference
1	●	-V Input	Negative Supply Input	Section 7.1
2		+V Input	Positive Supply Input	Section 7.1
3		Remote On/Off	External Remote On/Off Control	Section 6.2
6		+V Output	Positive Power Output	Section 7.2/7.3
7		Common	Common Power Output	Section 7.2/7.3
8		-V Output	Negative Power Output	Section 7.2/7.3



EC3SAWH Series Application Note V10

3. Connection for Standard Use

The connection for standard use is shown below. External output capacitors (C1, C2) are recommended to reduce output ripple and noise, 0.1uF ceramic capacitor for all models.

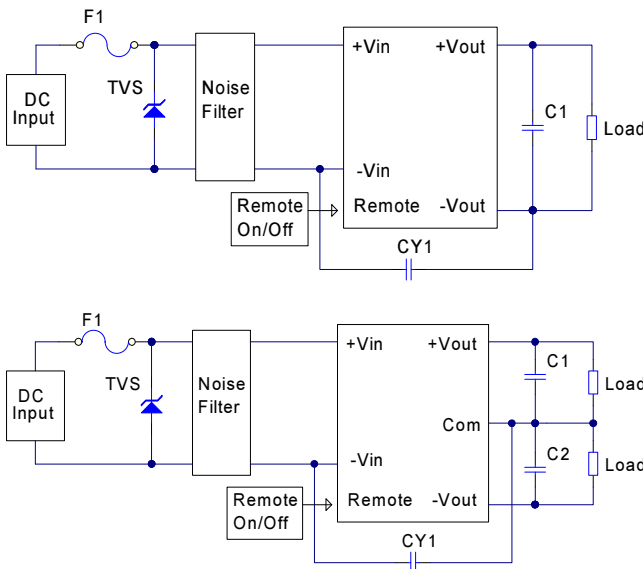

Symbol	Component	Reference
F1, TVS	Input fuse, TVS	Section 9.1
C1, C2, CY1	External capacitor to reduce output ripple and noise	Section 7.2
Noise Filter	External input noise filter	Section 9.2
Remote On/Off	External remote on/off control	Section 6.2

4. Test Set-Up

The basic test set-up to measure parameters such as efficiency and load regulation is shown below. When testing the modules under any transient conditions please ensure that the transient response of the source is sufficient to power the equipment under test. We can calculate:

- Efficiency
- Load regulation and line regulation

The value of efficiency is defined as:

$$\eta = \frac{V_o \times I_o}{V_{in} \times I_{in}} \times 100\%$$

Where:

V_o is output voltage
 I_o is output current
 V_{in} is input voltage
 I_{in} is input current

The value of load regulation is defined as:

$$Load\ reg. = \frac{V_{FL} - V_{NL}}{V_{NL}} \times 100\%$$

Where:

V_{FL} is the output voltage at full load
 V_{NL} is the output voltage at 10% load

The value of line regulation is defined as:

$$Line\ reg. = \frac{V_{HL} - V_{LL}}{V_{LL}} \times 100\%$$

Where:

V_{HL} is the output voltage of maximum input voltage at full load
 V_{LL} is the output voltage of minimum input voltage at full load

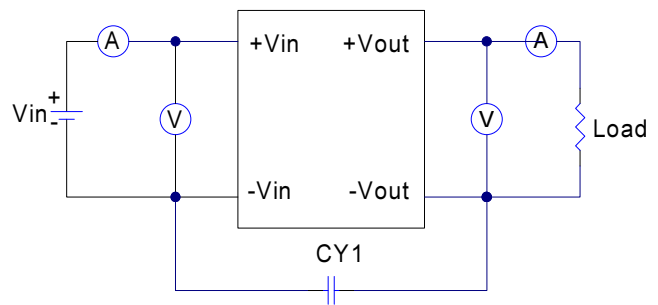

CY1: 470pF/3KV ceramic capacitor

EC3SAWH Series Test Setup

5. Recommend Layout, PCB Footprint and Soldering Information

The system designer or end user must ensure that metal and other components in the vicinity of the converter meet the spacing requirements for which the system is approved. Low resistance and inductance PCB layout traces are the norm and should be used where possible. Due consideration must also be given to proper low impedance tracks between power module, input and output grounds. The recommended footprints and soldering profiles are shown below.

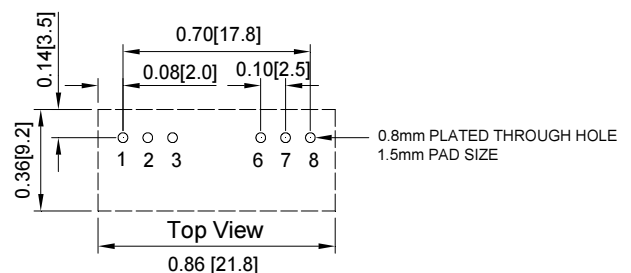

Note: Dimensions are in inches (millimeters)



EC3SAWH Series Application Note V10

Clean the soldered side of the module with a brush, prevent liquid from getting into the module. Do not clean by soaking the module into liquid. Do not allow solvent to come in contact with product labels or resin case as this may change the color of the resin case or cause deletion of the letters printed on the product label. After cleaning, dry the modules well.

The suggested soldering iron is $420 \pm 10^\circ\text{C}$ for up to 4-10 seconds (less than 90W) used in double PCB and multilayer PCB, the other one is $385 \pm 10^\circ\text{C}$ for up to 2-6 seconds (less than 90W) used in the single PCB. Furthermore the recommended soldering profile is shown below.

Lead Free Wave Soldering Profile

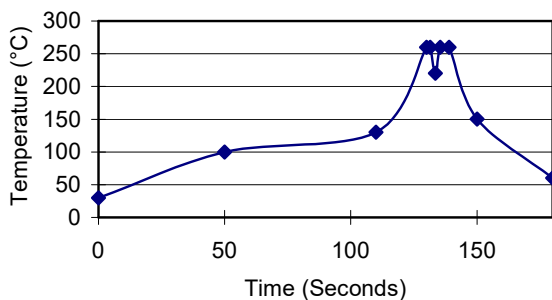

6. Features and Functions

6.1 Over Current/Short Circuit Protection

All models have internal over current and continuous short circuit protection. The unit operates normally once the fault condition is removed. At the point of current limit inception, the converter will go into foldback mode protection.

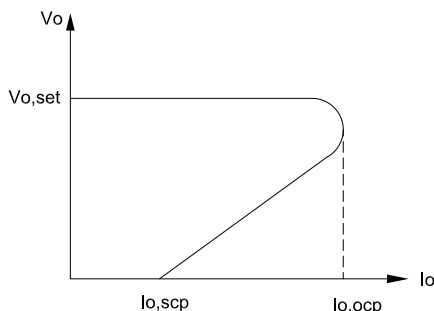

$V_{o,set}$: rated output voltage
 $I_{o,ocp}$: output current at the point of current limit inception
 $I_{o,scp}$: output current when the load is short-circuited

6.2 Remote On/Off

The remote ON/OFF input feature of the converter allows external circuitry to turn the converter ON or OFF. Active-high remote ON/OFF is available as standard. The converter is turned on if the remote ON/OFF pin is open circuit. Supplying the on/off pin at 0 to 1.2Vdc will turn the converter off. The signal level of the on/off pin is defined with respect to ground. If not using the on/off pin, leave the pin open (module will be on).

Logic State (Pin 3)	Positive Logic
Logic High (Open or high impedance)	Module on
Logic Low	Module off

Connection examples see below.

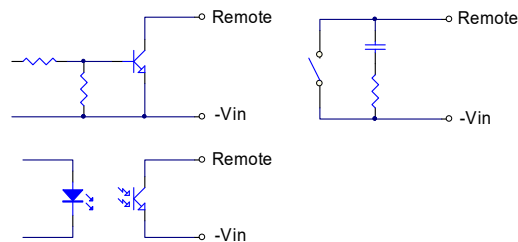

Remote On/Off Connection Examples

7. Input/Output Considerations

7.1 Input Capacitance at the Power Module

The converters must be connected to low AC source impedance. To avoid problems with loop stability source inductance should be low. Also, the input capacitors (C_{in}) should be placed close to the converter input pins to decouple distribution inductance. However, the external input capacitors are chosen for suitable ripple handling capability. Low ESR capacitors are good choice. Circuit as shown as below represents typical measurement methods for reflected ripple current. C_1 and L_1 simulate a typical DC source impedance. The input reflected-ripple current is measured by current probe to oscilloscope with a simulated source inductance (L_1).

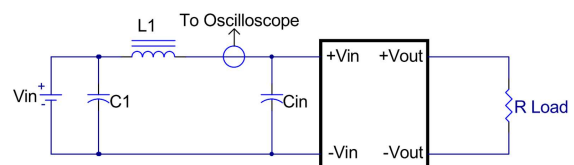

L_1 : 12uH
 C_1 : None
 C_{in} : 33uF ESR<0.17ohm @100KHz



EC3SAWH Series Application Note V10

7.2 Output Ripple and Noise

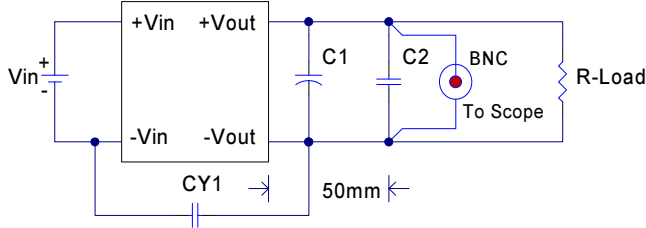

Note: C1: None, C2: 0.1uF ceramic capacitor,
CY1: 470pF/3KV ceramic capacitor.

EC3SAWH Single Output Module

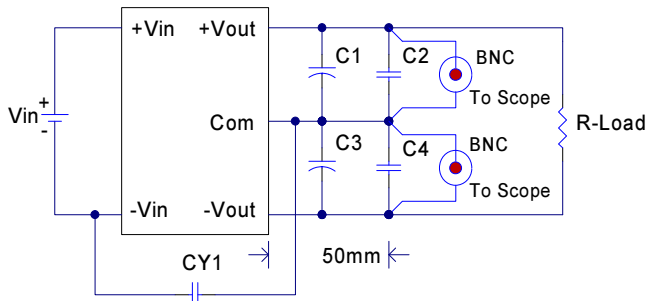

Note: C1 & C3: None, C2 & C4: 0.1uF ceramic capacitor,
CY1: 470pF/3KV ceramic capacitor.

EC3SAWH Dual Output Module

Output ripple and noise measured with 470pF ceramic capacitor across input/output, A 20 MHz bandwidth oscilloscope is normally used for the measurement.

The conventional ground clip on an oscilloscope probe should never be used in this kind of measurement. This clip, when placed in a field of radiated high frequency energy, acts as an antenna or inductive pickup loop, creating an extraneous voltage that is not part of the output noise of the converter.

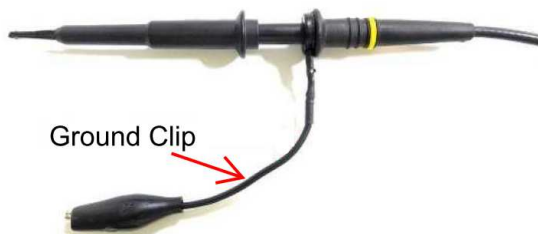

Another method is shown in below, in case of coaxial-cable/BNC is not available. The noise pickup is eliminated by pressing scope probe ground ring directly against the -Vout terminal while the tip contacts the +Vout terminal. This makes the shortest possible connection across the output terminals.

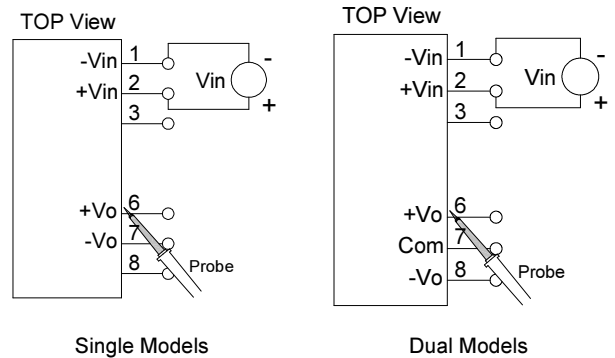

Using Probe to Measure Output Ripple and Noise

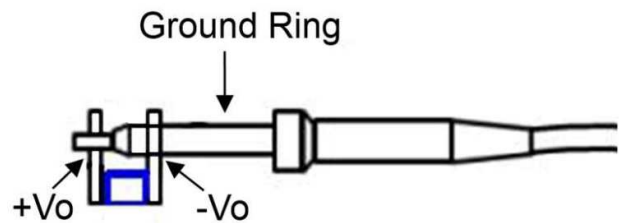

7.3 Output Capacitance

The EC3SAWH series converters provide unconditional stability with or without external capacitors. For good transient response, low ESR output capacitors should be located close to the point of load (<100mm). PCB design emphasizes low resistance and inductance tracks in consideration of high current applications. Output capacitors with their associated ESR values have an impact on loop stability and bandwidth. Cincon's converters are designed to work with load capacitance to see technical specifications.



EC3SAWH Series Application Note V10

8. Thermal Design

8.1 Operating Temperature Range

The EC3SAWH series converters can be operated within a wide case temperature range of -40°C to 85°C . Consideration must be given to the derating curves when ascertaining maximum power that can be drawn from the converter. The maximum power drawn from models is influenced by usual factors, such as:

- Input voltage range
- Output load current
- Forced air or natural convection

8.2 Convection Requirements for Cooling

To predict the approximate cooling needed for the 0.86"×0.36" module, refer to the power derating curves in **datasheet**. These derating curves are approximations of the ambient temperatures and airflows required to keep the power module temperature below its maximum rating. Once the module is assembled in the actual system, the module's temperature should be monitored to ensure it does not exceed 100°C as measured at the center of the top of the case (thus verifying proper cooling).

8.3 Thermal Considerations

The power module operates in a variety of thermal environments; however, sufficient cooling should be provided to help ensure reliable operation of the unit. Heat is removed by conduction, convection, and radiation to the surrounding environment. The example is presented in **datasheet**. The power output of the module should not be allowed to exceed rated power ($V_{o_set} \times I_{o_max}$).

8.4 Power Derating

The operating case temperature range of EC3SAWH series is -40°C to $+85^{\circ}\text{C}$. When operating the EC3SAWH series, proper derating or cooling is needed. The maximum case temperature under any operating condition should not exceed 100°C (refer to **datasheet**).



EC3SAWH Series Application Note V10

9. Safety & EMC

9.1 Input Fusing and Safety Considerations

The EC3SAWH series converters have no internal fuse. In order to achieve maximum safety and system protection, always use an input line fuse. We recommended a fast acting fuse 1A for 24Vin models and 500mA for 48Vin modules. It is recommended that the circuit have a transient voltage suppressor diode (TVS) across the input terminal to protect the unit against surge or spike voltage and input reverse voltage (as shown).

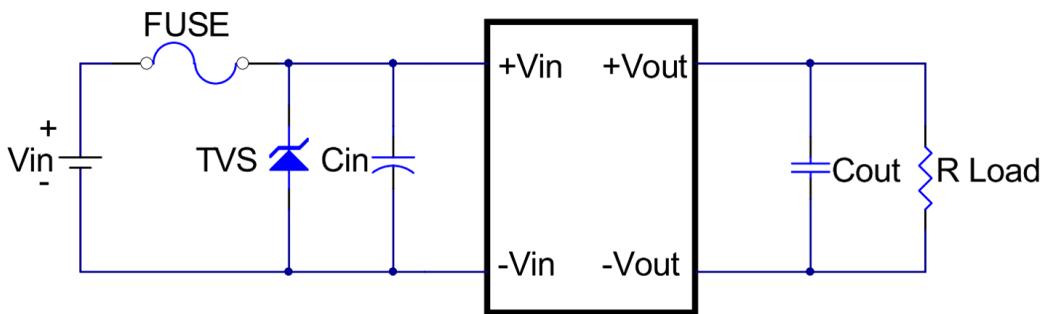

The external TVS is required if EC3SAWH series has to meet EN61000-4-4 & EN61000-4-5

9.2 EMC Considerations

EMI Test standard: EN55032 Conducted Emission

Test Condition: Input Voltage: Nominal, Output Load: Full Load

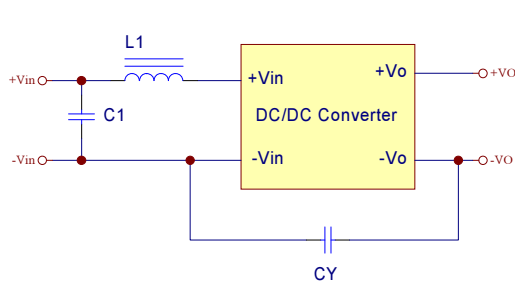

EC3SAWH single output module

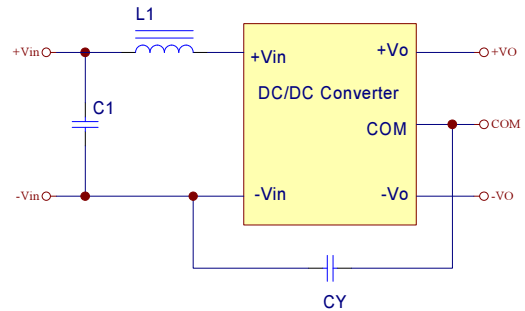

EC3SAWH dual output module

Model Number		C1	CY	L1
Class A	EC3SAW-24xxxHP	2.2uF/50V	470pF	10uH
	EC3SAW-48xxxHP	2.2uF/100V	470pF	15uH
Class B	EC3SAW-24xxxHP	2.2uF/50V	1000pF	15uH
	EC3SAW-48xxxHP	2.2uF/100V	1000pF	56uH

Note:

C1: 1210 X7R ceramic capacitor.

CY: TDK Y1 capacitor.

L1: 10uH, P/N: SR0805100MLB, ABC

15uH, P/N: SR0805150MLB, ABC

56uH, P/N: SMTDR105-560M-SK5Z0, 3L



EC3SAWH Series Application Note V10

Vin = 24Vdc

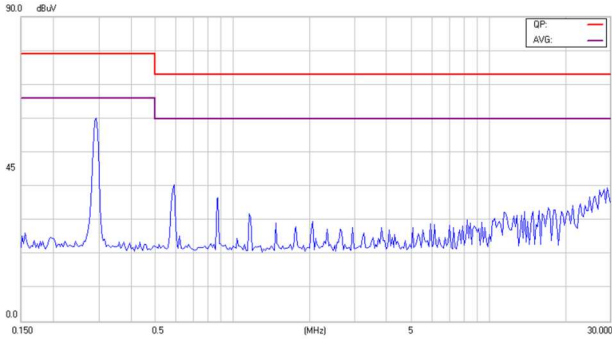

Conducted Class A of EC3SAW-24S33HP

Vin = 24Vdc

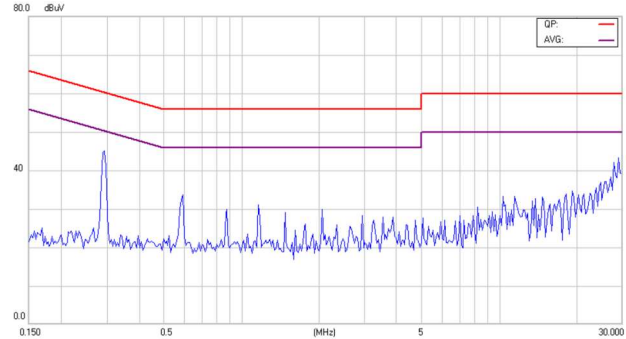

Conducted Class B of EC3SAW-24S33HP

Vin = 24Vdc

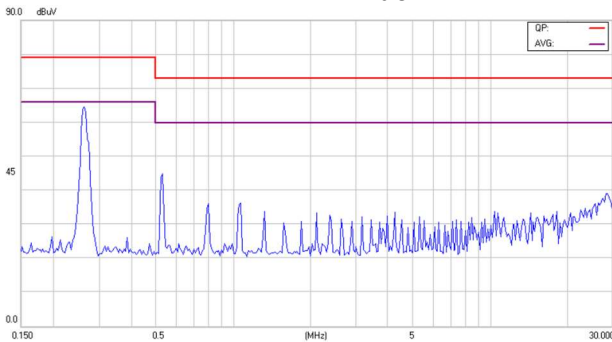

Conducted Class A of EC3SAW-24S05HP

Vin = 24Vdc

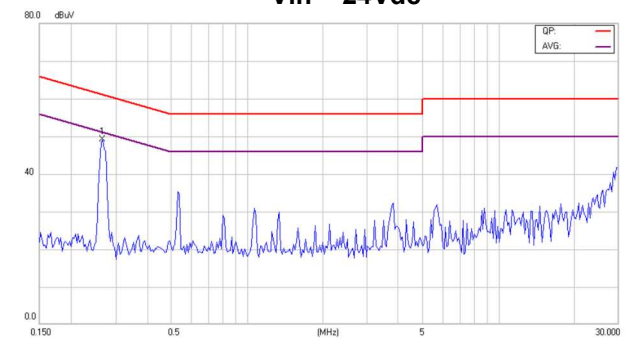

Conducted Class B of EC3SAW-24S05HP

Vin = 24Vdc

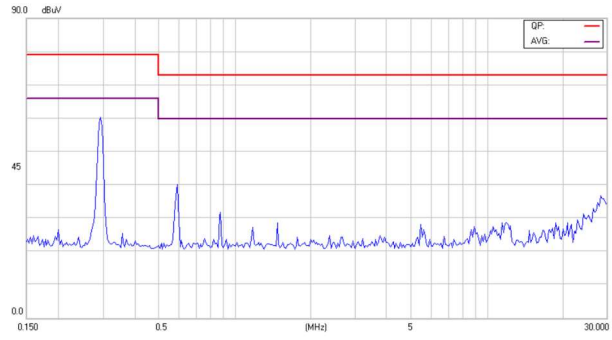

Conducted Class A of EC3SAW-24S12HP

Vin = 24Vdc

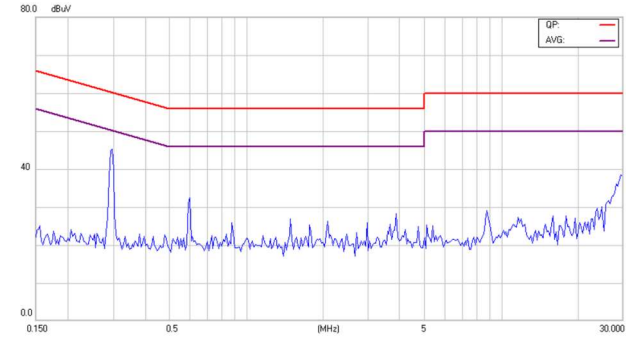

Conducted Class B of EC3SAW-24S12HP

Vin = 24Vdc

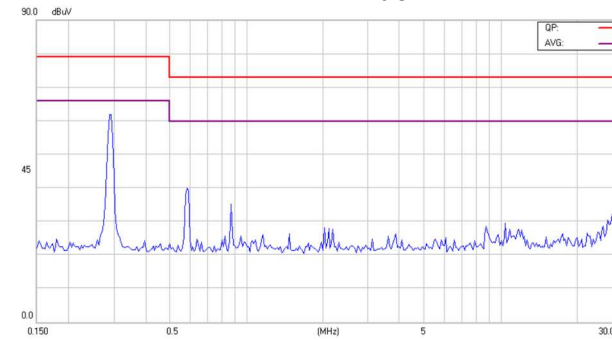

Conducted Class A of EC3SAW-24S15HP

Vin = 24Vdc

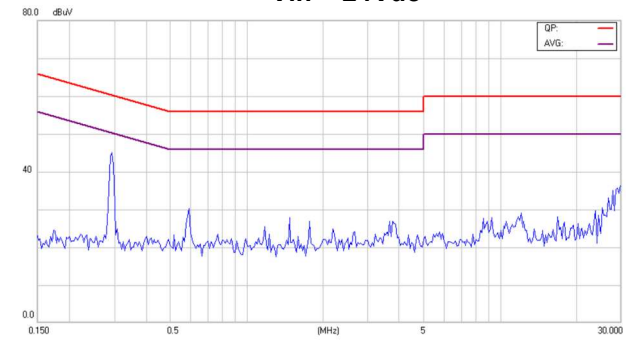

Conducted Class B of EC3SAW-24S15HP



EC3SAWH Series Application Note V10

Vin = 24Vdc

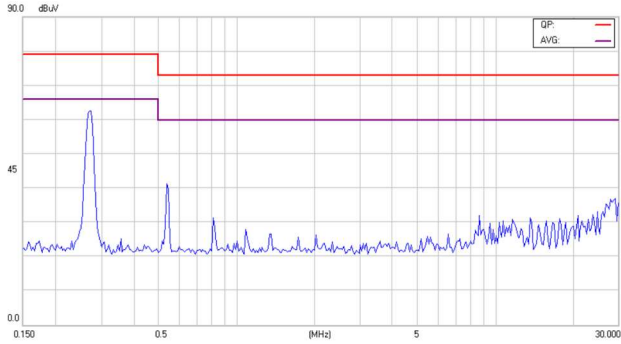

Conducted Class A of EC3SAW-24D05HP

Vin = 24Vdc

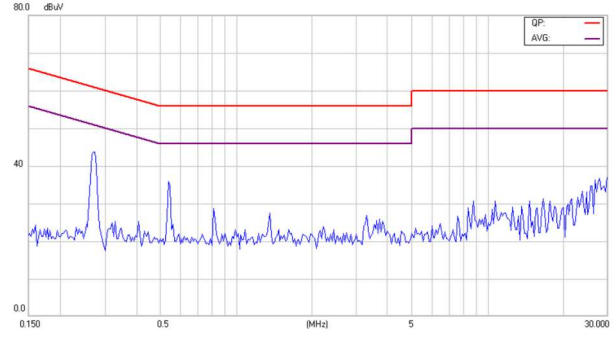

Conducted Class B of EC3SAW-24D05HP

Vin = 24Vdc

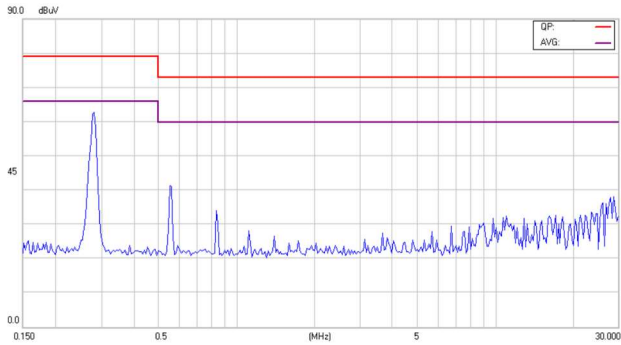

Conducted Class A of EC3SAW-24D12HP

Vin = 24Vdc

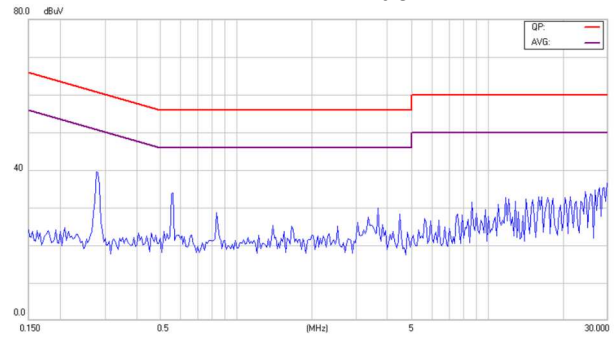

Conducted Class B of EC3SAW-24D12HP

Vin = 24Vdc

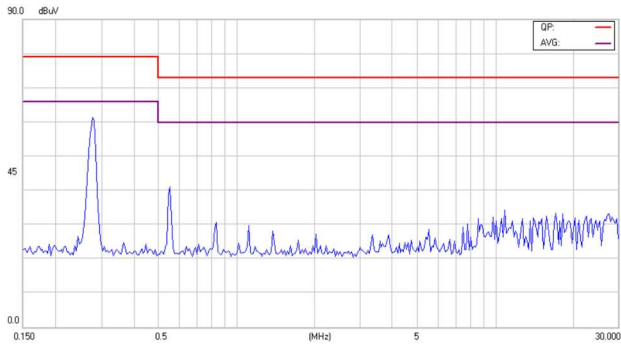

Conducted Class A of EC3SAW-24D15HP

Vin = 24Vdc

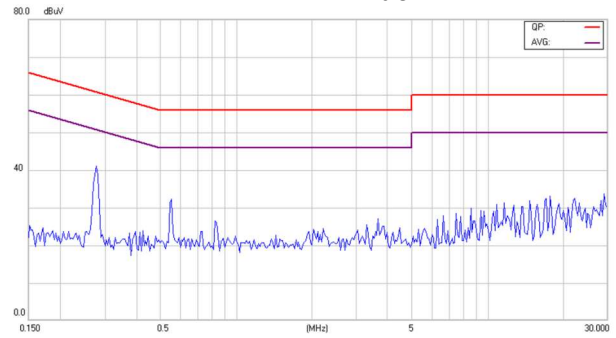

Conducted Class B of EC3SAW-24D15HP

Vin = 48Vdc

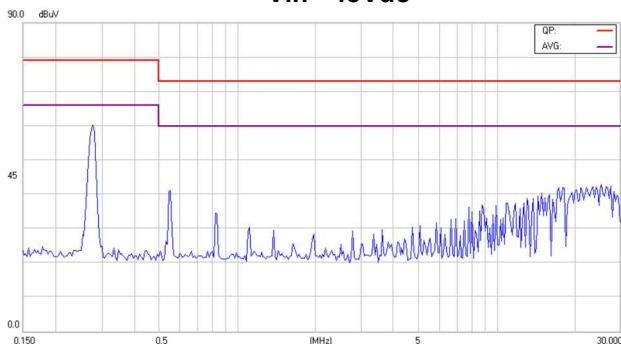

Conducted Class A of EC3SAW-48S33HP

Vin = 48Vdc

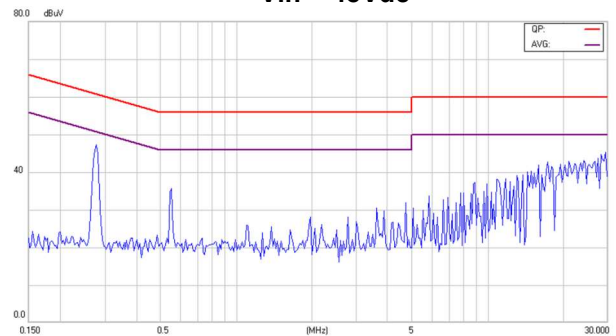

Conducted Class B of EC3SAW-48S33HP



EC3SAWH Series Application Note V10

Vin = 48Vdc

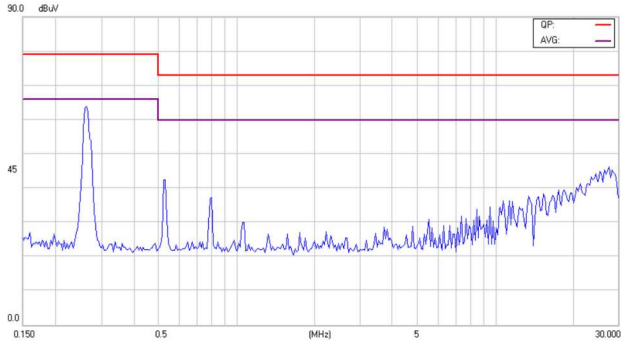

Conducted Class A of EC3SAW-48S05HP

Vin = 48Vdc

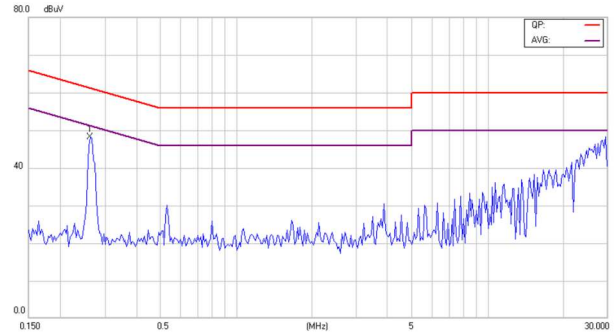

Conducted Class B of EC3SAW48S05HP

Vin = 48Vdc

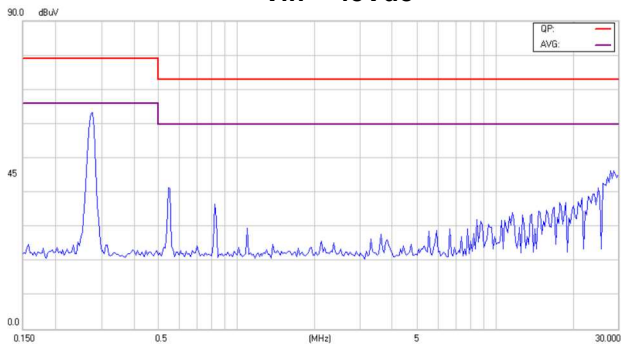

Conducted Class A of EC3SAW-48S12HP

Vin = 48Vdc

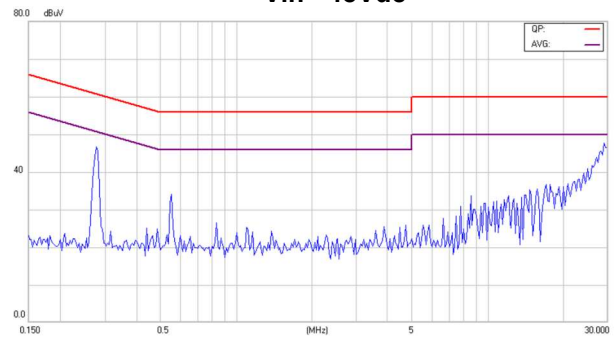

Conducted Class B of EC3SAW-48S12HP

Vin = 48Vdc

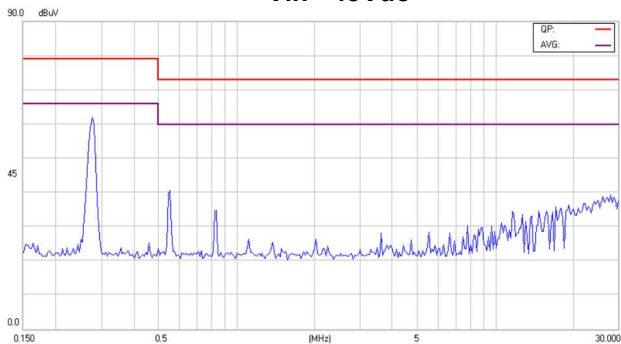

Conducted Class A of EC3SAW-48S15HP

Vin = 48Vdc

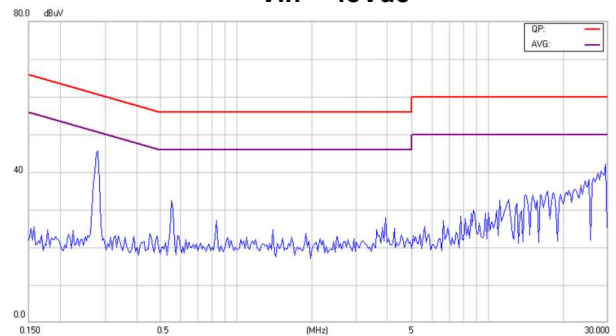

Conducted Class B of EC3SAW-48S15HP

Vin = 48Vdc

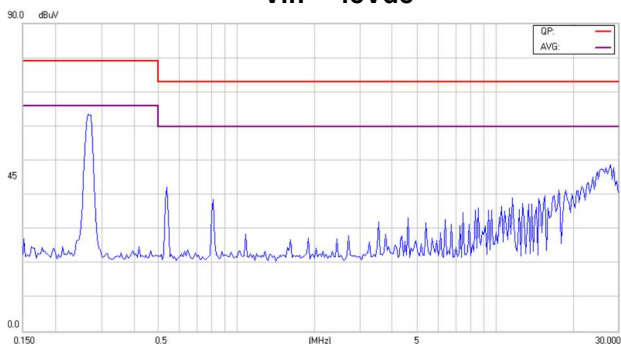

Conducted Class A of EC3SAW-48D05HP

Vin = 48Vdc

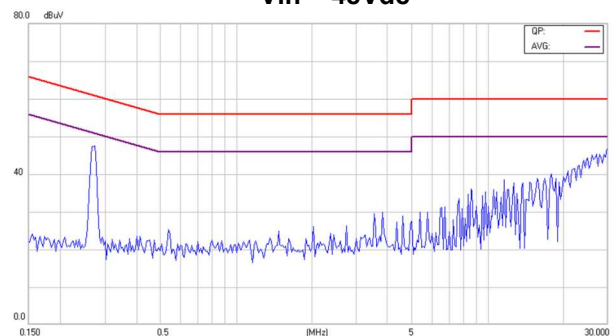

Conducted Class B of EC3SAW48D05HP



EC3SAWH Series Application Note V10

Vin = 48Vdc

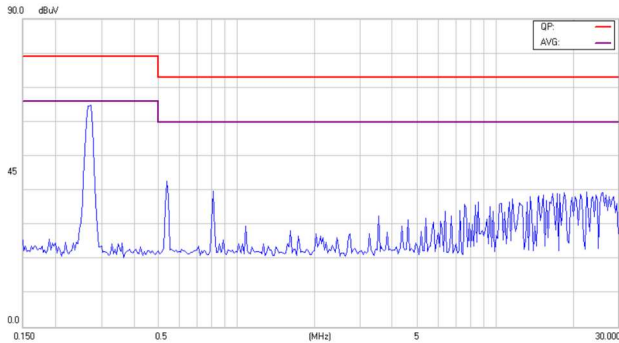

Conducted Class A of EC3SAW-48D12HP

Vin = 48Vdc

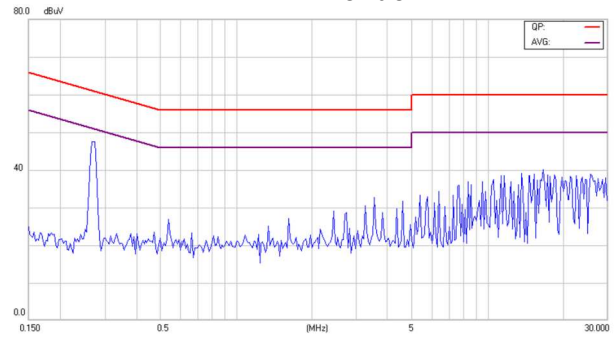

Conducted Class B of EC3SAW-48D12HP

Vin = 48Vdc

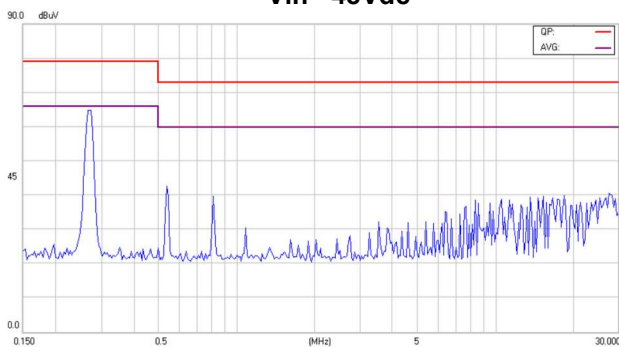

Conducted Class A of EC3SAW-48D15HP

Vin = 48Vdc

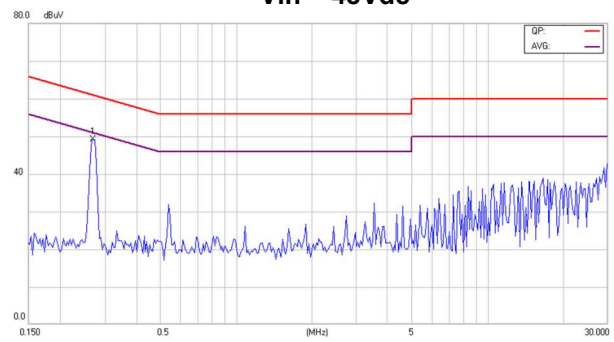

Conducted Class B of EC3SAW-48D15HP

CINCON ELECTRONICS CO., LTD.

Headquarters:

14F, No.306, Sec.4, Hsin Yi Rd.
Taipei, Taiwan
Tel: 886-2-27086210
Fax: 886-2-27029852
E-mail: support@cincon.com.tw
Web: www.cincon.com

Factory:

No. 8-1, Fu Kung Rd.
Fu Hsing Industrial Park
Fu Hsing Hsiang,
ChangHua Hsien, Taiwan
Tel: 886-4-7690261
Fax: 886-4-7698031

Cincon North America:

1655Mesa Verde Ave. Ste 180
Ventura, CA93003
Tel: 805-639-3350
Fax: 805-639-4101
E-mail: info@cincon.com