



EC2SAN SERIES 2W DC-DC Converters

Application Note V10 November 2009

ISOLATED DC-DC Converter EC2SAN SERIES APPLICATION NOTE



Approved By:

Department	Approved By	Checked By	Reported By
Research and Development Department	Enoch	Danny	Eunice
Engineering Department (Quality Assurance)	Jack	Benny	



EC2SAN SERIES 2W DC-DC Converters

Application Note V10 November 2009

Content

1. INTRODUCTION	3
2. DC-DC CONVERTER FEATURES	3
3. ELECTRICAL BLOCK DIAGRAM	3
4. TECHNICAL SPECIFICATIONS	4
5. MAIN FEATURES AND FUNCTIONS	6
5.1 Operating Temperature Range	6
5.2 Output Short Circuit Protection	6
6. APPLICATIONS	6
6.1 Recommended Layout PCB Footprints	6
6.2 Power De-rating curves for EC2SAN Series	7
6.3 Efficiency vs. Load Curves	8
6.4 Input Capacitance at the Power Module	11
6.5 Test Set-Up	11
6.6 Output Ripple and Noise Measurement	11
6.7 Output Capacitance	12
7. SAFETY & EMC	12
7.1 Input Fusing and Safety Considerations.	12
7.2 EMC Considerations	12
8. PART NUMBER	15
9. MECHANICAL OUTLINE DIAGRAMS	15
9.1 Mechanical Outline Diagrams	15
9.2 Packaging Details	16



EC2SAN SERIES 2W DC-DC Converters

Application Note V10 November 2009

1. Introduction

The EC2SAN series offer 2 watts of output power with Industry Standard Single-In-line Package in a 0.77 x 0.28 x 0.40 inches (19.6x7.2 x 10.2mm). The EC2SAN series have a $\pm 10\%$ input voltage range of 5Vdc, 12Vdc and 24Vdc and provide an unregulated output. This series are with features as miniature size, 1000VDC of isolation and allow an operating ambient temperature range of -40°C to 85°C . Furthermore, this series offer a product high performance at low cost. All models are very suitable for telecommunications, distributed power systems, battery operated equipment, industrial, portable equipment applications.

2. DC-DC Converter Features

- Industry Standard SIP Packages
- Efficiency up to 86%
- 1000VDC Isolation
- Low Cost
- Unregulated Outputs
- Low Ripple and Noise
- RoHS compliance

3. Electrical Block Diagram

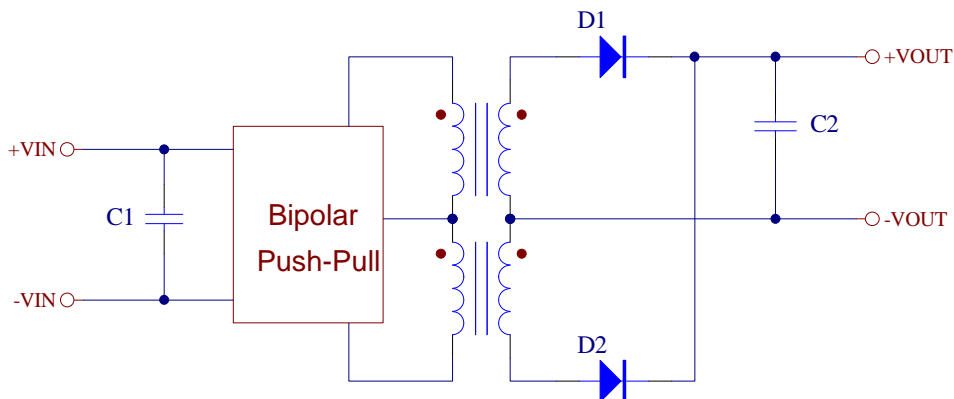

Figure1 Electrical Block Diagram for Single output

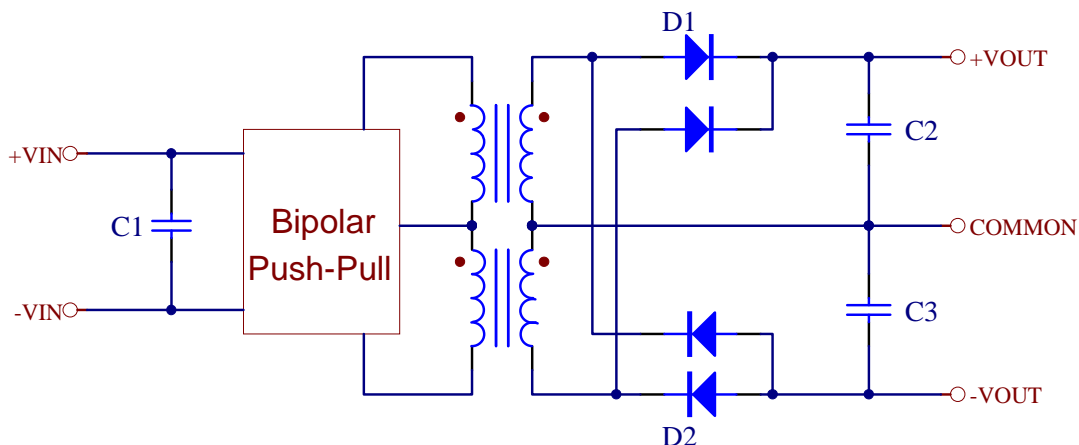

Figure2 Electrical Block Diagram for Dual output



EC2SAN SERIES 2W DC-DC Converters

Application Note V10 November 2009

4. Technical Specifications

(All specifications are typical at nominal input, full load at 25°C unless otherwise noted.)

PARAMETER	NOTES and CONDITIONS	Device	Min.	Typical	Max.	Units
ABSOLUTE MAXIMUM RATINGS						
Input Voltage						
Continuous		EC2SA0XN EC2SA1XN EC2SA2XN	-0.7 -0.7 -0.7		5.5 13.2 26.4	Vdc
Transient (100ms)	100ms	EC2SA0XN EC2SA1XN EC2SA2XN			9 18 30	Vdc
Operating Ambient Temperature	With de-rating, above 75°C		-40		+85	°C
Storage Temperature			-55		+125	°C
Operating Case Temperature			-40		100	°C
Input/Output Isolation Voltage	1 minute		1000			Vdc
INPUT CHARACTERISTICS						
Operating Input Voltage		EC2SA0XN EC2SA1XN EC2SA2XN	4.5 10.8 21.6	5 12 24	5.5 13.2 26.4	Vdc
Maximum Input Current	100% Load, Vin=4.5V for 2SA0XN 100% Load, Vin=10.8V for 2SA1XN 100% Load, Vin=21.6V for 2SA2xN	EC2SA0XN EC2SA1XN EC2SA2XN		500 210 110		mA
No-Load Input Current	Vin=5V Vin=12V Vin=24V	EC2SA0XN EC2SA1XN EC2SA2XN		60 40 20		mA
Inrush Current (I ² t)					0.01	A ² s
OUTPUT CHARACTERISTIC						
Output Voltage Set Point	Vin=Nominal Vin , Io=Io,max, Tc=25°C	Vo=5.0Vdc Vo=12Vdc Vo=15Vdc Vo=±5.0Vdc Vo=±12Vdc Vo=±15Vdc	4.85 11.64 14.55 ±4.85 ±11.64 ±14.55	5.0 12 15 ±5.0 ±12 ±15	5.15 12.36 15.45 ±5.15 ±12.36 ±15.45	Vdc
Output Voltage Regulation						
Load Regulation	Io=20% to 100%				±10	%
Line Regulation	For Vin Change of 1%				±1.2	%
Temperature Coefficient	Ta=-40°C to 85°C				±0.05	%/°C
Output Voltage Ripple and Noise						
Peak-to-Peak	Full Load, 20MHz bandwidth Output with 0.33uF Ceramic Capacitor	EC2SAX1N EC2SAXXN			100 150	mV
Operating Output Current Range		Vo=5.0Vdc Vo=12Vdc Vo=15Vdc Vo=±12Vdc Vo=±15Vdc Vo=±5Vdc	0 0 0 0 0 0		400 167 134 83 67 200	mA
Over Load	Vin=Nominal Vin Output Voltage Within Vo Set Point ±5%	All	120			%
Output Voltage Balance	Vin=nominal, Io=Iomax, Tc=25°C	Dual			±1.0	%
Maximum Output Capacitance	Full load	Vo=5.0Vdc Vo=12Vdc Vo=15Vdc Vo=±5.0Vdc Vo=±12Vdc Vo=±15Vdc			470 470 470 470 470 470	uF
Output Short Circuit	Momentary				1	Sec.



EC2SAN SERIES 2W DC-DC Converters

Application Note V10 November 2009

PARAMETER	NOTES and CONDITIONS	Device	Min.	Typical	Max.	Units
EFFICIENCY						
100% Load	Vin=Nominal Vin, Io=Io.max, Tc=25°C	EC2SA01N EC2SA02N EC2SA03N EC2SA04N EC2SA05N EC2SA06N EC2SA11N EC2SA12N EC2SA13N EC2SA14N EC2SA15N EC2SA16N EC2SA21N EC2SA22N EC2SA23N EC2SA24N EC2SA25N EC2SA26N		82 86 85 86 86 83 82 83 84 82 84 82 79 81 82 81 82 79		%
ISOLATION CHARACTERISTICS						
Input to Output	1 minutes	All	1000			Vdc
Isolation Resistance		All	1000			MΩ
Isolation Capacitance		All		15		pF
FEATURE CHARACTERISTICS						
Switching Frequency	Vin=Nominal Vin, Io=Io.max, Tc=25°C	All		80		KHz
GENERAL SPECIFICATIONS						
MTBF	Io=100%of Io.max;Ta=25°C per MIL-HDBK-217F	All		3.3		M hours
Weight		All		2.7		Grams



EC2SAN SERIES 2W DC-DC Converters

Application Note V10 November 2009

5. Main Features and Functions

5.1 Operating Temperature Range

The EC2SAN series converters can be operated by a wide ambient temperature range from -40°C to 85°C. The standard model has a plastic case and case temperature can not over 100°C at normal operating.

5.2 Output Short Circuit Protection

All different voltage models have a momentary short-circuit protection (1 Second maximum). Please notice this condition and avoid output short as much as possible.

6. Applications

6.1 Recommended Layout PCB Footprints

The system designer or the end user must ensure that other components and metal in the vicinity of the converter meet the spacing requirements to which the system is approved. Low resistance and low inductance PCB layout traces are the norm and should be used where possible. Due consideration must also be given to proper low impedance tracks between power module, input and output grounds. The recommended footprints and soldering profiles are shown as [Figure 3](#).

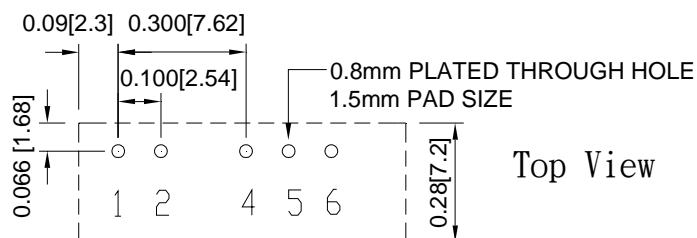

Note: Dimensions are in inches(millimeters)

Lead Free Wave Soldering Profile

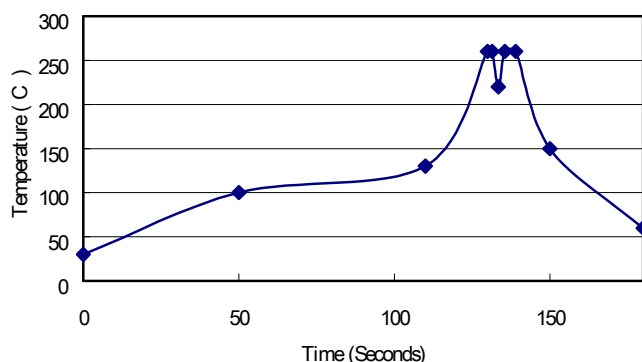

Note :

1. Soldering Materials: Sn/Cu/Ni
2. Ramp up rate during preheat: 1.4 °C/Sec (From 50°C to 100°C)
3. Soaking temperature: 0.5 °C/Sec (From 100°C to 130°C), 60±20 seconds
4. Peak temperature: 260°C, above 250°C 3~6 Seconds
5. Ramp up rate during cooling: -10.0 °C/Sec (From 260°C to 150°C)

Figure3 Recommended PCB Layout Footprints and Soldering Profile



EC2SAN SERIES 2W DC-DC Converters

Application Note V10 November 2009

6.2 Power De-rating curves for EC2SAN Series

Operating Ambient temperature Range: $-40^{\circ}\text{C} \sim 85^{\circ}\text{C}$

Maximum case temperature under any operating condition should not be exceed 100°C .

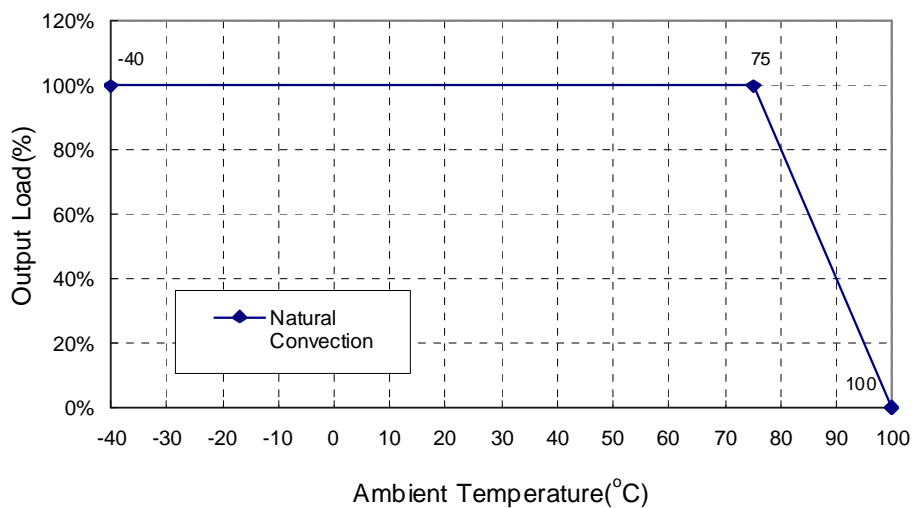

Figure4 Typical Power De-rating Curve for EC2SAN Series



EC2SAN SERIES 2W DC-DC Converters

Application Note V10 November 2009

6.3 Efficiency vs. Load Curves

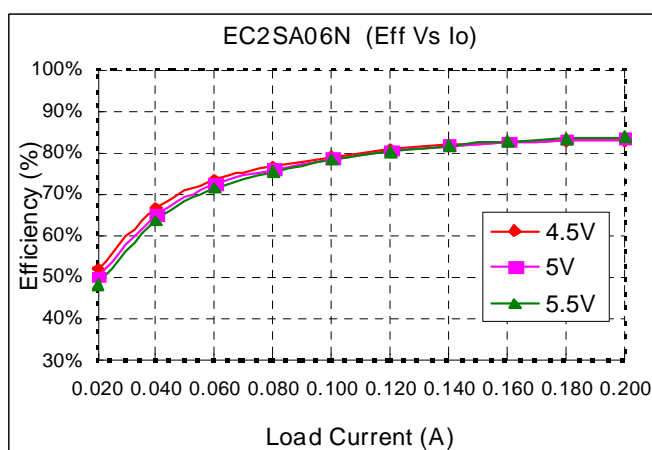
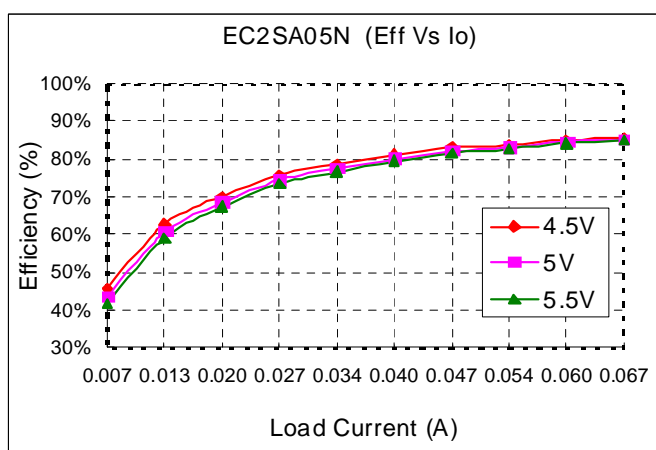
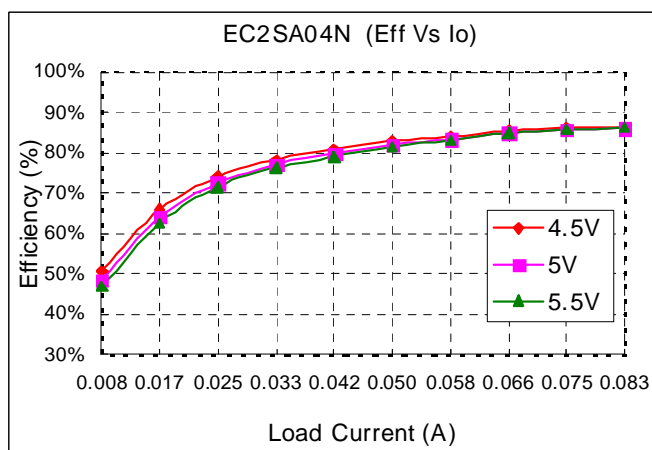
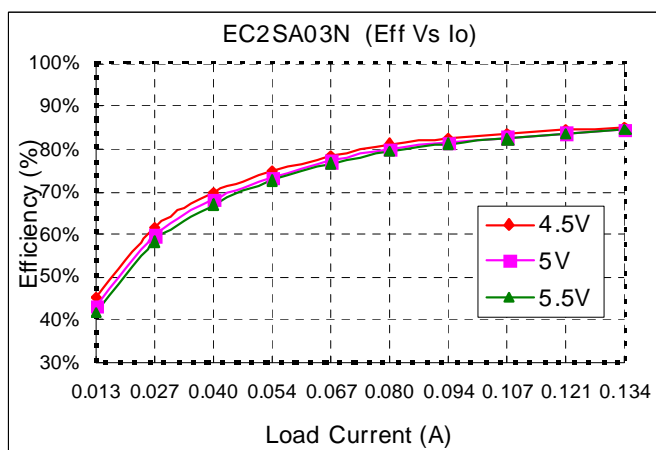
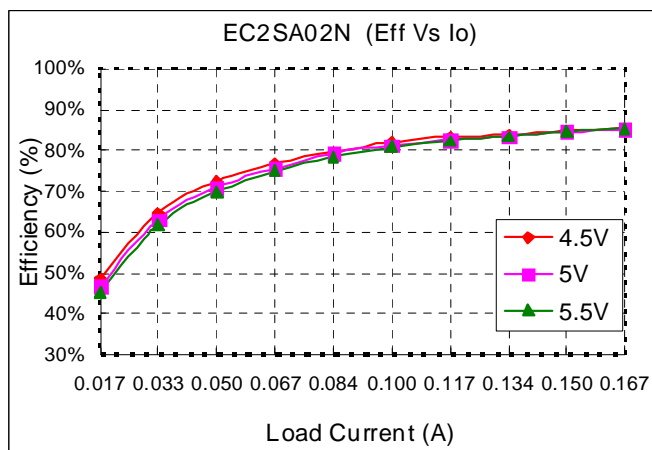
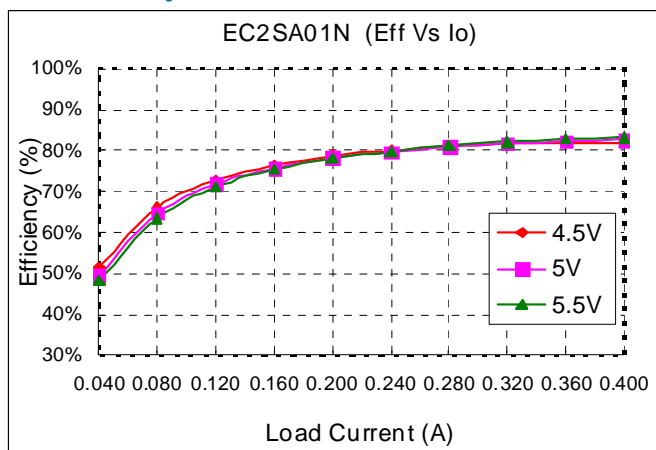



EC2SAN SERIES 2W DC-DC Converters

Application Note V10 November 2009

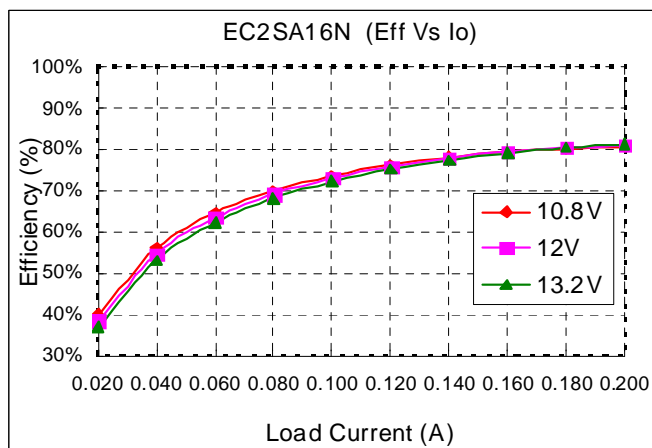
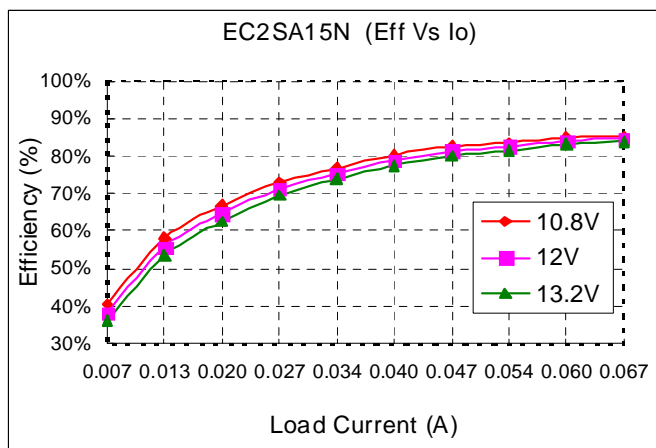
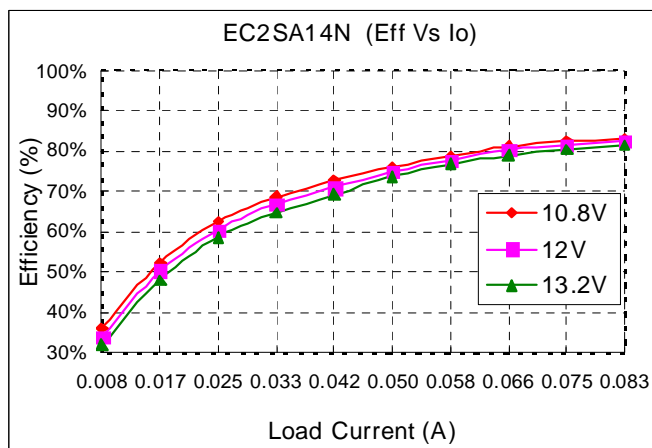
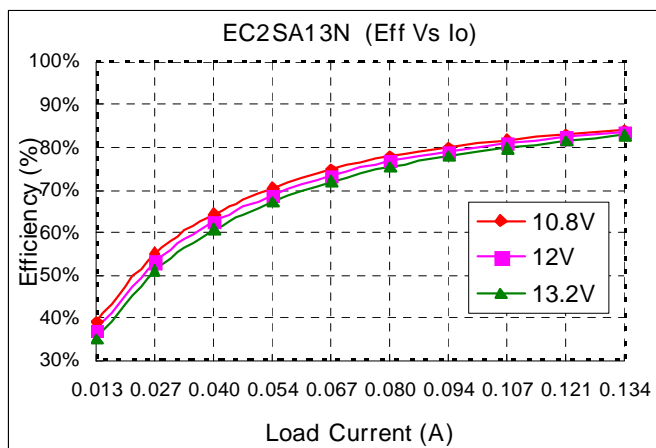
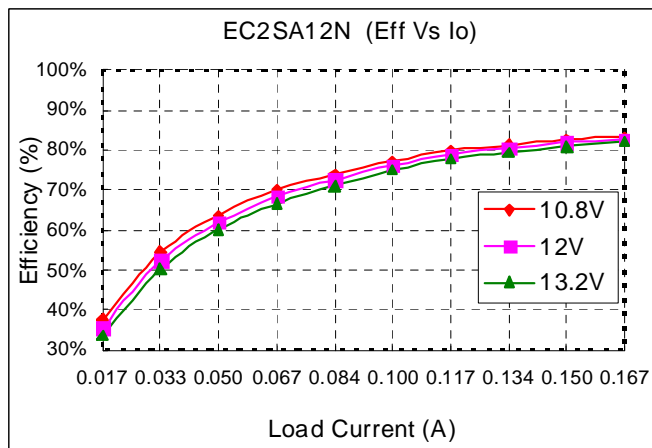
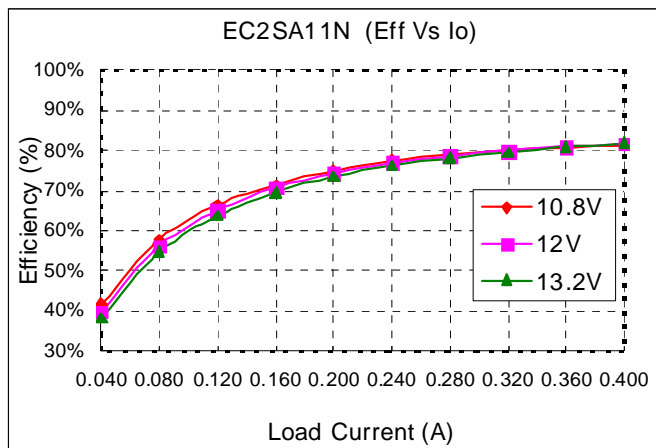



EC2SAN SERIES 2W DC-DC Converters

Application Note V10 November 2009

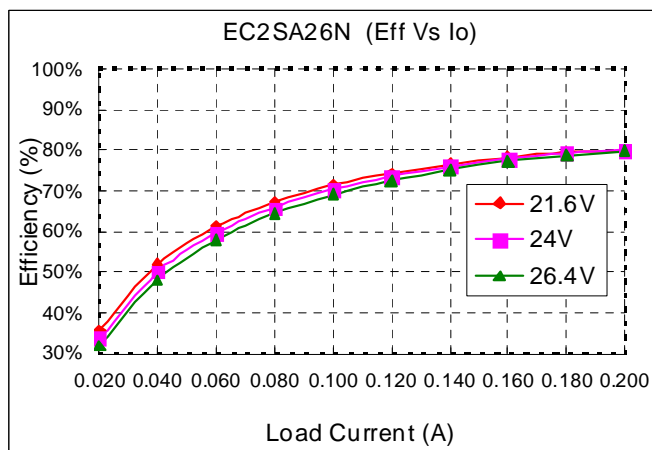
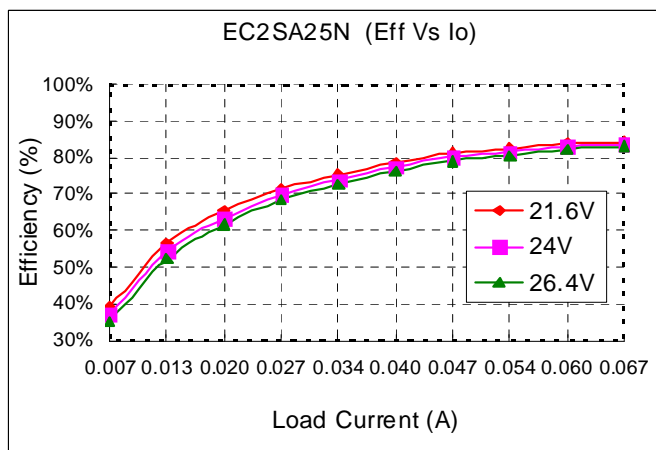
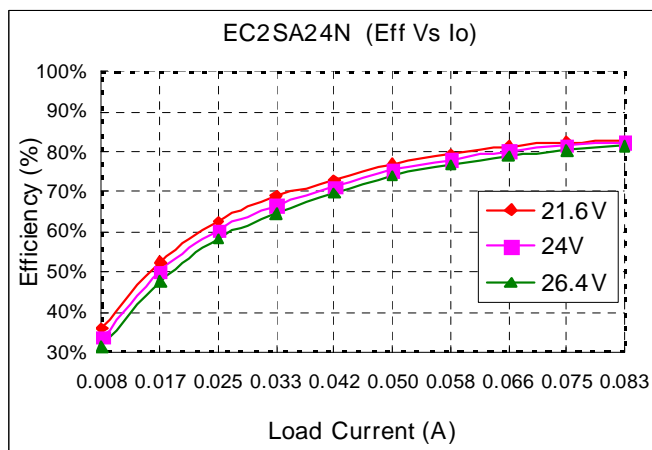
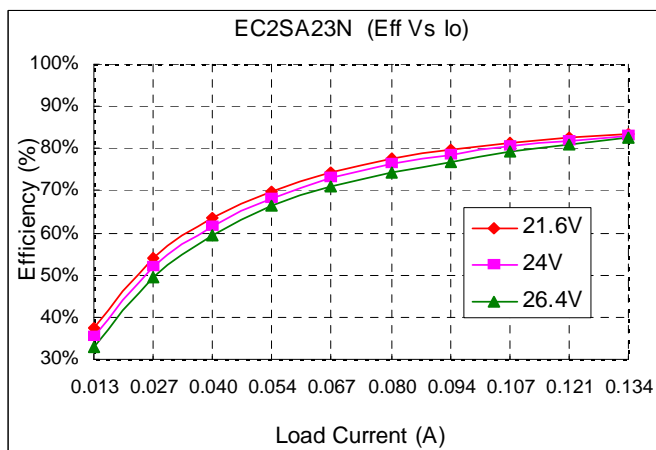
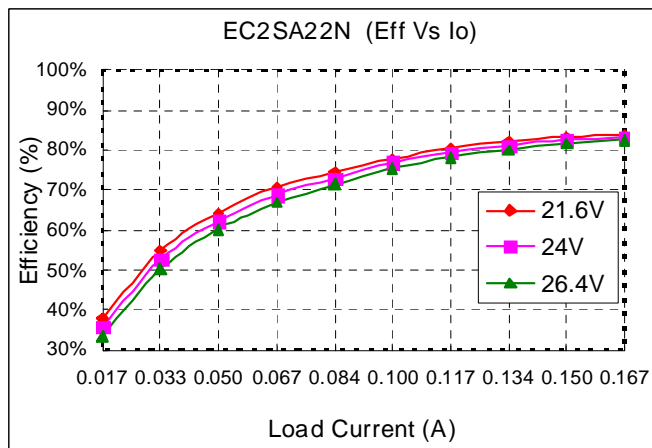
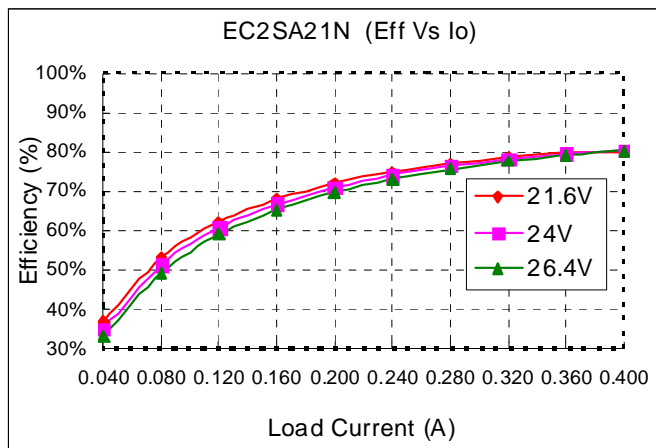



EC2SAN SERIES 2W DC-DC Converters

Application Note V10 November 2009

6.4 Input Capacitance at the Power Module

The converters must be connected to low AC source impedance. To avoid problems with loop stability source inductance should be low. Also, the input capacitors (Cin) should be placed close to the converter input pins to de-couple distribution inductance. However, the external input capacitors are chosen for suitable ripple handling capability. The input capacitors (Cin) are recommended by low ESR capacitors of 2.2uF for 5Vin and 12Vin models or 10uF for 24Vin models. Testing Circuit for reflected ripple current as shown in Figure5 represents typical measurement methods. C1 and L1 simulate a typical DC source impedance. The input reflected-ripple current is measured by current probe to oscilloscope with a simulated source Inductance (L1).

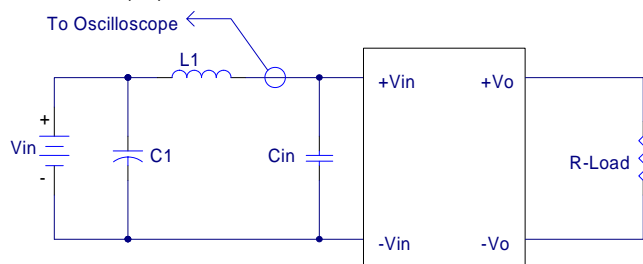

L1: 12uH
 C1: 2.2uF Tantalum capacitor for 5Vin and 12Vin models or 10uFCeramic capacitor for 24Vin models
 Cin: None

Figure5 Input Reflected-Ripple Test Setup

6.5 Test Set-Up

The basic test set-up to measure parameters such as efficiency and load regulation is shown in Figure6 and 7. When testing the modules under any transient conditions please ensure that the transient response of the source is sufficient to power the equipment under test. We can calculate the

- Efficiency
- Load regulation and line regulation.

The value of efficiency is defined as:

$$\eta = \frac{V_o \times I_o}{V_{in} \times I_{in}} \times 100\%$$

Where: Vo is output voltage,
 Io is output current,
 Vin is input voltage,
 Iin is input current.

The value of load regulation is defined as:

$$Load.reg = \frac{V_{FL} - V_{ML}}{V_{ML}} \times 100\%$$

Where: V_{FL} is the output voltage at full load

V_{ML} is the output voltage at 20%full load

Line regulation is per 1.0% change in input voltage. The value of line regulation is defined as:

$$Line.reg = \frac{V_{HL} - V_{LL}}{V_{NOM}} \times 100\%$$

Where: V_{HL} is the output voltage of maximum input voltage at full load.

V_{LL} is the output voltage of minimum input voltage at full load.

V_{NOM} is the output voltage of nominal input voltage at full load.

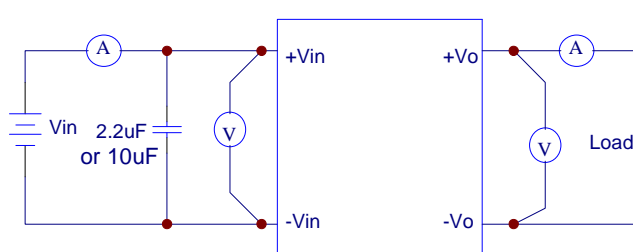

Figure6 EC2SAN Series Single output Test Setup

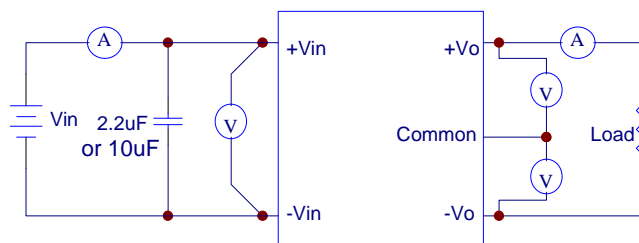

Figure7 EC2SAN Series Dual output Test Setup

6.6 Output Ripple and Noise Measurement

The test set-up for noise and ripple measurements is shown in Figure8 and 9. A coaxial cable was used to prevent impedance mismatch reflections disturbing the noise readings at higher frequencies. Measurements are taken with output appropriately loaded and all ripple/noise specifications are from D.C. to 20MHz Band Width. The output ripple/noise is measured with 0.33uF ceramic capacitor across output. The ripple and noise is measured by BNC at 50mm to 75mm (2" to 3") from the module.

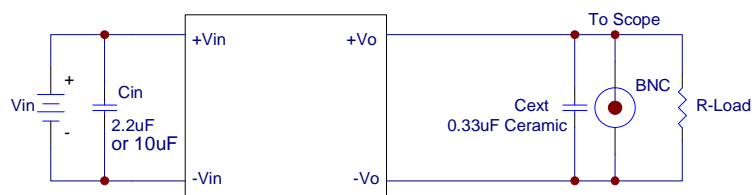

Figure8 Output Voltage Ripple and Noise Measurement Set-up for Single Output



EC2SAN SERIES 2W DC-DC Converters

Application Note V10 November 2009

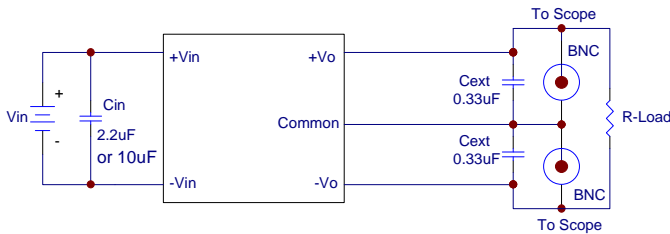

Figure9 Output Voltage Ripple and Noise Measurement Set-up for Dual output

6.7 Output Capacitance

The EC2SAN series converters provide unconditional stability with or without external capacitors. For good transient response low ESR output capacitors should be located close to the point of load. These series converters are designed to work with load capacitance to see technical specifications.

7. Safety & EMC

7.1 Input Fusing and Safety Considerations.

The EC2SAN series converters have not an internal fuse. However, to achieve maximum safety and system protection, always use an input line fuse. We recommended a time delay fuse 1A for 5Vin models, 500mA for 12Vin models and 250mA for 24Vin models. Figure10 circuit is recommended by a Transient Voltage Suppressor diode across the input terminal to protect the unit against surge or spike voltage and input reverse voltage.

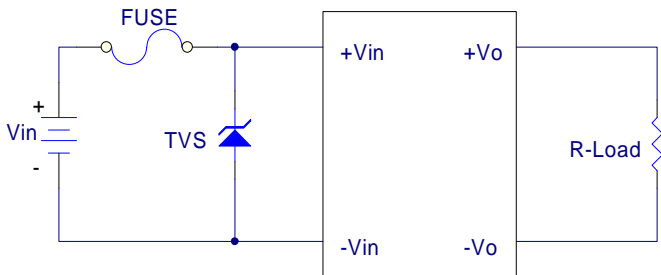

Figure10 Input Protection

7.2 EMC Considerations

EMI Test standard: EN55022 Class A and Class B Conducted Emission
 Test Condition: Input Voltage: Nominal, Output Load: Full Load

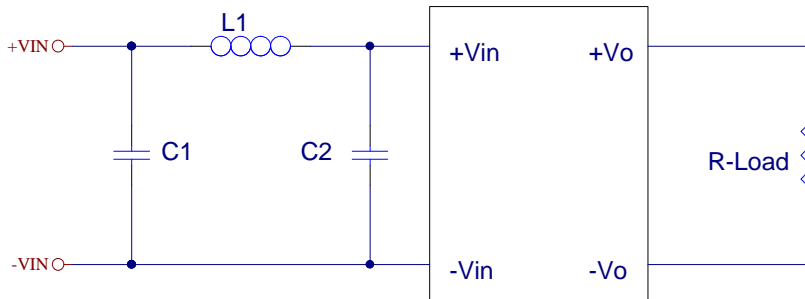

Figure11 Connection circuit for conducted EMI testing



EC2SAN SERIES 2W DC-DC Converters

Application Note V10 November 2009

Model No.	EN55022 class A			EN55022 class B		
	C1	C2	L1	C1	C2	L1
EC2SA01N	4.7uF/50V 1812	NC	2.2uH	10uF/25V 1812	NC	5.6uH
EC2SA02N	4.7uF/50V 1812	NC	2.2uH	10uF/25V 1812	NC	5.6uH
EC2SA03N	10uF/25V 1812	NC	5.6uH	10uF/25V 1812	10uF/25V 1812	5.6uH
EC2SA04N	4.7uF/50V 1812	NC	2.2uH	10uF/25V 1812	NC	5.6uH
EC2SA05N	10uF/25V 1812	NC	5.6uH	10uF/25V 1812	10uF/25V 1812	5.6uH
EC2SA06N	4.7uF/50V 1812	NC	2.2uH	10uF/25V 1812	NC	5.6uH
EC2SA11N	10uF/25V 1812	NC	5.6uH	10uF/25V 1812	10uF/25V 1812	5.6uH
EC2SA12N	4.7uF/50V 1812	NC	5.6uH	10uF/25V 1812	10uF/25V 1812	5.6uH
EC2SA13N	4.7uF/50V 1812	NC	5.6uH	10uF/25V 1812	10uF/25V 1812	5.6uH
EC2SA14N	4.7uF/50V 1812	NC	5.6uH	10uF/25V 1812	10uF/25V 1812	5.6uH
EC2SA15N	4.7uF/50V 1812	NC	5.6uH	10uF/25V 1812	10uF/25V 1812	5.6uH
EC2SA16N	10uF/25V 1812	NC	5.6uH	10uF/25V 1812	10uF/25V 1812	5.6uH
EC2SA21N	4.7uF/50V 1812	4.7uF/50V 1812	5.6uH	10uF/50V 2220	10uF/50V 2220	5.6uH
EC2SA22N	4.7uF/50V 1812	4.7uF/50V 1812	5.6uH	10uF/50V 2220	10uF/50V 2220	5.6uH
EC2SA23N	4.7uF/50V 1812	4.7uF/50V 1812	5.6uH	10uF/50V 2220	10uF/50V 2220	5.6uH
EC2SA24N	4.7uF/50V 1812	4.7uF/50V 1812	5.6uH	10uF/50V 2220	10uF/50V 2220	5.6uH
EC2SA25N	4.7uF/50V 1812	4.7uF/50V 1812	5.6uH	10uF/50V 2220	10uF/50V 2220	5.6uH
EC2SA26N	4.7uF/50V 1812	4.7uF/50V 1812	5.6uH	10uF/50V 2220	10uF/50V 2220	5.6uH

Note: All of capacitors are ceramic capacitors.



EC2SAN SERIES 2W DC-DC Converters

Application Note V10 November 2009

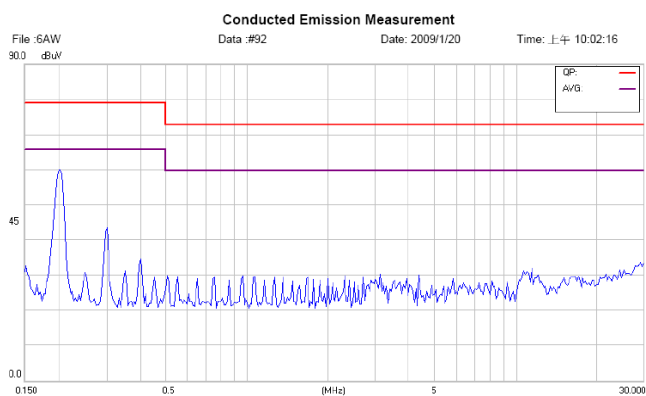

Figure12-1 EMI Conducted Class A for EC2SAN01N

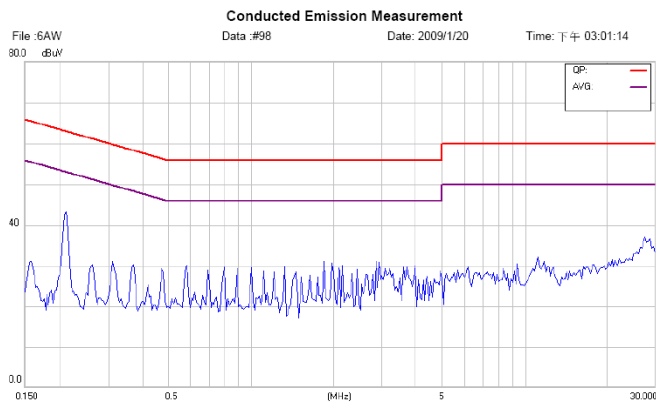

Figure12-2 EMI Conducted Class B for EC2SAN01N

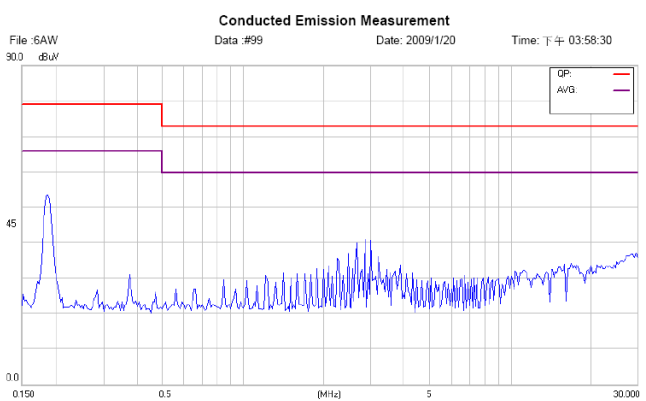

Figure13-1 EMI Conducted Class A for EC2SAN24N

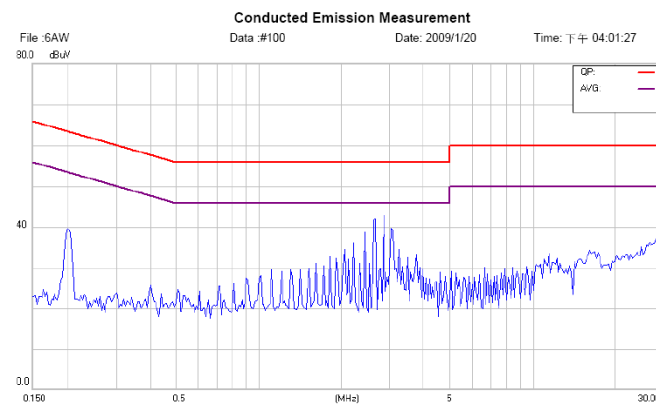

Figure13-2 EMI Conducted Class B for EC2SAN24N



EC2SAN SERIES 2W DC-DC Converters

Application Note V10 November 2009

8. Part Number

EC2SA X X N

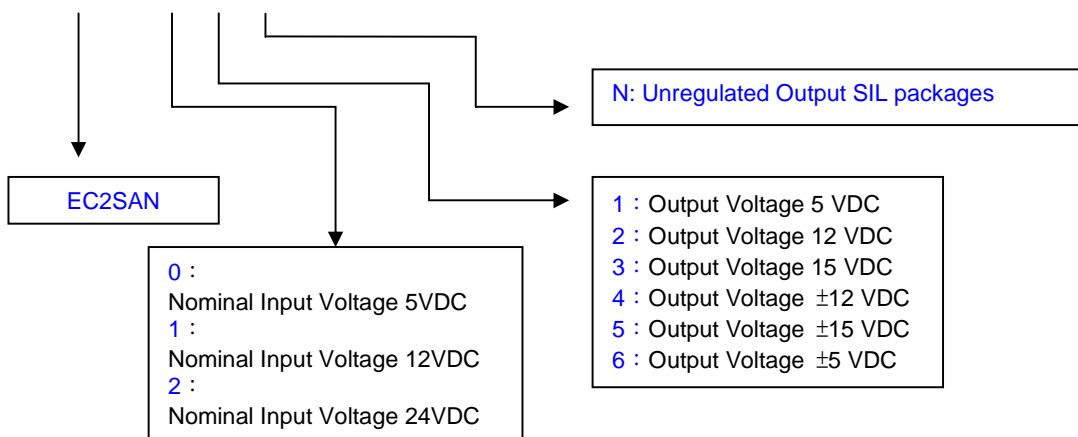

9. Mechanical Outline Diagrams

9.1 Mechanical Outline Diagrams

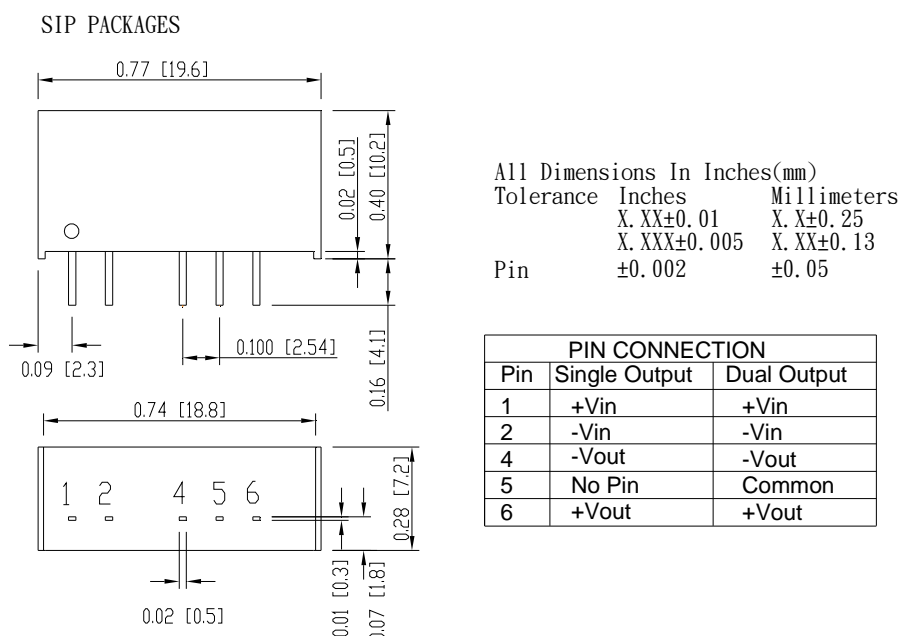

Figure14 EC2SAN Mechanical Outline Diagram



EC2SAN SERIES 2W DC-DC Converters

Application Note V10 November 2009

9.2 Packaging Details

The EC2SAN series SIL version are supplied in Tube(11x20x330mm). Modules are shipped in quantities of 14 modules per Tube. Details of tube dimensions are shown below.

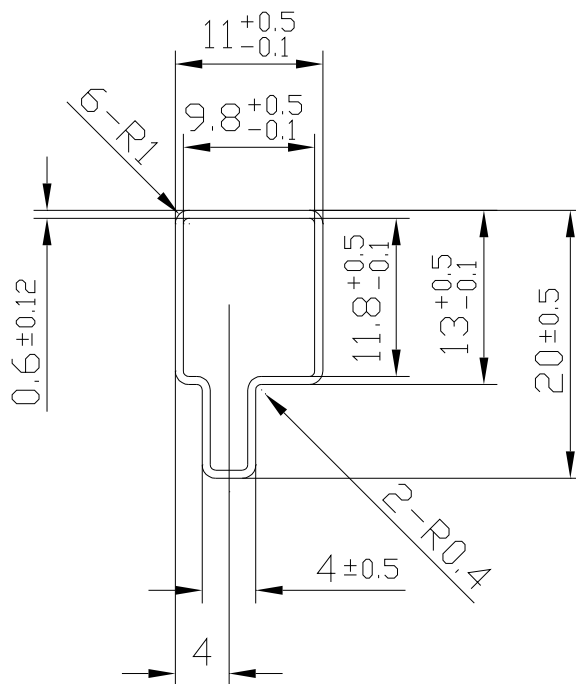

Figure15 SIL Packages Tube for EC2SAN

CINCON ELECTRONICS CO., LTD.

Headquarter Office:

14F, No.306, Sec.4, Hsin Yi Rd.,
Taipei, Taiwan
Tel: 886-2-27086210
Fax: 886-2-27029852
E-mail: support@cincon.com.tw
Web Site: <http://www.cincon.com>

Factory:

No. 8-1, Fu Kong Rd.,
Fu Hsing Industrial Park
Fu Hsing Hsiang, ChangHua Hsien,
Taiwan
Tel: 886-4-7690261
Fax: 886-4-7698031

Cincon American Office:

7770 Telegraph Road, Suite 219,
Ventura, CA 93004
Tel: 805-647-3006
Fax: 805-659-3372
E-mail: escherb@cincon.com