



TR160M SERIES 160 WATT MEDICAL SWITCH ADAPTER

Features

- Universal Input Range 80~264Vac
- High Efficiency up to 93%
- Class I (TR160MA), Class II (TR160MB)
- No Load Input Power Consumption < 150mW
- Approval IEC/EN/UL 60601-1 2 MOPP
- Approval IEC/EN 60601-1-11 (TR160MB)
- Approval IP22 (TR160MB)
- Approval EN55011 and CISPR/FCC Class B
- Operating Altitude 5000m
- Continuous Short Circuit Protection
- Over Voltage Protection
- Meets CoC Tier 2 and DOE Level VI



MODEL NUMBER	OUTPUT VOLTAGE	OUTPUT CURRENT	RIPPLE & NOISE NOTE1	VOLTAGE ACCURACY NOTE2	LINE REGULATION NOTE3	LOAD REGULATION NOTE4	%EFF. (Typ.) NOTE5
TR160MA120	12 V	12.5 A	120 mV	±2%	±1%	±3%	91%
TR160MA240	24 V	6.66 A	200 mV	±2%	±1%	±2%	92%
TR160MA360	36 V	4.44 A	200 mV	±2%	±1%	±2%	92%
TR160MA480	48 V	3.33 A	200 mV	±2%	±1%	±2%	93%
TR160MB120	12 V	12.5 A	120 mV	±2%	±1%	±3%	91%
TR160MB240	24 V	6.66 A	200 mV	±2%	±1%	±2%	92%
TR160MB360	36 V	4.44 A	200 mV	±2%	±1%	±2%	92%
TR160MB480	48 V	3.33 A	200 mV	±2%	±1%	±2%	93%

Note:

1. Add a 0.1uF ceramic capacitor and a 10uF E.L. capacitor to output for ripple & noise measuring @20MHz BW.
2. Voltage accuracy is set at 60% full load.
3. Line regulation is measured from 100V_{ac} to 240V_{ac} with full load.
4. Load regulation measured from 60% to 100% full load and from 60% to 20% full load (60%±40% full load).
5. Typical efficiency at 230V_{ac} and 75% full load at 25°C.

PART NUMBER

Series	Output Voltage	DC Plug Type	Cable Type	Cable Length
TR160M	XXX	-XX	E	XX
160W Medical Adapter	A : Class I B : Class II	120 : 12V 240 : 24V 360 : 36V 480 : 48V	See Page 6 E : UL2464 with OVP	471 : 950mm with Ferrite Core 12 : 1220mm with Ferrite Core 13 : 1800mm with Ferrite Core See page 6 for restrictions

Part Number Example:

TR160MA120-1446E471, 150W, Class I, 12V_{dc} Output, DIN Power Plug Type, Cable Length 950mm with Ferrite Core
TR160MB240-02E13, 160W, Class II, 24V_{dc} Output, DC Jack Type, Cable Length 1800mm with Ferrite Core



TR160M Series

TECHNICAL SPECIFICATIONS

(All specifications are typical at nominal input, full load at 25°C unless otherwise noted.)

ABSOLUTE MAXIMUM RATINGS

PARAMETER	NOTES and CONDITIONS	Device	Min.	Typ.	Max.	Units
Input Voltage		All	80		264	V _{ac}
Operating Temperature	See Derating Curve	All	-20		70	°C
Storage Temperature		All	-40		85	°C
Input/Output Isolation Voltage	1 minute	All			4400	V _{ac}
Operating Altitude		All			5000	m

INPUT CHARACTERISTICS

PARAMETER	NOTES and CONDITIONS	Device	Min.	Typ.	Max.	Units
Operating Voltage Range		All	100		240	V _{ac}
Input Frequency Range		All	47		63	Hz
Maximum Input Current	100% Load, V _{in} =100V _{ac}	All			2.0	A
Leakage Current (Earth)		TR160MA			300	uA
Leakage Current (Touch)		All			90	uA
Under Voltage Protection		All	60	66	70	V _{ac}
Power Factor	230V _{ac} /50Hz at Full load	All	0.9			
Inrush Current	V _{in} =240V _{ac} , Cold start at 25°C	All			120	A

OUTPUT CHARACTERISTICS

PARAMETER	NOTES and CONDITIONS	Device	Min.	Typ.	Max.	Units
Output Voltage Set Point	V _{in} =115V _{ac} and 230V _{ac} , I _o =60% Full load T _c =25°C	TR160MA/B120	11.76	12	12.24	V _{dc}
		TR160MA/B240	23.52	24	24.48	
		TR160MA/B360	35.28	36	36.72	
		TR160MA/B480	47.04	48	48.96	
Operating Output Current Range	V _{in} =115V _{ac} and 230V _{ac} , T _c =25°C	TR160MA/B120	0		12.5	A
		TR160MA/B240	0		6.66	
		TR160MA/B360	0		4.44	
		TR160MA/B480	0		3.33	
Holdup Time	V _{in} =115V _{ac}	All		25		ms
Output Voltage Regulation						
Load Regulation	60%±40% Full load change	TR160MA/B120			±3.0	%
		TR160MA/B240			±2.0	
		TR160MA/B360			±2.0	
		TR160MA/B480			±2.0	
Line Regulation	V _{in} =High line to low line, full load	All			±1.0	%
Over Voltage Protection	Latch off (AC recycle to reset)	TR160MA/B120		13.2		V _{dc}
		TR160MA/B240		28.6		
		TR160MA/B360		41.8		
		TR160MA/B480		55.6		
Over Current Protection	Auto recovery	All	110		130	%
Short Circuit Protection	Auto recovery	All				
Output Ripple and Noise	1. Add a 0.1uF ceramic capacitor and a 10uF aluminum electrolytic capacitor to output 2. Oscilloscope is 20MHz band width 3. Ambient temperature=25°C	TR160MA/B120			120	mV
		TR160MA/B240			200	
		TR160MA/B360			200	
		TR160MA/B480			200	



TR160M Series

PARAMETER	NOTES and CONDITIONS	Device	Min.	Typ.	Max.	Units
Load Capacitance	1. $V_{in}=115V_{ac}$ and $230V_{ac}$ 2. Output is max. load 3. Ambient temperature= $25^{\circ}C$	TR160MA/B120			12250	uF
		TR160MA/B240			6600	
		TR160MA/B360			4330	
		TR160MA/B480			3240	
Efficiency	1. $V_{in}=230V_{ac}$ 2. Output is 75% full load 3. Ambient temperature= $25^{\circ}C$	TR160MA/B120		91%		%
		TR160MA/B240		92%		
		TR160MA/B360		92%		
		TR160MA/B480		93%		

ISOLATION CHARACTERISTICS

PARAMETER	NOTES and CONDITIONS	Device	Min.	Typ.	Max.	Units
Input to Output	1 Minute (without dielectric breakdown)	All			4400	V_{ac}
Input to Earth (Ground)	1 Minute (without dielectric breakdown)	TR160MA			1800	V_{ac}
Output to Earth (Ground)	1 Minute (without dielectric breakdown)	TR160MA			1800	V_{ac}
Isolation Resistance	Input to output	All	100			M Ω

FEATURE CHARACTERISTICS

PARAMETER	NOTES and CONDITIONS	Device	Min.	Typ.	Max.	Units
Switching Frequency		All		115		kHz

GENERAL SPECIFICATIONS

PARAMETER	NOTES and CONDITIONS	Device	Min.	Typ.	Max.	Units
MTBF	$I_o=100\%$; $T_a=25^{\circ}C$ per MIL-HDBK-217F $I_o=100\%$; $T_a=25^{\circ}C$, Telcordia SR332	All	455			k hours
Humidity	Non-condensing	All			93	% RH
Life Time	@75% Load, $40^{\circ}C$	All	26			k hours
Shock	MIL-STD-810F Table 516.5, TABLE 516.5-I 10ms, each axis 3 times($\pm X$ 、 $\pm Y$ 、 $\pm Z$ axis)	All		75		g
Vibration	MIL-STD-810F Table 514.5C-VIII, 15~2000Hz, X、Y、Z axis, 1 hour(each axis),. total 3 hours.	All		4		g
Weight		All		575		grams
Dimension		All	5.906x2.756x1.496 inches (150.00x70.00x38.00 mm)			
Safety	Class I (TR160MA), Class II (TR160MB) IEC 60601-1:2005/AMD2:2020, EN 60601-1:2006;A1+A12+A2 ANSI/AAMI ES60601-1:2005 & A1:2012 & A2:2021 IEN/EN 60601-1-11-2015+A1 for TR160MB (Home Health Care)					Ed 3.2
EMC Emission	EN 55011:2016+A1:2017+A11:2020+A2:2021, EN 61000-3-2:2018, EN 6100-3-3:2013+A1:2017, 47 CFR FCC Part 18					
Conducted Disturbance	EN55011:2016+A1:2017+A11:2020+A2:2021, 47 CFR FCC Part 18					Class B
Radiated Disturbance	EN55011:2016+A1:2017+A11:2020+A2:2021, 47 CFR FCC Part 18					Class B
Harmonic Current Emissions	EN 61000-3-2:2018					Class A
Voltage Fluctuations & Flicker	EN 61000-3-3:2013+A1:2017					Criterion A
EMC Immunity	EN 60601-1-2:2015+A1:2021, IEC61000-4-2, 3, 4, 5, 6, 8, 11					Ed 4.1
Electrostatic Discharge (ESD)	IEC 61000-4-2:2008 Air Discharge: $\pm 15kV$ Contact Discharge: $\pm 8kV$					Criterion A
Radio-Frequency, Continuous Radiated Disturbance	IEC 61000-4-3:2020					Criterion A
Electrical Fast Transient (EFT)	IEC 61000-4-4:2012, $\pm 2kV$					Criterion A
Surge	IEC 61000-4-5:2014+A1:2017, L-N: $\pm 1kV$, L-E (Ground): $\pm 1kV$, $\pm 2kV$					Criterion A
Conducted Disturbances, Induced by RF Fields	IEC 61000-4-6:2013+COR1:2015					Criterion A
Power Frequency Magnetic Field	IEC 61000-4-8:2009					Criterion A



TR160M Series

GENERAL SPECIFICATIONS

Voltage Dips	IEC 61000-4-11:2020, Dips:30% reduction, Dips: >95% reduction	Criterion A
Voltage Interruptions	IEC 61000-4-11:2020, >95% reduction	Criterion B
Application Note Link	TR160M Series App Notes	

CHARACTERISTIC CURVE

Power Derating Curve

TR160M Derating Curve

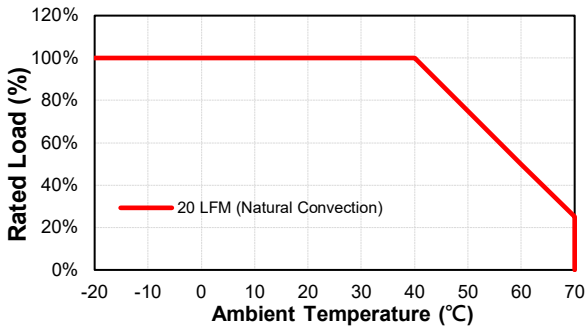

TR160M Input Voltage Derating Curve

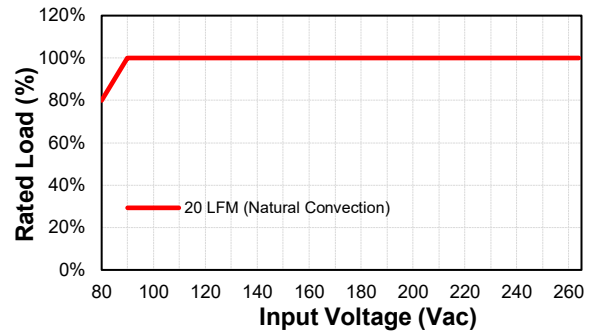

Performance Data

TR160M120 (Eff Vs Io)

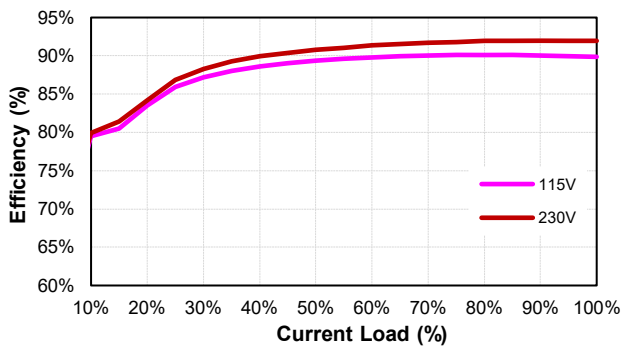

TR160M240 (Eff Vs Io)

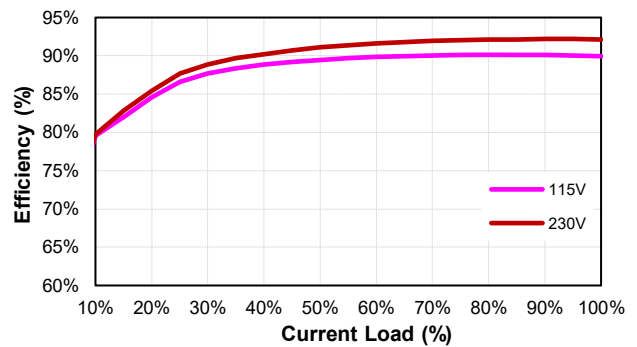

TR160M360 (Eff Vs Io)

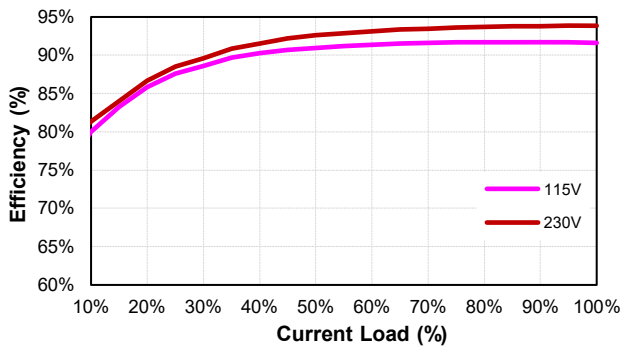

TR160M480 (Eff Vs Io)

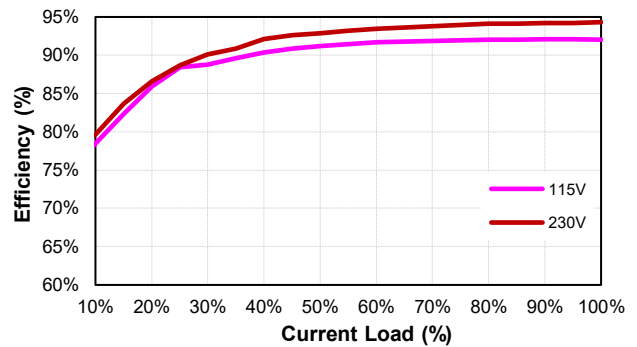

MECHANICAL SPECIFICATION

All Dimensions are in inches[mm]
 Tolerance:Inches:X.XXX±0.02
 Millimeters:X.XX±0.5
 UNIT:inches[mm]

Din Power Plug

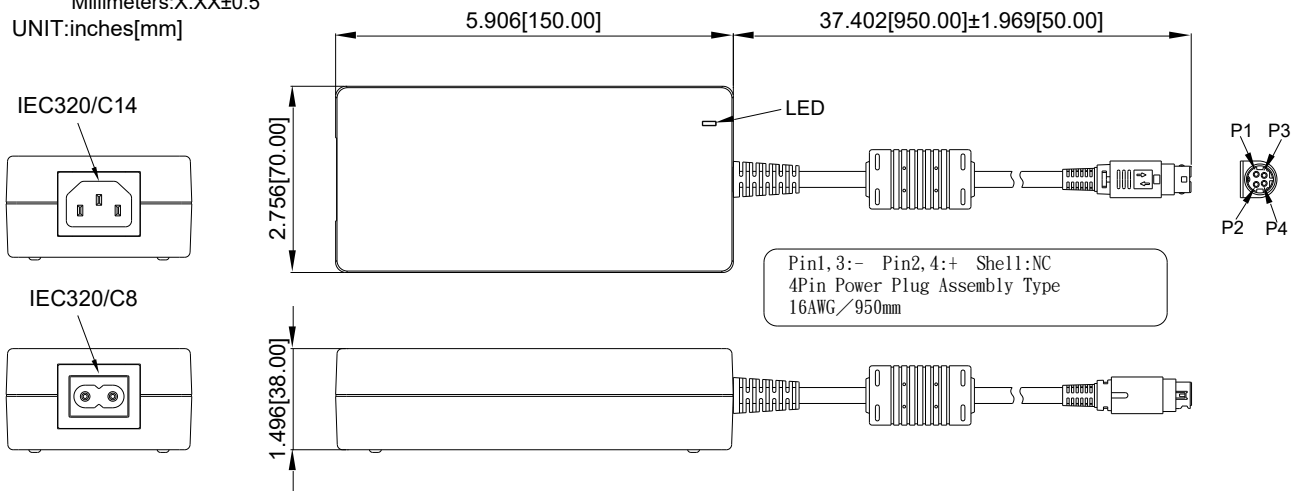

DC Jack

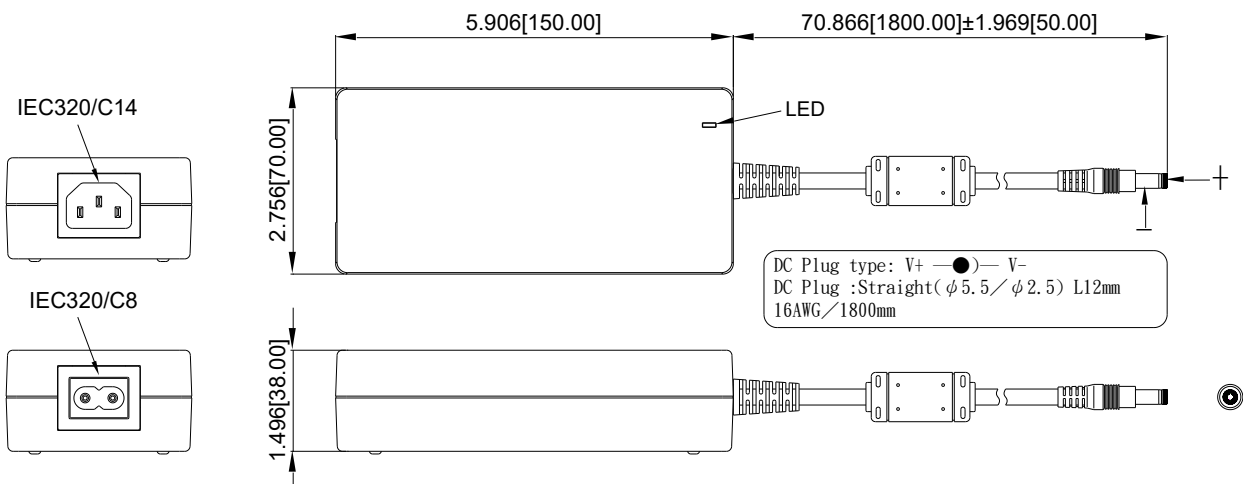

* For Output Voltage 12Vdc model, it must select Din Power Plug Molded Type or equivalent

* For Output Voltage 24Vdc to 48Vdc models, it's able to select Din Power Plug Molded Type, DC Jack or equivalent.



TR160M Series

STANDARD OUTPUT DC PLUG

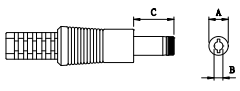
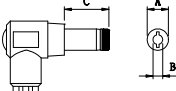
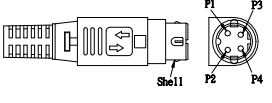
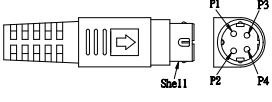
DC Plug Type	Cable Number-XXXXX	A	B	C	Cable Type	Cable Length	Cable AWG
		OD (mm)	ID (mm)	L (mm)			
 <p>Straight/Inner+Outer- + ● -</p>	11E13	Φ5.5	Φ2.1	12	UL2464	1800mm with Ferrite Core	16AWG for 24V, 36V, 48V
	12E13	Φ5.5	Φ2.5	12			
	23E13	Φ5.5	Φ2.1	9.5			
	26E13	Φ5.5	Φ2.5	9.5			
 <p>Right Angle/Inner+Outer- + ● -</p>	01E13	Φ5.5	Φ2.1	12			
	02E13	Φ5.5	Φ2.5	12			
	21E13	Φ5.5	Φ2.5	9.5			
	24E13	Φ5.5	Φ2.1	9.5			
Din Plug Type	Cable Number-XXXXX	Pin Assignment		Cable Type	Cable Length	Cable AWG	
		PIN No.	Polarity				
KYCON KPPX-4P equivalent with Lock (Din Power Plug Assembly Type) 	1446E471	P1	-	UL2464	950mm with Ferrite Core	16AWG for Vo: 12V	
		P2	+				
		P3	-				
		P4	+				
		Shell	No Connection				
KYCON KPPX-4P equivalent without Lock (Din Power Plug Molded Type) 	1538E471	P1	+				
		P2	+				
		P3	-				
		P4	-				
		Shell	No Connection				

※Other DC Plug Type please refer to the link: <https://www.cincon.com/productdownload/TR160M-cable-DC-plug.pdf>