



CFM500M SERIES 500 WATT MEDICAL AC-DC POWER SUPPLY WITH PFC

Features

- Universal Input Range 80~264V_{ac}
- High Efficiency up to 94.5%
- 3"x 5" Compact Size
- Class I & II
- No Load Power Consumption<0.5W
- Peak Power Operation up to 600Watt for 5s
- Approval IEC/EN/UL 60601-1 2 MOPP
- Approval EN 55011, 47 CFR FCC Part 18
- Active PFC Meets EN 61000-3-2
- Design Meets IEC/EN 60335-1
- Operating Altitude 5000m
- High Power Density up to 21.64W/Inch³
- 390W Natural, 470 ~ 500W Conduction Convection
- Over Temperature Protection
- PS On/Off Remote Control
- Power Good & Power Fail Signal
- +5V Stand-by, 12V Fan Output
- Low Inrush Current



MODEL NUMBER	OUTPUT VOLTAGE	OUTPUT CURRENT			VOLTAGE ACCURACY NOTE2	RIPPLE & NOISE NOTE3	VOLTAGE ADJ. RANGE	LINE REGULATION NOTE4	LOAD REGULATION NOTE5	%EFF. (Typ.)
		NOTE1		COVER						
		With FAN	Without FAN							
CFM500M120	12 V	41.67A	27.5A	25A	±1%	120mV	11.4~12.6 V	±0.5%	±1%	92.5%
CFM500M180	18 V	27.78A	18.33A	16.67A	±1%	150mV	17.1~18.9 V	±0.5%	±1%	93.5%
CFM500M240	24 V	20.83A	17.08A	15.83A	±1%	150mV	22.8~25.2 V	±0.5%	±1%	94.5%
CFM500M360	36 V	13.89A	11.39A	10.56A	±1%	200mV	34.2~37.8 V	±0.5%	±1%	94.5%
CFM500M480	48 V	10.42A	8.54A	7.92A	±1%	250mV	45.6~50.4 V	±0.5%	±1%	94.5%
Stand-by Output Voltage										
All	+5V	1A			±3%	100mV	---	±1%	±5%	---
Fan Output Voltage										
All	+12V	0.5A (NOTE 6)			---	---	---	---	---	---

Note:

1. Forced air convection with 21CFM Fan.
2. Voltage accuracy is set at 100% full load and 25°C Ta.
3. Add a 0.1uF ceramic capacitor and a 10uF E.L. capacitor to output for ripple & noise measuring @20MHz BW.
4. Line regulation is measured from high line to low line with 100% full load.
5. Load regulation is measured from 10% to 100% full load.
6. Fan output can only operate normal when the stand-by output is above 0.5A.

PART NUMBER

Series	Number of Outputs	Nominal Output Voltage	Type	Output Terminal
CFM500	X	XXX	X (Option)	-X(Option)
CFM500	M : Medical	120 : 12V 180 : 18V 240 : 24V 360 : 36V 480 : 48V	None : With Baseplate C : With Cover	None : Vertical R : Horizontal

Part Number Example:

- CFM500M120:** With Baseplate, 500W, 12Vdc Output, Vertical Type Terminal
- CFM500M120C:** With Cover, 500W, 12Vdc Output, Vertical Type Terminal
- CFM500M120-R:** With Baseplate, 500W, 12Vdc Output, Horizontal Type Terminal
- CFM500M120C-R:** With Cover, 500W, 12Vdc Output, Horizontal Type Terminal



CFM500M Series

TECHNICAL SPECIFICATIONS

(All specifications are typical at nominal input, full load at 25°C unless otherwise noted.)

ABSOLUTE MAXIMUM RATINGS

PARAMETER	NOTES and CONDITIONS	Device	Min.	Typ.	Max.	Units
Input Voltage	Safety approvals only to the AC input	All	80		264	V _{ac}
Operating Temperature	See Derating Curve	All	-40		85	°C
Maximum Case Temperature	At the Center of Base Plate (T _c = Case temperature)	All	-40		85	°C
Storage Temperature		All	-40		85	°C
Operating Altitude		All			5000	m

INPUT CHARACTERISTICS

PARAMETER	NOTES and CONDITIONS	Device	Min.	Typ.	Max.	Units
Operating Voltage Range		All	100		240	V _{ac}
Input Frequency Range		All	47		63	Hz
Maximum Input Current	100% Full Load, V _{in} =100V _{ac}	All			6	A
Power Factor	V _{in} =230V _{ac}	All		0.97		
Leakage Current (Earth)		All			300	uA
Leakage Current (Touch)		All			100	uA
Inrush Current	V _{in} =240V _{ac} , Cold start at 25°C	All		8.5		A

OUTPUT CHARACTERISTICS

PARAMETER	NOTES and CONDITIONS	Device	Min.	Typ.	Max.	Units
Output Voltage Set Point	V _{in} =Nominal V _{in} , I _o =I _o max., T _c =25°C	CFM500M120	11.88	12	12.12	V _{dc}
		CFM500M180	17.82	18	18.18	
		CFM500M240	23.76	24	24.24	
		CFM500M360	35.64	36	36.36	
		CFM500M480	47.52	48	48.48	
Operating Output Current Range	V _{in} =80V _{ac} ~264V _{ac} , See Derating Curve	CFM500M120			41.67	A
		CFM500M180			27.78	
		CFM500M240			20.83	
		CFM500M360			13.89	
		CFM500M480			10.42	
Holdup Time	V _{in} =115V _{ac}	All		16		ms
Output Voltage Regulation						
Load Regulation	10% to 100% full load	All			±1.0	%
Line Regulation	V _{in} =High line to low line	All			±0.5	%
Over Voltage Protection	Latch off (AC recycle to reset)	CFM500M120			16	V _{dc}
		CFM500M180			30	
		CFM500M240			35	
		CFM500M360			50	
		CFM500M480			63	
Over Current Protection	Auto recovery	All	120		190	%
Peak Power	1. V _{in} =115V _{ac} and 230V _{ac} 2. Ambient temperature=25°C 3. Peak power should be less than 5seconds, with a maximum 10% duty cycle, peak power function by 120% load 5S and 75% load 45S	All		120		%
Short Circuit Protection	Auto recovery	All				
Over Temperature Protection	Auto recovery	All				



CFM500M Series

PARAMETER	NOTES and CONDITIONS	Device	Min.	Typ.	Max.	Units
Output Ripple and Noise	1. Add a 0.1uF ceramic capacitor and a 10uF aluminum electrolytic capacitor to output 2. Oscilloscope is 20MHz bandwidth 3. Ambient temperature=25°C	CFM500M120			120	mV
		CFM500M180			150	
		CFM500M240			150	
		CFM500M360			200	
		CFM500M480			250	
Load Capacitance	1. $V_{in}=115V_{ac}$ and $230V_{ac}$ 2. Output is 100% full load 3. Ambient temperature=25°C	CFM500M120			42900	uF
		CFM500M180			28600	
		CFM500M240			20800	
		CFM500M360			14000	
		CFM500M480			10800	
Efficiency	1. $V_{in}=230V_{ac}$ 2. Output is 100% full load 3. Ambient temperature=25°C	CFM500M120		92.5		%
		CFM500M180		93.5		
		CFM500M240		94.5		
		CFM500M360		94.5		
		CFM500M480		94.5		
PS-On Signal	Power on	All	0		2	V_{dc}
	Power off (PS-ON and GND open)			4		
	Power on (PS-ON and GND short)			10		mA
	Power-off (PS-ON and GND open)			0		
Power Good (PG)	1. $V_{in}=80V_{ac}\sim 264V_{ac}$ 2. Output is 100% full load 3. The TTL goes high after power set up	All	100		500	ms
Power Fail (PF)	1. $V_{in}=80V_{ac}\sim 264V_{ac}$ 2. Output is 100% full load 3. The TTL goes low before V_o below 90% rated value	All	1	10		ms

ISOLATION CHARACTERISTICS

PARAMETER	NOTES and CONDITIONS	Device	Min.	Typ.	Max.	Units
Input to Output	1 Minute	All			4000	V_{ac}
Input to Earth (Ground)	1 Minute (without dielectric breakdown)	All			1800	V_{ac}
Output to Earth (Ground)	1 Minute (without dielectric breakdown)	All			1800	V_{ac}
Isolation Resistance	Input to output	All	100			MΩ

FEATURE CHARACTERISTICS

PARAMETER	NOTES and CONDITIONS	Device	Min.	Typ.	Max.	Units
Switching Frequency	$P_{out}=\text{max. rated power}$	All		65		kHz
Output Voltage adjustment		All	-5		+5	%

GENERAL SPECIFICATIONS

PARAMETER	NOTES and CONDITIONS	Device	Min.	Typ.	Max.	Units
MTBF	$I_o=100\%$; $T_a=25^\circ\text{C}$ per MIL-HDBK-217F	All		200		k hours
Humidity	Non-condensing	All			93	% RH
Shock	Meet MIL-STD-810F Table 516.5, Table 516.5-I 10ms, each axis 3 times ($\pm X$ · $\pm Y$ · $\pm Z$ axis)	All		75		g
Vibration	Meet MIL-STD-810F Table 514.5C-VIII, 15~2000Hz, X · Y · Z axis, 1 hour (each axis),. Total 3 hrs.	All		4		g
Weight	Baseplate versions	All		515		g
	Covered versions			635		
Dimensions	With baseplate	All	5.000x3.000x1.540 Inches (127.00x76.20x39.10 mm)			
	C (with cover)		5.354x3.425x1.673 Inches (136.00x87.00x42.50 mm)			



CFM500M Series

GENERAL SPECIFICATIONS

Safety	Class I & II IEC 60601-1:2005, IEC 60601-1:2005/AMD1:2012, IEC 60601-1:2005/AMD2:2020 EN 60601-1:2006+A1+A12+A2 ANSI/AAMI ES60601-1 (2005/(R)2012+A1:2012, C1:2009/(R)2012+A2:2010/(R)2012)	Ed 3.2
EMC Emission	EN 55011: 2016+A1:2017+A11:2020+A2:2021, EN IEC 61000-3-2:2019+A1: 2021 IEC 61000-3-3:2013+A2: 2021, 47 CFR FCC Part 18	
Conducted Disturbance	EN 55011: 2016+A1 :2017+A11 :2020+A2 :2021, 47 CFR FCC Part 18	Class B
Radiated Disturbance	EN 55011: 2016+A1 :2017+A11 :2020+A2 :2021, 47 CFR FCC Part 18 (Class II Only Meets to Class A, Class B Must Add Parts, Refer to Application Note)	Class B
Harmonic Current Emissions	EN IEC 61000-3-2:2019+A1:2021	Class A, C, D
Voltage Fluctuations & Flicker	IEC 61000-3-3:2013+A2: 2021	
EMC Immunity	EN 60601-1-2:2015+A1: 2021, IEC 61000-4-2, 3, 4, 5, 6, 8, 11	Ed 4.1
Electrostatic Discharge (ESD)	IEC 61000-4-2:2009, Air Discharge: $\pm 15\text{kV}$, Contact Discharge: $\pm 8\text{kV}$	Criterion A
Radio-Frequency, Continuous Radiated Disturbance	IEC 61000-4-3:2020	Criterion A
Electrical Fast Transient (EFT)	IEC 61000-4-4:2012, $\pm 2\text{kV}$	Criterion A
Surge	IEC 61000-4-5:2014+A1:2017, L-N: $\pm 0.5\text{kV}$, $\pm 1\text{kV}$, L-E(Ground): $\pm 0.5\text{kV}$, $\pm 1\text{kV}$, $\pm 2\text{kV}$	Criterion A
Conducted Disturbances, Induced by RF Fields	IEC 61000-4-6:2014+AC:2015	Criterion A
Power Frequency Magnetic Field	IEC 61000-4-8:2010	Criterion A
Voltage Dips	IEC 61000-4-11:2020, Dip: 30% Reduction, Dip >95% Reduction	Criterion A
Voltage Interruptions	IEC 61000-4-11:2020, >95% Reduction	Criterion B
Application Note Link	CFM500M Series App Notes	

CHARACTERISTIC CURVE

Power Derating Curve

Forced Air Flow

Output power & Input voltage

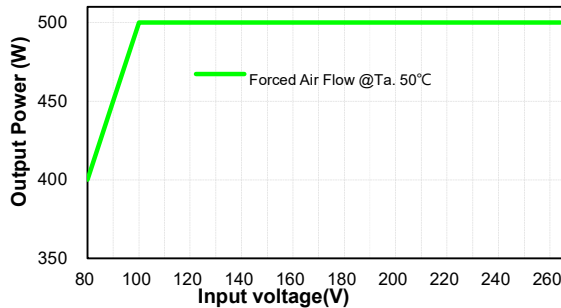

Forced Air Flow

Output power vs Ambient Temperature

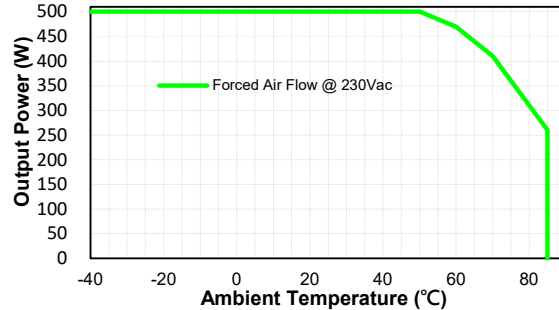

Natural Convection

Output power & Input Voltage

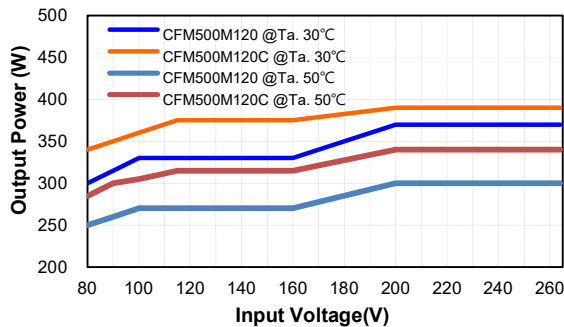

Natural Convection

Output power vs Ambient Temperature

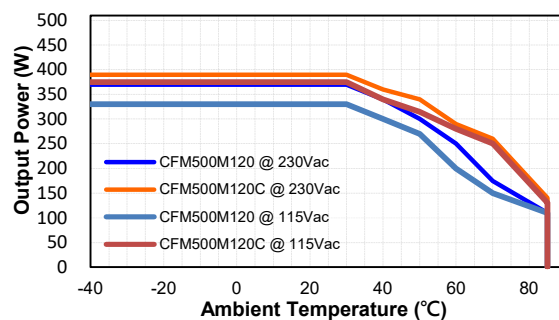



CFM500M Series

Output power & Input Voltage

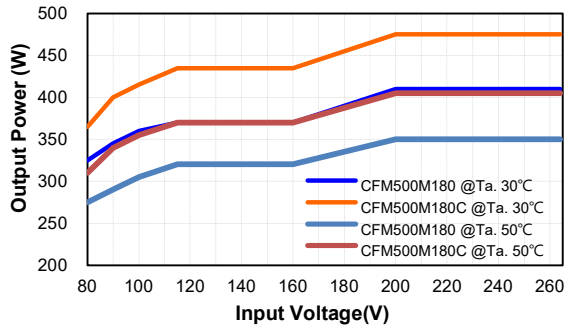

Output power vs Ambient Temperature

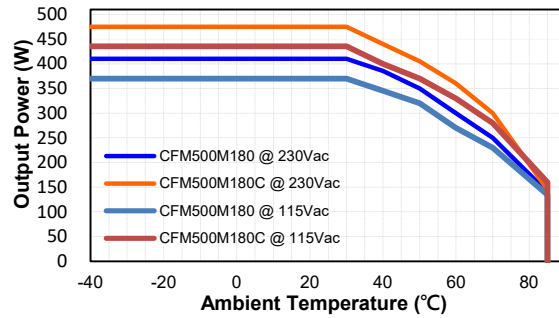

Output power & Input Voltage

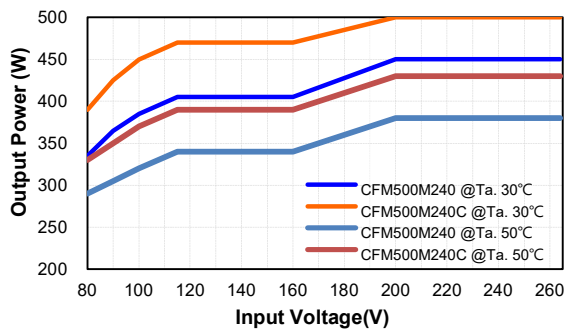

Output power vs Ambient Temperature

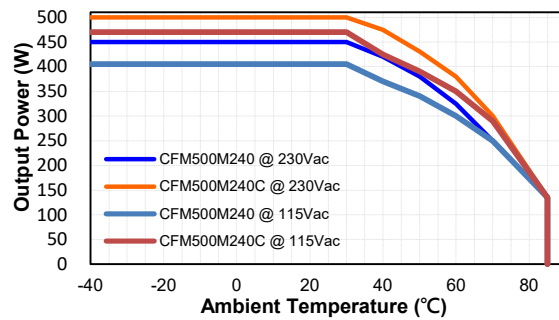

Output power & Input Voltage

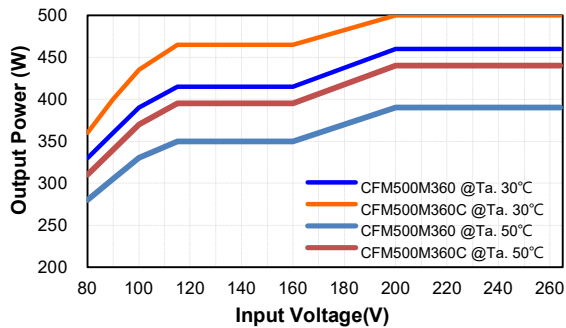

Output power vs Ambient Temperature

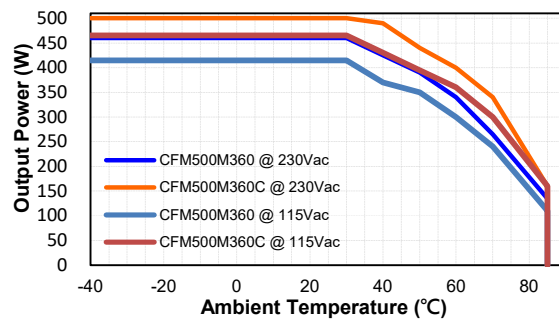

Output power & Input Voltage

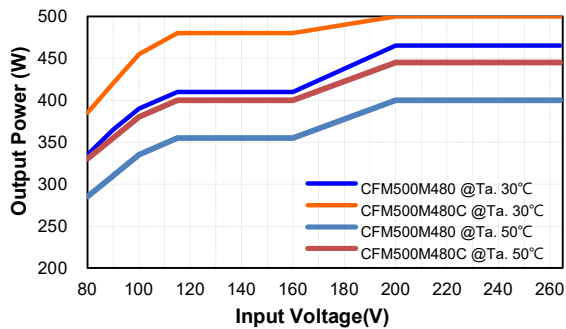

Output power vs Ambient Temperature

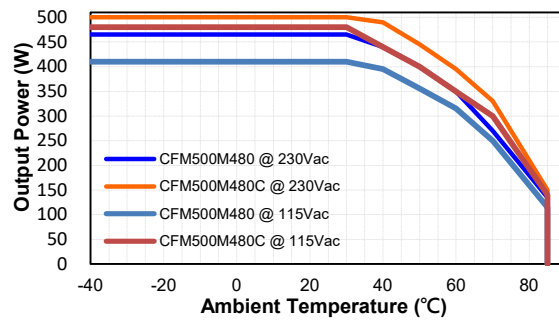



**Conduction Convection with External Baseplate
(48x24.8x0.12cm)**

Output power & Input Voltage

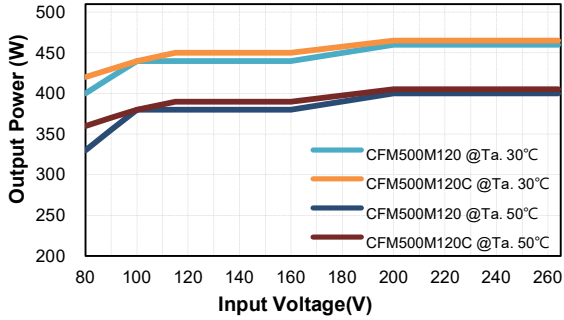

Output power & Input Voltage

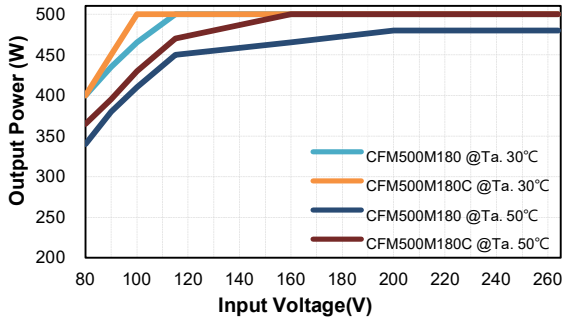

Output power & Input Voltage

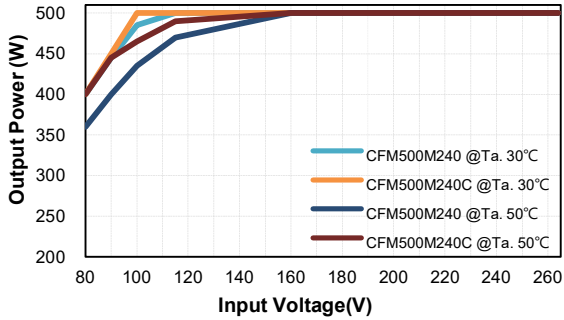

Output power & Input Voltage

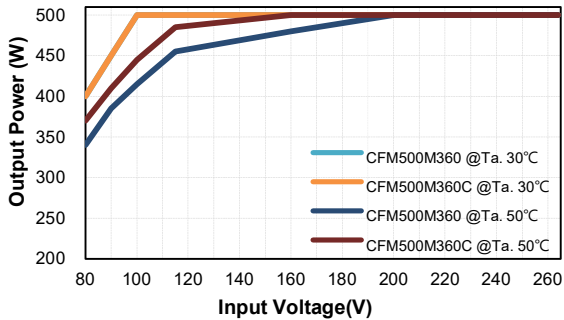

CFM500M Series

**Conduction Convection with External Baseplate
(48x24.8x0.12cm)**

Output power vs Ambient Temperature

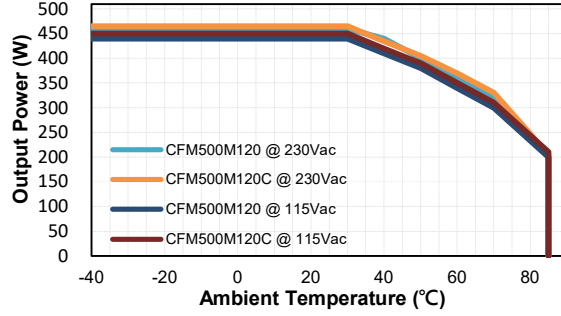

Output power vs Ambient Temperature

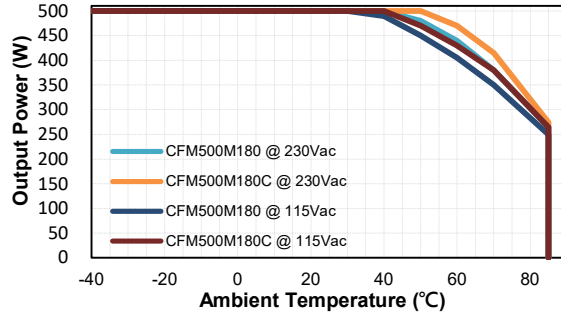

Output power vs Ambient Temperature

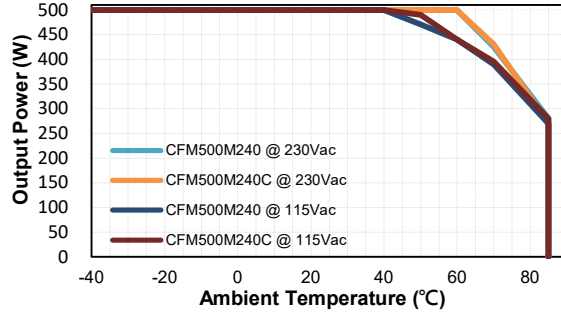

Output power vs Ambient Temperature

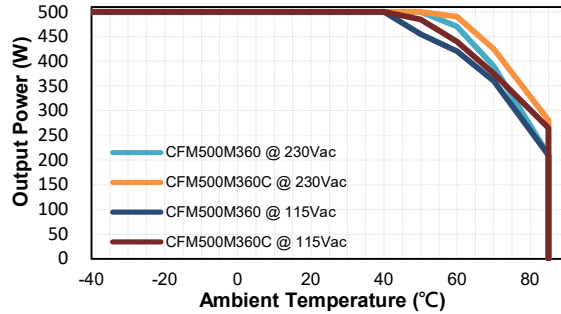



CFM500M Series

Output power & Input Voltage

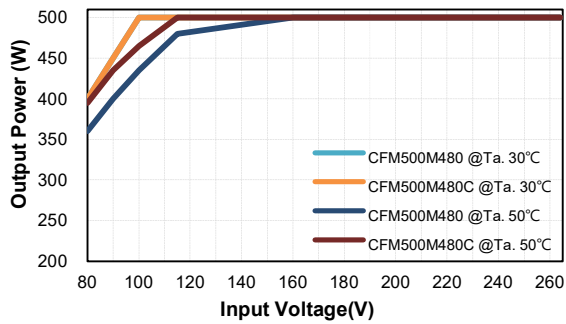

Output power vs Ambient Temperature

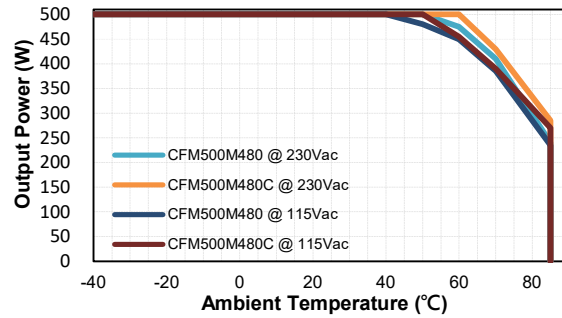

Output Power vs Case Temperature (Tc)

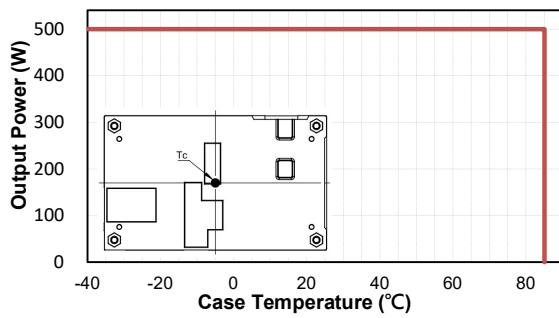

Performance Data

CFM500M120 (Eff Vs Io)

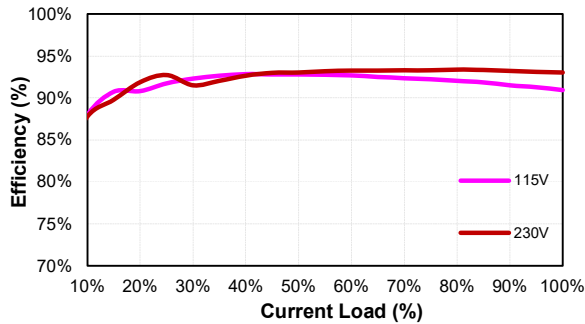

CFM500M180 (Eff Vs Io)

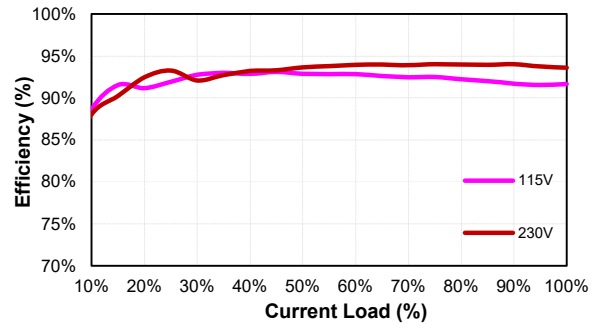

CFM500M240 (Eff Vs Io)

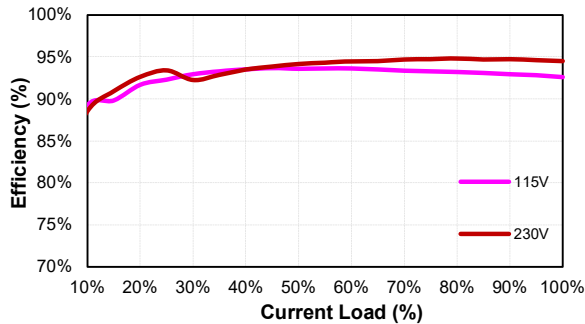

CFM500M360 (Eff Vs Io)

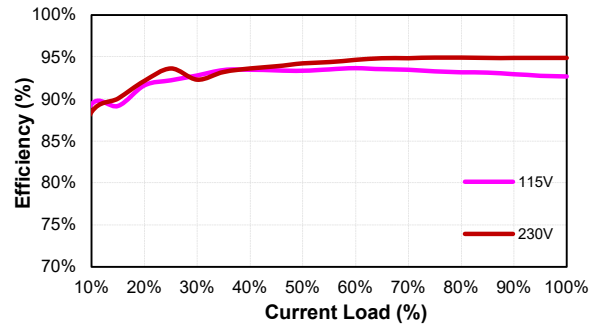



CFM500M Series

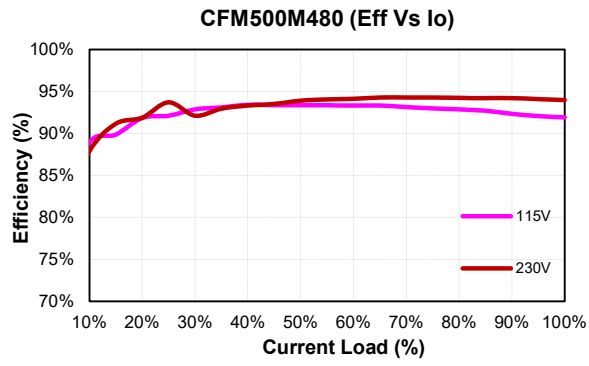



CFM500M Series

MECHANICAL SPECIFICATION

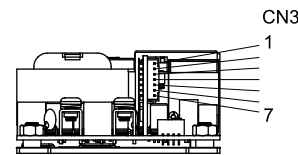
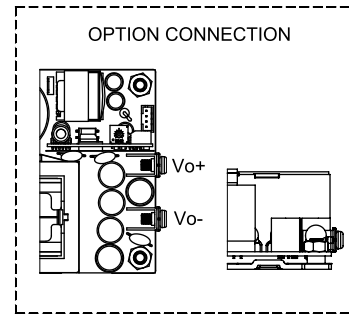
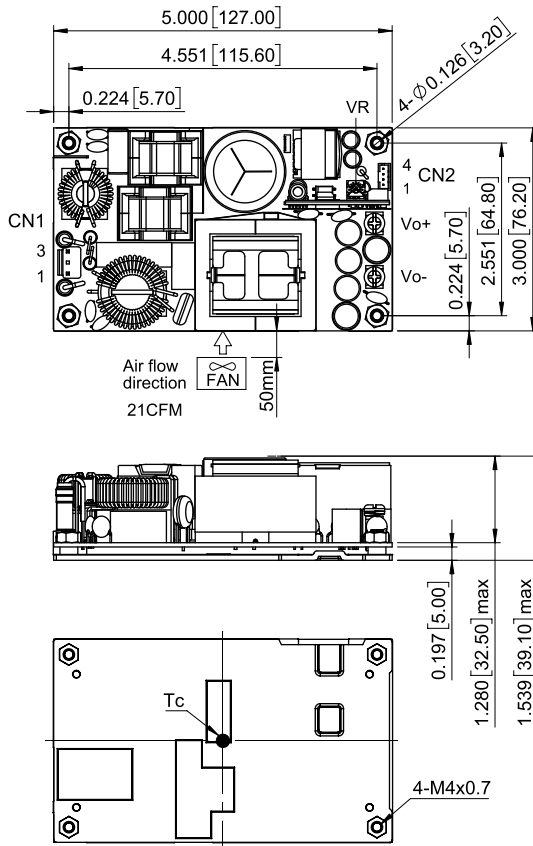

CFM500MXXX

All Dimensions In Inches[mm]
 Tolerance Inches:x.xxx= ± 0.02
 Millimeters: x.xx = ± 0.5

AC Input Connector(CN1):JST B2P3-VH or equivalent

Pin	Function	Mating Housing	Terminal
1	ACL	JST VHR-3N or equivalent	JST SVH-41T-P1.1 or equivalent
2	-		
3	ACN		

DC Output Connector(CN2):TKP P110I-04 or equivalent

Pin	Function	Mating Housing	Terminal
1	GND	JST PHR-4 or equivalent	JST SPH-002T-P0.5L or equivalent
2	+5VSB		
3	GND		
4	+12V-FAN		

DC Output Connector(CN3):TKP P110L-07 or equivalent

Pin	Function	Mating Housing	Terminal
1	GND	JST PHR-7 or equivalent	JST SPH-002T-P0.5L or equivalent
2	PF		
3	FAN-EN		
4	PS-ON		
5	-Sense		
6	+Sense		
7	NA		

DC Output Connector:KANG YANG PCB-58M4 or equivalent

Function	The screw locked torque
Vo-	M4 7kgf-cm
Vo+	



CFM500M Series

MECHANICAL SPECIFICATION

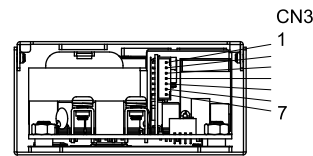
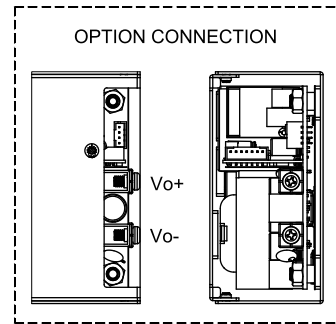
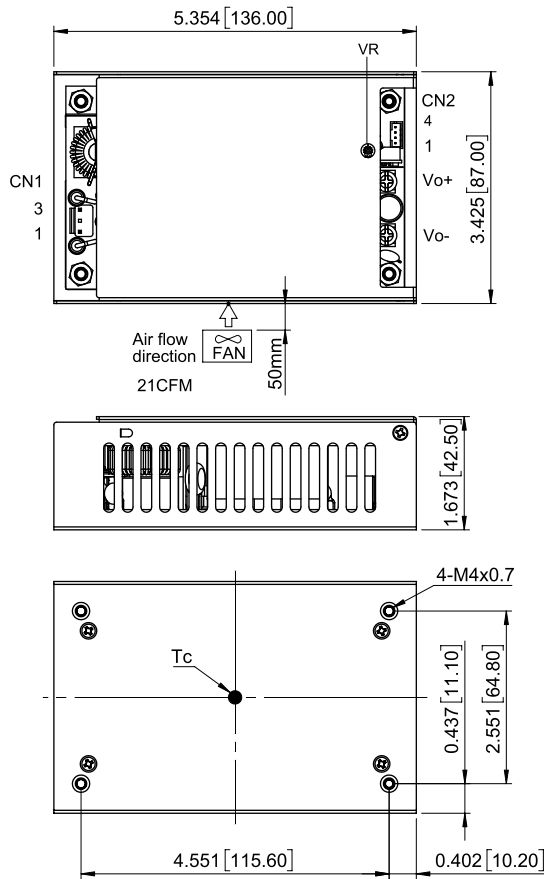

CFM500MXXXC

All Dimensions In Inches[mm]
Tolerance Inches:x.xxx ± 0.02
Millimeters: x.xx ± 0.5

AC Input Connector(CN1):JST B2P3-VH or equivalent

Pin	Function	Mating Housing	Terminal
1	ACL	JST VHR-3N or equivalent	JST SVH-41T-P1.1 or equivalent
2	-		
3	ACN		

DC Output Connector(CN2):TKP P110I-04 or equivalent

Pin	Function	Mating Housing	Terminal
1	GND	JST PHR-4 or equivalent	JST SPH-002T-P0.5L or equivalent
2	+5VSB		
3	GND		
4	+12V-FAN		

DC Output Connector(CN3):TKP P110L-07 or equivalent

Pin	Function	Mating Housing	Terminal
1	GND	JST PHR-7 or equivalent	JST SPH-002T-P0.5L or equivalent
2	PF		
3	FAN-EN		
4	PS-ON		
5	-Sense		
6	+Sense		
7	NA		

DC Output Connector:KANG YANG PCB-58M4 or equivalent

Function	The screw locked torque
Vo-	M4 7kgf-cm
Vo+	

CINCON Electronics Co. Ltd.
Add: 14F, No. 306, Sec.4, Hsin Yi Rd., Taipei, Taiwan
Tel: 886-2-27086210
Fax: 886-2-27029852
E-mail: sales@cincon.com.tw
Web: www.cincon.com