



# CFM400S SERIES 400 WATT AC-DC POWER SUPPLY WITH PFC

## Features

- Universal Input Range 80~264V<sub>ac</sub>
- High Efficiency up to 94%
- 3"x 5" Compact Size
- Class I
- No Load Power Consumption<0.5W (PS-Off)
- Approval IEC/EN/UL 62368-1
- Approval EN 55032, 47 CFR FCC Part 15
- Active PFC Meets EN 61000-3-2
- Meets IEC/EN 60335-1
- High Power Density up to 17.3W/Inch<sup>3</sup>
- 370W Natural, 400W Conduction Convection
- Over Temperature Protection
- PS On/Off Remote Control
- Power Good & Power Fail Signal
- +5V Stand-by, 12V Fan Output
- Low Inrush Current



MODEL NUMBER	OUTPUT VOLTAGE	OUTPUT CURRENT			VOLTAGE ACCURACY	RIPPLE & NOISE	VOLTAGE ADJ. RANGE	LINE REGULATION	LOAD REGULATION	%EFF. (Typ.)
		NOTE1		NOTE2						
		With FAN	Without FAN							
			COVER	OPEN		NOTE3	NOTE4	NOTE5		
CFM400S120	12 V	33.33 A	26.67 A	23.33 A	±1%	120 mV	11.4~12.6 V	±0.5%	±1%	92%
CFM400S180	18 V	22.22 A	17.78 A	15.56 A	±1%	150 mV	17.1~18.9 V	±0.5%	±1%	93%
CFM400S240	24 V	16.67 A	13.33 A	11.67 A	±1%	150 mV	22.8~25.2 V	±0.5%	±1%	94%
CFM400S360	36 V	11.11 A	8.89 A	7.78 A	±1%	200 mV	34.2~37.8 V	±0.5%	±1%	94%
CFM400S480	48 V	8.33 A	6.67A	5.83 A	±1%	250 mV	45.6~50.4 V	±0.5%	±1%	94%
CFM400S540	54 V	7.40 A	5.93 A	5.19 A	±1%	300 mV	51.3~56.7 V	±0.5%	±1%	94%
<b>Stand-by Output Voltage</b>										
All	+5 V	1A (Note 7)			±3%	100 mV	---	±1%	±5%	---
<b>Fan Output Voltage</b>										
All	+12 V	0.5A (Note 6)			---	---	---	---	---	---

Note:

1. V<sub>in</sub>=230V<sub>ac</sub>, Forced air convection with 21.9CFM fan.
2. Voltage accuracy is set at 100% full load and 25°C Ta.
3. Add a 0.1uF ceramic capacitor and a 10uF E.L. capacitor to output for ripple & noise measuring @20MHz BW.
4. Line regulation is measured from high line to low line with 100% full load.
5. Load regulation is measured from 10% to 100% full load.
6. Fan output can only operate normal when the stand-by output is above 0.5A.
7. When PS-OFF, at -40°C, stand-by output voltage with CC load 1A requires input voltage above 100V<sub>ac</sub>.

## PART NUMBER

Series	Number of Outputs	Nominal Output Voltage	Type	Output Terminal
CFM400	X	XXX	X (Option)	-X(Option)
CFM400	S : Single	120 : 12V 180 : 18V 240 : 24V 360 : 36V 480 : 48V 540 : 54V	None : With Baseplate  C : With Cover	None : Vertical  R : Horizontal

Part Number Example:

- CFM400S120:** With Baseplate, 400W, 12Vdc Output, Vertical Type Terminal
- CFM400S120C-R:** With Cover, 400W, 12Vdc Output, Horizontal Type Terminal



# CFM400S Series

## TECHNICAL SPECIFICATIONS

(All specifications are typical at nominal input, full load at 25°C unless otherwise noted.)

### ABSOLUTE MAXIMUM RATINGS

PARAMETER	NOTES and CONDITIONS	Device	Min.	Typ.	Max.	Units
Input Voltage	Safety only 90~264 V <sub>ac</sub>	All	80		264	V <sub>ac</sub>
Operating Temperature	See Derating Curve	All	-40		85	°C
Storage Temperature		All	-40		85	°C
Operating Altitude		All			5000	m

### INPUT CHARACTERISTICS

PARAMETER	NOTES and CONDITIONS	Device	Min.	Typ.	Max.	Units
Operating Voltage Range		All	100		240	V <sub>ac</sub>
Input Frequency Range	Safety 50-60HZ	All	47		63	Hz
Maximum Input Current	100% Full load, V <sub>in</sub> =100V <sub>ac</sub>	All			6	A
Power Factor	V <sub>in</sub> =230V <sub>ac</sub> Full load	All		0.95		
Leakage Current	Contact leakage current Earth leakage current	All			0.1 0.3	mA
Inrush Current	V <sub>in</sub> =240V <sub>ac</sub> , Cold start at 25°C	All		30		A

### OUTPUT CHARACTERISTICS

PARAMETER	NOTES and CONDITIONS	Device	Min.	Typ.	Max.	Units
Output Voltage Set Point	V <sub>in</sub> =Nominal V <sub>in</sub> , I <sub>o</sub> =I <sub>o</sub> max., T <sub>c</sub> =25°C	CFM400S120	11.88	12	12.12	V <sub>dc</sub>
		CFM400S180	17.82	18	18.18	
		CFM400S240	23.76	24	24.24	
		CFM400S360	35.64	36	36.36	
		CFM400S480	47.52	48	48.48	
Operating Output Current Range	V <sub>in</sub> =80V <sub>ac</sub> ~264V <sub>ac</sub> , See Derating Curve	CFM400S120			33.33	A
		CFM400S180			22.22	
		CFM400S240			16.67	
		CFM400S360			11.11	
		CFM400S480			8.33	
CFM400S540			7.40			
Holdup Time	V <sub>in</sub> =115V <sub>ac</sub>	All		10		ms
Output Voltage Regulation						
Load Regulation	10% to 100% full load	All			±1.0	%
Line Regulation	V <sub>in</sub> =High line to low line	All			±0.5	%
Over Voltage Protection	Latch off (AC recycle to reset)	CFM400S120			16	V <sub>dc</sub>
		CFM400S180			30	
		CFM400S240			35	
		CFM400S360			50	
		CFM400S480			63	
CFM400S540			63			
Over Current Protection	Auto recovery	All	110		190	%
Short Circuit Protection	Auto recovery	All				
Over Temperature Protection	Auto recovery	All				



# CFM400S Series

PARAMETER	NOTES and CONDITIONS	Device	Min.	Typ.	Max.	Units
Output Ripple and Noise	1. Add a 0.1uF ceramic capacitor and a 10uF aluminum electrolytic capacitor to output 2. Oscilloscope is 20MHz bandwidth 3. Ambient temperature=25°C	CFM400S120			120	mV
		CFM400S180			150	
		CFM400S240			150	
		CFM400S360			200	
		CFM400S480			250	
		CFM400S540			300	
Load Capacitance	1. $V_{in}=115V_{ac}$ and $230V_{ac}$ 2. Output is 100% full load 3. Ambient temperature=25°C	CFM400S120			33330	uF
		CFM400S180			22220	
		CFM400S240			16670	
		CFM400S360			11110	
		CFM400S480			8330	
		CFM400S540			7400	
Efficiency	1. $V_{in}=230V_{ac}$ 2. Output is 100% full load 3. Ambient temperature=25°C	CFM400S120		92.0		%
		CFM400S180		93.0		
		CFM400S240		94.0		
		CFM400S360		94.0		
		CFM400S480		94.0		
		CFM400S540		94.0		
PS-On Signal	Power on	All	0		2	$V_{dc}$
	Power off (PS-ON and GND open)			4		mA
	Power on (PS-ON and GND short)			10		
	Power-off (PS-ON and GND open)			0		
Power Good (PG)	1. $V_{in}=80V_{ac}\sim 264V_{ac}$ 2. Output is 100% full load 3. The TTL goes high after power set up	All	100		500	ms
Power Fail (PF)	1. $V_{in}=80V_{ac}\sim 264V_{ac}$ 2. Output is 100% full load 3. The TTL goes low before $V_o$ below 90% rated value	All	1	10		ms

## ISOLATION CHARACTERISTICS

PARAMETER	NOTES and CONDITIONS	Device	Min.	Typ.	Max.	Units
Input to Output	1 minute	All	3000		4000	$V_{ac}$
Isolation Resistance	Input to output	All	100			MΩ

## FEATURE CHARACTERISTICS

PARAMETER	NOTES and CONDITIONS	Device	Min.	Typ.	Max.	Units
Switching Frequency	$P_{out}=\text{max. rated power}$	All		65		kHz
Output Voltage adjustment		All	-5		+5	%

## GENERAL SPECIFICATIONS

PARAMETER	NOTES and CONDITIONS	Device	Min.	Typ.	Max.	Units
MTBF	$I_o=100\%$ ; $T_a=25^\circ\text{C}$ per MIL-HDBK-217F	All		300		k hours
Humidity	Non-condensing	All			93	% RH
Shock	Meet MIL-STD-810F Table 516.5, Table 516.5-I 10ms, each axis 3 times ( $\pm X$ 、 $\pm Y$ 、 $\pm Z$ axis)	All		75		g
Vibration	Meet MIL-STD-810F Table 514.5C-VIII, 15~2000Hz, X、Y、Z axis, 1 hour (each axis), Total 3 hrs.	All		4		g



# CFM400S Series

## GENERAL SPECIFICATIONS

PARAMETER	NOTES and CONDITIONS	Device	Min.	Typ.	Max.	Units
Weight	Baseplate versions Covered versions	All		470 550		g
Dimensions	With baseplate C (with cover)	All	5.000x3.000x1.540 Inches (127.00x76.20x39.10 mm) 5.354x3.425x1.673 Inches (136.00x87.00x42.50 mm)			
<b>Safety</b>	Class I, EN/IEC/UL 62368-1					Ed3.0
<b>EMC Emission</b>	EN 55032:2015+A11:2020, EN 61000-6-3 2007+A1: 2011+AC: 2012, Class B EN IEC 61000-6-4:2019, 47 CFR FCC Part 15 Subpart B (Class B) EN IEC 61204-3:2018, EN IEC 61000-3-2:2019, EN 61000-3-3:2013+A1:2019					
Conducted Disturbance	EN 55032:2015+A11:2020, EN 61000-6-3 2007+A1: 2011+AC: 2012, Class B EN IEC 61000-6-4:2019, 47 CFR FCC Part 15 Subpart B (Class B), EN IEC 61204-3:2018					Class B
Radiated Disturbance	EN 55032:2015+A11:2020, EN 61000-6-3 2007+A1: 2011+AC: 2012, Class B EN IEC 61000-6-4:2019, 47 CFR FCC Part 15 Subpart B (Class B), EN IEC 61204-3:2018					Class B
Harmonic Current Emissions	EN IEC 61000-3-2:2019					Class A, C
Voltage Fluctuations & Flicker	EN 61000-3-3:2013+A1:2019					
<b>EMC Immunity</b>	EN 55035:2017+A11:2020, EN IEC 61000-6-1:2019, EN IEC 61000-6-2:2019 EN IEC 61204-3:2018, IEC 61000-4-2, 3, 4, 5, 6, 8, 11					
Electrostatic Discharge (ESD)	IEC 61000-4-2:2008, Air Discharge: $\pm 8$ kV, Contact Discharge: $\pm 4$ kV					Criterion A
Radio-Frequency, Continuous Radiated Disturbance	IEC 61000-4-3:2020					Criterion A
Electrical Fast Transient (EFT)	IEC 61000-4-4:2012, $\pm 1$ kV, $\pm 2$ kV					Criterion A
Surge	IEC 61000-4-5:2014+A1:2017, L-N: $\pm 0.5$ kV, $\pm 1$ kV, L-E(Ground): $\pm 0.5$ kV, $\pm 1$ kV, $\pm 2$ kV					Criterion A
Conducted Disturbances, Induced by RF Fields	IEC 61000-4-6:2013+COR1:2015					Criterion A
Power Frequency Magnetic Field	IEC 61000-4-8:2009					Criterion A
Voltage Dips	IEC 61000-4-11:2020, Dip: 30% Reduction, Dip >95% Reduction					Criterion A
Voltage Interruptions	IEC 61000-4-11:2020, >95% Reduction					Criterion B
Application Note Link	<a href="#">CFM400S Series App Notes</a>					



## CHARACTERISTIC CURVE

### Power Derating Curve

#### Forced Air Flow

Output power & Input voltage

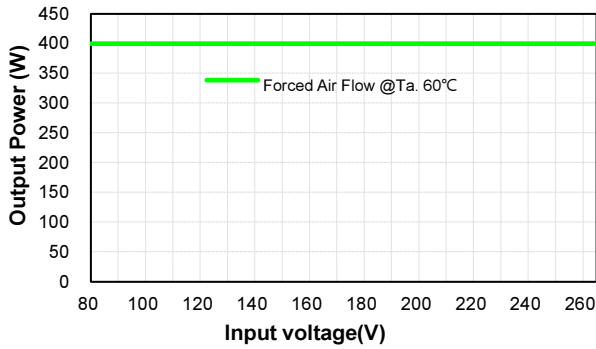

#### Forced Air Flow

Output power vs Ambient Temperature

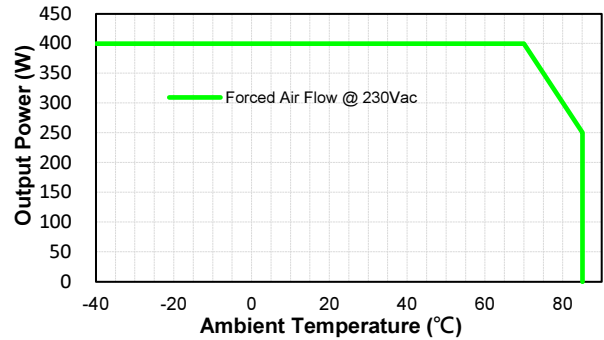

#### Natural Convection

Output power & Input Voltage

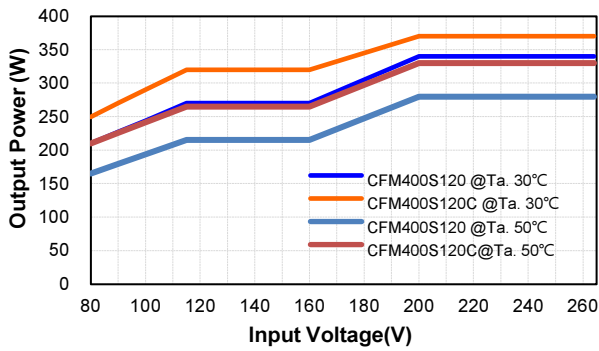

#### Natural Convection

Output power vs Ambient Temperature

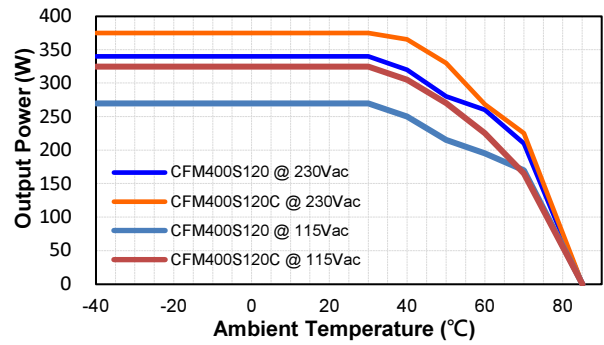

Output power & Input Voltage

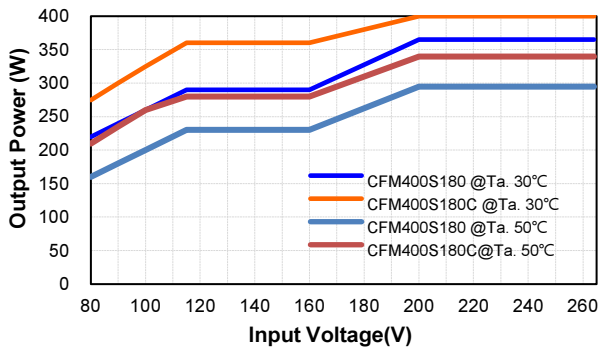

Output power vs Ambient Temperature

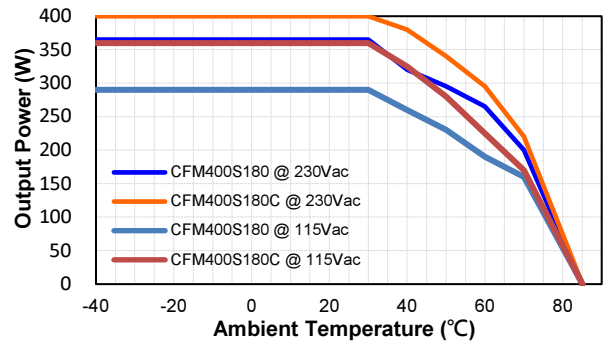



# CFM400S Series

Output power & Input Voltage

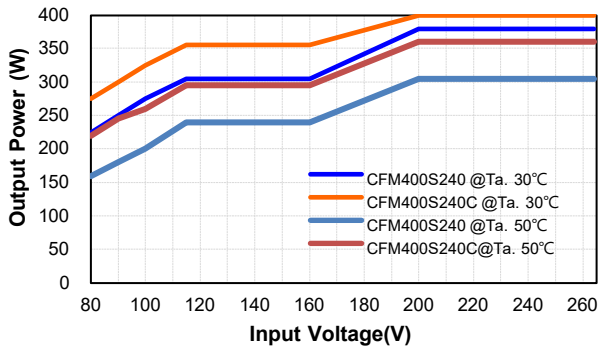

Output power vs Ambient Temperature

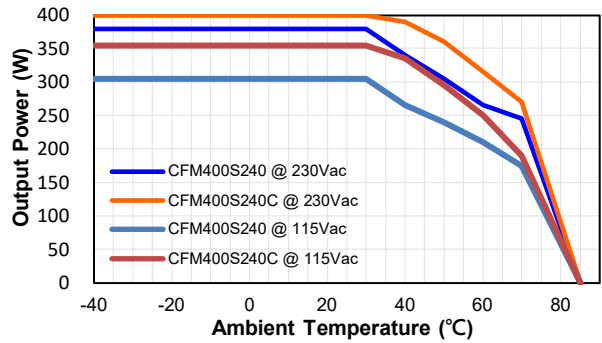

Output power & Input Voltage

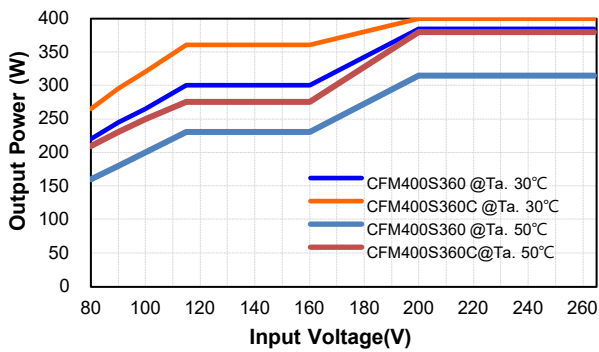

Output power vs Ambient Temperature

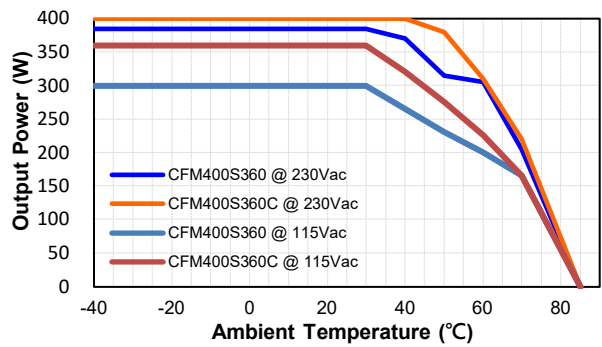

Output power & Input Voltage

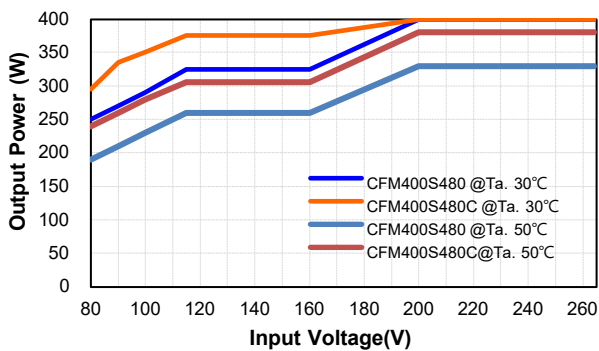

Output power vs Ambient Temperature

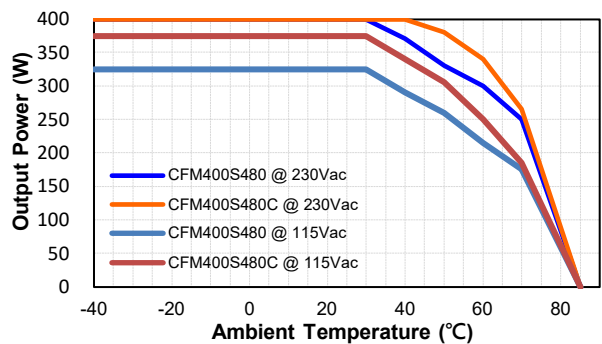

Output power & Input Voltage

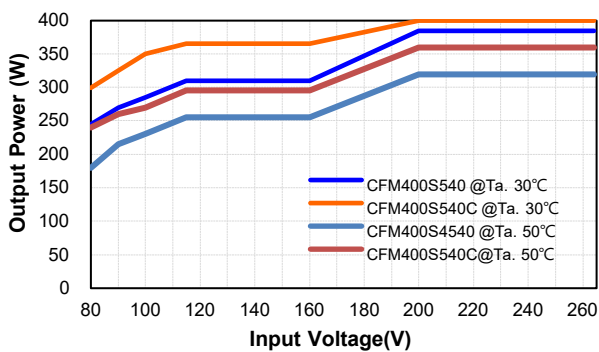

Output power vs Ambient Temperature

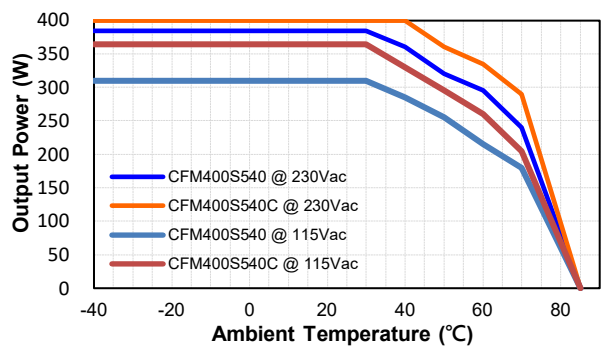



**Conduction Convection with External Baseplate  
(48x24.8x0.12cm)**

**CFM400S Series**

**Conduction Convection with External Baseplate  
(48x24.8x0.12cm)**

**Output power & Input Voltage**

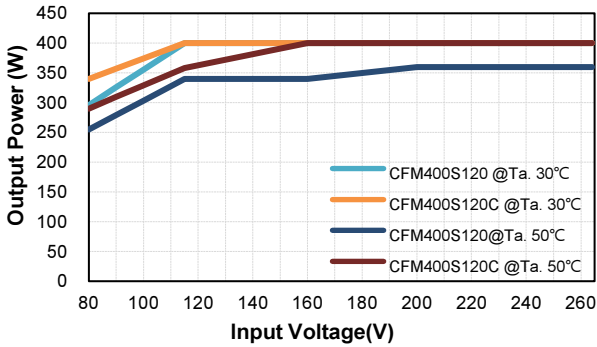

**Output power vs Ambient Temperature**

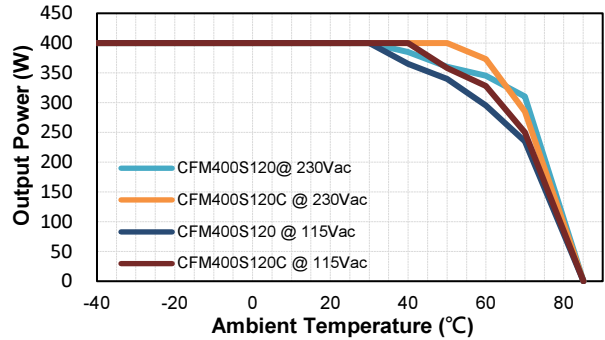

**Output power & Input Voltage**

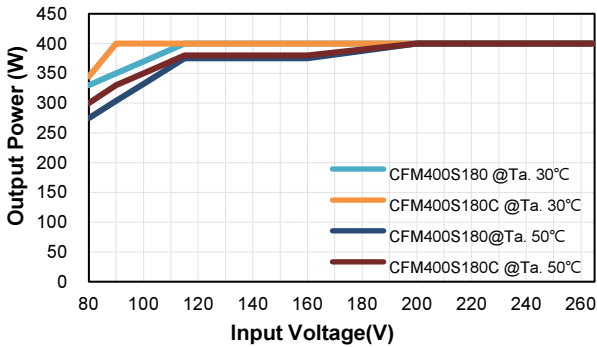

**Output power vs Ambient Temperature**

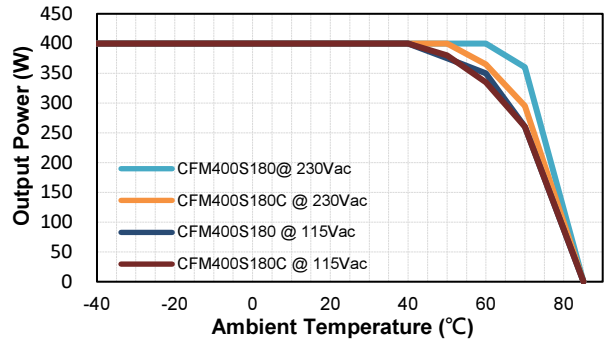

**Output power & Input Voltage**

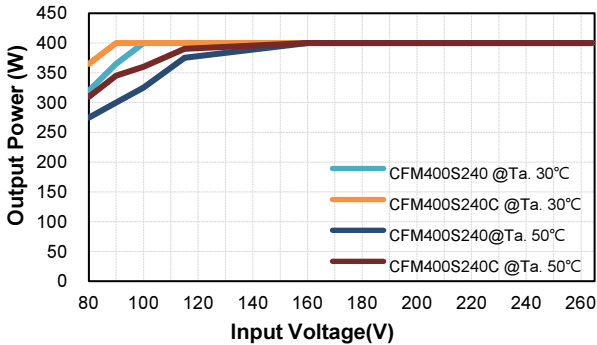

**Output power vs Ambient Temperature**

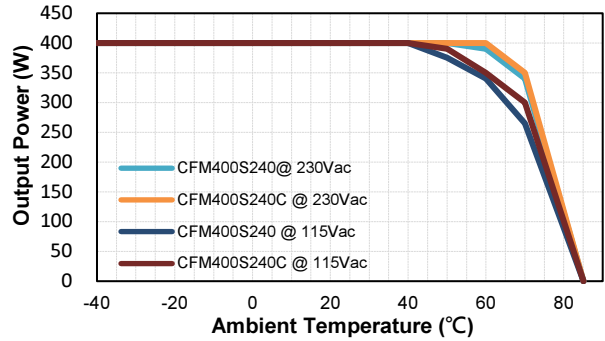

**Output power & Input Voltage**

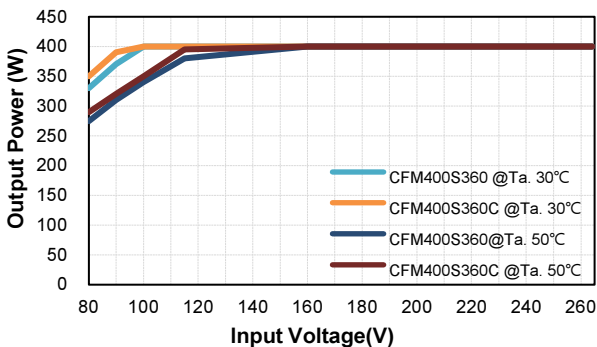

**Output power vs Ambient Temperature**

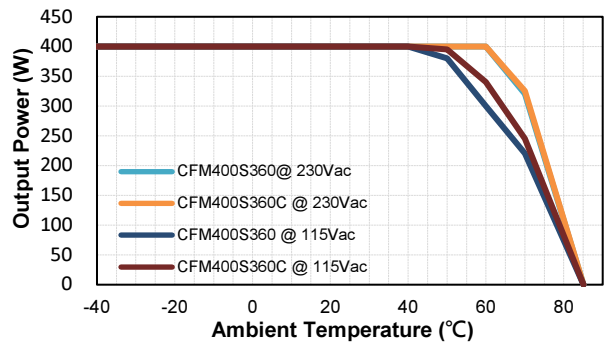



# CFM400S Series

Output power & Input Voltage

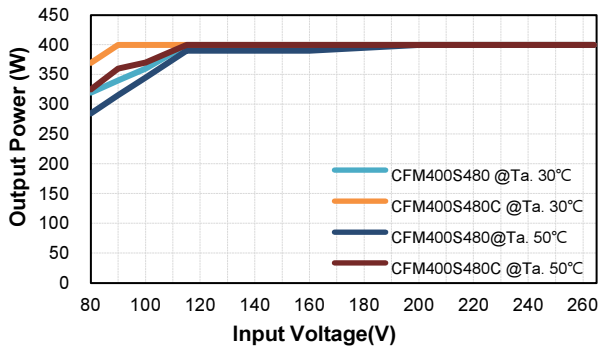

Output power vs Ambient Temperature

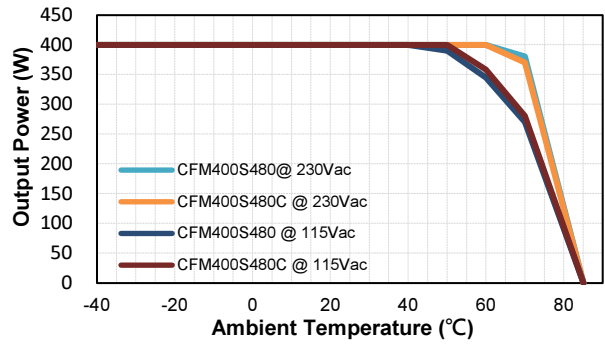

Output power & Input Voltage

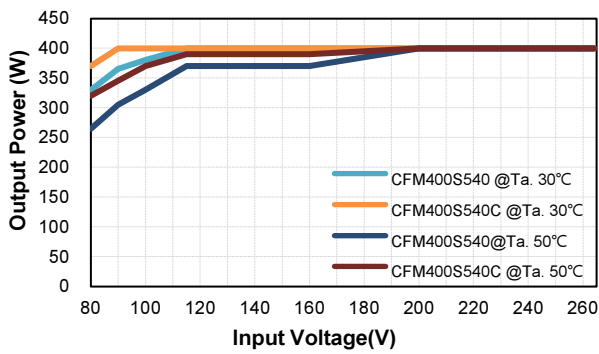

Output power vs Ambient Temperature

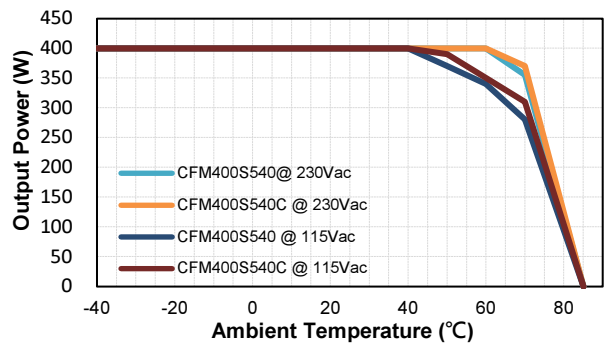

## Performance Data

CFM400S120 (Eff Vs Io)

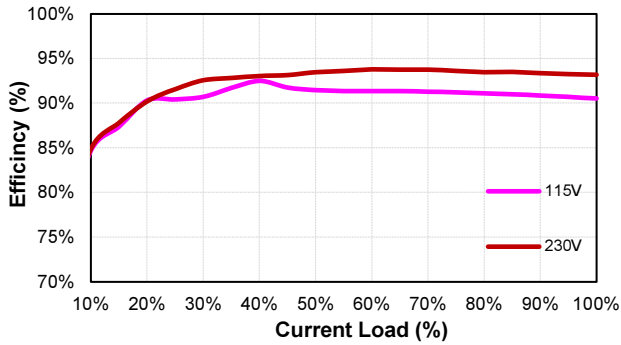

CFM400S180 (Eff Vs Io)

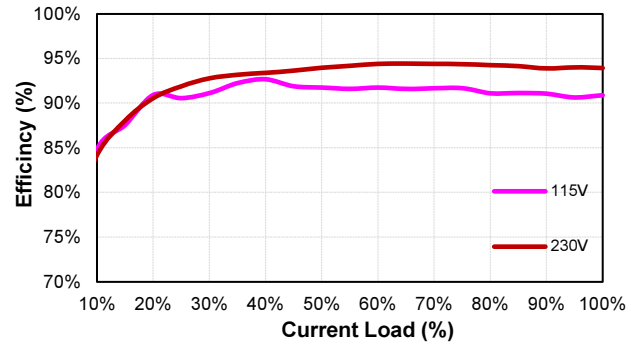

CFM400S240 (Eff Vs Io)

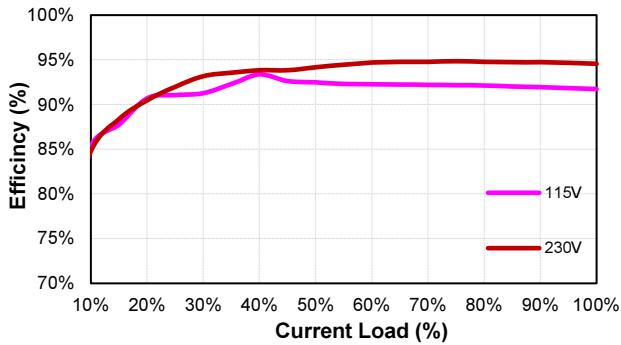

CFM400S360 (Eff Vs Io)

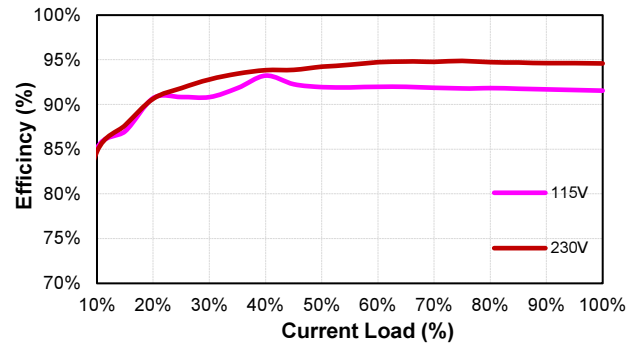





# CFM400S Series

CFM400S480 (Eff Vs Io)

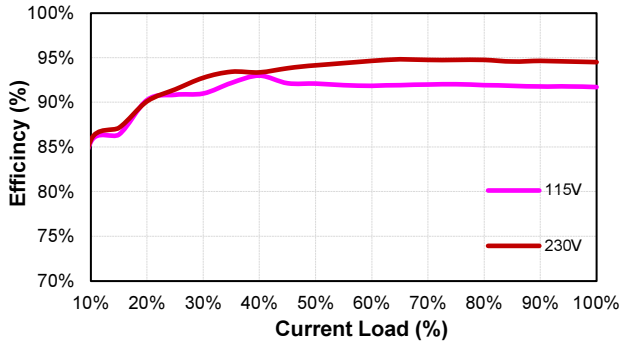

CFM400S540 (Eff Vs Io)

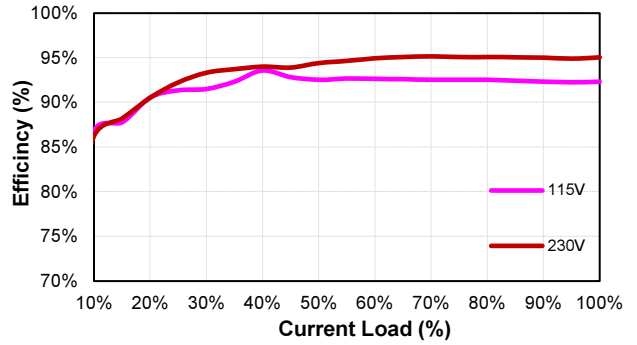

## MECHANICAL SPECIFICATION

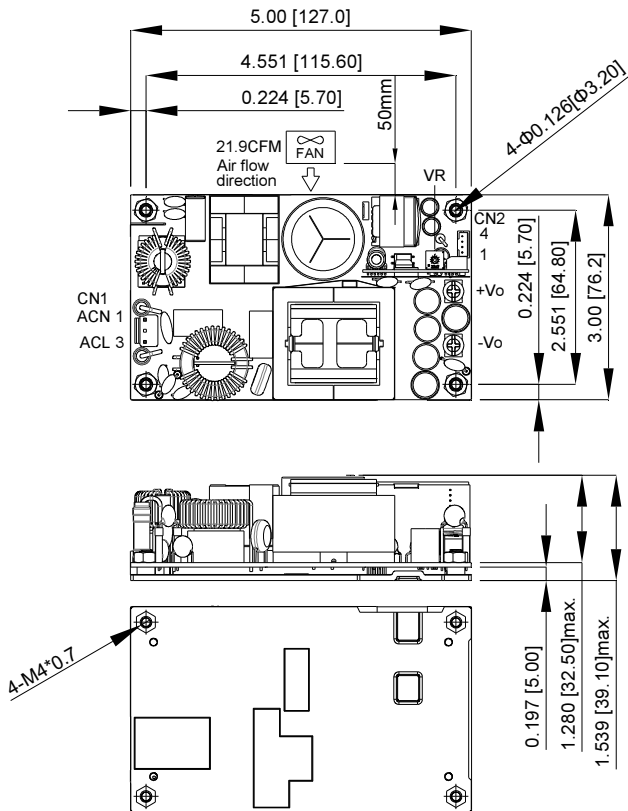

## CFM400SXXX

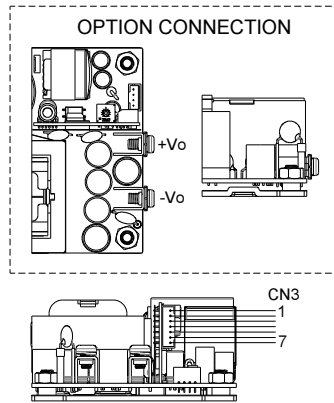

PIN CONNECTION		
PIN	Function	Wafer
1	ACN	CN1
2	-	
3	ACL	CN2
1	GND	
2	+5VSB	
3	GND	CN3
4	+12V-FAN	
1	GND	
2	PF	
3	FAN-EN	
4	PS-ON	
5	-Sense	
6	+Sense	
7	OPTION	

All Dimensions In Inches[mm]  
 Tolerance Inches: x.xx = ± 0.03, x.xxx = ± 0.02  
 Millimeters: x.x = ± 0.7, x.xx = ± 0.5



# CFM400S Series

## MECHANICAL SPECIFICATION

### CFM400SXXXC

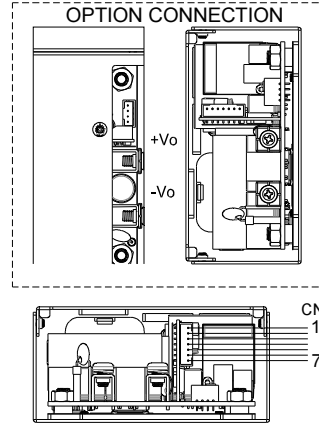
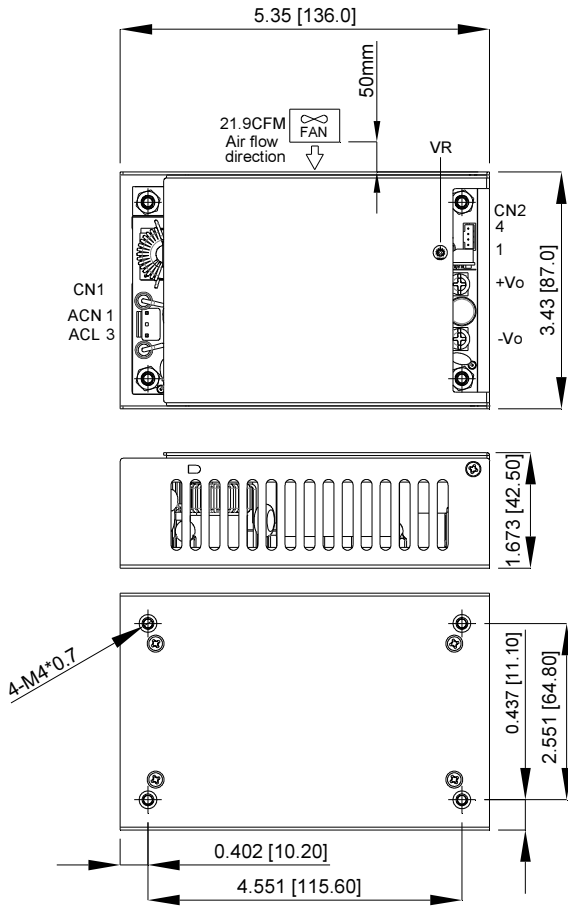

PIN CONNECTION		
PIN	Function	Wafer
1	ACN	CN1
2	-	
3	ACL	CN2
1	GND	
2	+5VSB	
3	GND	
4	+12V-FAN	CN3
1	GND	
2	PF	
3	FAN-EN	
4	PS-ON	
5	-Sense	
6	+Sense	
7	OPTION	

All Dimensions In Inches[mm]  
Tolerance Inches: x.xx = ± 0.03, x.xxx = ± 0.02  
Millimeters: x.x = ± 0.7, x.xx = ± 0.5

CINCON Electronics Co. Ltd.  
Add: 14F, No. 306, Sec.4, Hsin Yi Rd., Taipei, Taiwan  
Tel: 886-2-27086210  
Fax: 886-2-27029852  
E-mail: [sales@cincon.com.tw](mailto:sales@cincon.com.tw)  
Web: [www.cincon.com](http://www.cincon.com)