

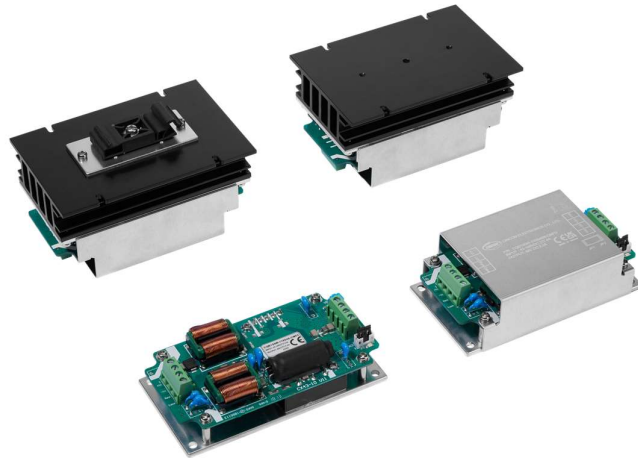

# CQB150W-110S CMFC(D)Series Application Note V13

## ISOLATED DC-DC CONVERTER CHASSIS MOUNT CQB150W-110SXX-CMFC(D) SERIES APPLICATION NOTE



### Approved By:

Department	Approved By	Checked By	Written By
Research and Development Department	Jacky	Astray	Jiawei
Design Quality Department	Benny	JoJo	



# CQB150W-110S CMFC(D)Series

## Application Note V13

---

### Contents

1. Introduction .....	3
2. Pin Function Description .....	3
3. Terminal Block .....	3
4. Connection for Standard Use .....	4
5. Test Set-Up .....	4
6. Features and Functions .....	4
6.1 UVLO (Under Voltage Lock Out) .....	4
6.2 Over Current/Short Circuit Protection .....	4
6.3 Output Over Voltage Protection .....	5
6.4 Over Temperature Protection .....	5
6.5 Remote On/Off .....	5
6.6 Output Remote Sensing .....	6
6.7 Output Voltage Adjustment .....	6
7. Input / Output Considerations .....	7
7.1 Hold Up Time .....	7
7.2 Output Ripple and Noise .....	7
7.3 Output Capacitance .....	7
8. Series and Parallel Operation .....	8
8.1 Series Operation .....	8
8.2 Parallel Operation .....	8
8.3 Redundant Operation .....	8
9. Thermal Design .....	9
9.1 Operating Temperature Range .....	9
9.2 Convection Requirements for Cooling .....	9
9.3 Thermal Considerations .....	9
9.4 Power Derating .....	9
9.5 Heat Sinks .....	13
10. Safety & EMC .....	14
10.1 Input Fusing and Safety Considerations .....	14
10.2 EMC Considerations .....	14



# CQB150W-110S CMFC(D)Series Application Note V13

## 1. Introduction

The CQB150W-110SXX-CMFC(D) series of DC-DC converters offers 150 watts of output power @ single output voltages of 3V3, 5, 12, 15, 24,28, 48VDC with industry standard quarter-brick. It has a wide (4:1) input voltage range of 43 to 160VDC (110VDC nominal) and 3000VDC basic isolation.

High efficiency up to 91%, allowing case operating temperature range of -40°C to 100°C. An optional heat sink is available to extend the full power range of the unit. Very low no load power consumption (15mA), an ideal solution for energy critical systems.

The standard control functions include remote on/off (positive or negative) and +10%, -10% adjustable output voltage.

Fully protected against input UVLO (under voltage lock out), output over-current, output over-voltage and over-temperature and continuous short circuit conditions.

CQB150W-110SXX-CMFC(D) series is highly suitable for distributed power architectures, telecommunications, servers, base station, battery operated equipment, and industrial applications.

## 2. Pin Function Description

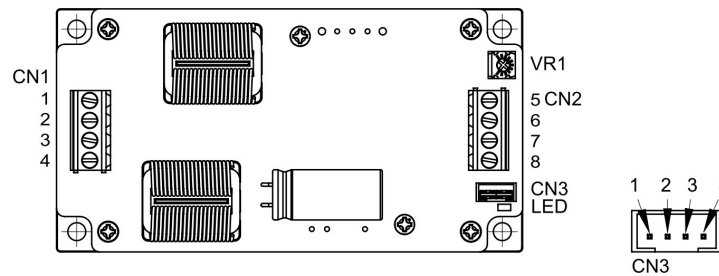

No	CN1&CN2	Description	Reference
1	+V Input	Positive Supply Input	<b>Section 7.1</b>
2	-V Input	Negative Supply Input	<b>Section 7.1</b>
3	Remote	External Remote On/Off Control	<b>Section 6.5</b>
4	Case	Connected to Base Plate	
5	+V Output	Positive Power Output	<b>Section 7.2/7.3</b>
6	+V Output	Positive Power Output	<b>Section 7.2/7.3</b>
7	-V Output	Negative Power Output	<b>Section 7.2/7.3</b>
8	-V Output	Negative Power Output	<b>Section 7.2/7.3</b>
--	--	Clear Mounting Insert (FG)	<b>Section 9.5</b>

No	CN3	Description	Reference
1	-V Output	Negative Power Output	<b>Section 7.2/7.3</b>
2	-Sense	Negative Output Remote Sense	<b>Section 6.6</b>
3	+Sense	Positive Output Remote Sense	<b>Section 6.6</b>
4	+V Output	Positive Power Output	<b>Section 7.2/7.3</b>

Note: Base plate can be connected to FG through Ø4.5 mounting insert. Recommended torque 9.6~12.8Kgf-cm.

## 3. Terminal Block

Input and Output Terminal Block

Terminal Type	Screw Torque Value (Kgf-cm)	Suitable Electric Wire (AWG)	Current Rating (max.)
EK500V-04P or Equivalent	5	12-24	20A



# CQB150W-110S CMFC(D)Series Application Note V13

## 4. Connection for Standard Use

The connection for standard use is shown below. An external output capacitors (C1) is recommended to reduce output ripple and noise, output capacitor recommended 1uF ceramic capacitor for all models.

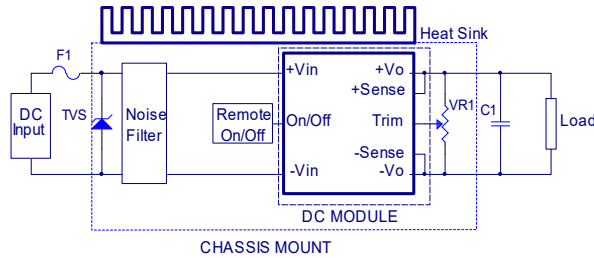

Symbol	Component	Reference
F1, TVS	Input fuse, TVS	<b>Section 10.1</b>
Noise Filter	Internal input noise filter	<b>Section 10.2</b>
Remote On/Off	External Remote On/Off control	<b>Section 6.5</b>
Trim	Internal output voltage adjustment by variable resistor	<b>Section 6.7</b>
Heat sink	External heat sink	<b>Section 9.4/9.5</b>
+Sense/-Sense	--	<b>Section 6.6</b>

## 5. Test Set-Up

The basic test set-up to measure parameters such as efficiency and load regulation is shown below. When testing the modules under any transient conditions please ensure that the transient response of the source is sufficient to power the equipment under test. We can calculate:

- Efficiency
- Load regulation and line regulation

The value of efficiency is defined as:

$$\eta = \frac{V_o \times I_o}{V_{in} \times I_{in}} \times 100\%$$

Where:

- $V_o$  is output voltage,
- $I_o$  is output current,
- $V_{in}$  is input voltage,
- $I_{in}$  is input current.

The value of load regulation is defined as:

$$Load\ reg. = \frac{V_{FL} - V_{NL}}{V_{NL}} \times 100\%$$

Where:

$V_{FL}$  is the output voltage at full load.

$V_{NL}$  is the output voltage at no load.

The value of line regulation is defined as:

$$Line\ reg. = \frac{V_{HL} - V_{LL}}{V_{LL}} \times 100\%$$

Where:

$V_{HL}$  is the output voltage of maximum input voltage at full load.

$V_{LL}$  is the output voltage of minimum input voltage at full load.

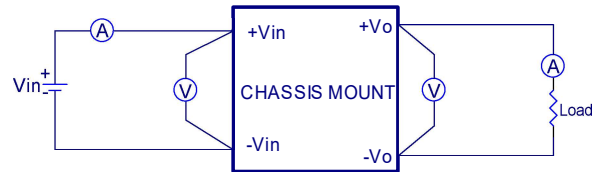

CQB150W-110SXX-CMFC(D) Series Test Setup

## 6. Features and Functions

### 6.1 UVLO (Under Voltage Lock Out)

Input under voltage lockout is standard on the CQB150W-110SXX-CMFC(D) series unit. The unit will shut down when the input voltage drops below a threshold, and the unit will operate when the input voltage goes above the upper threshold.

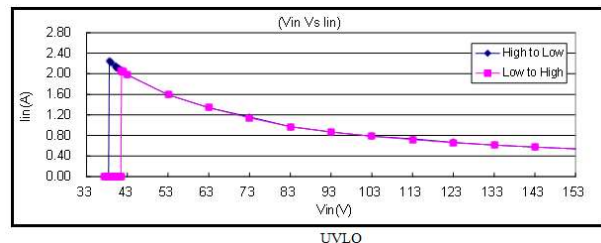

### 6.2 Over Current/Short Circuit Protection

All models have internal over current and continuous short circuit protection. The unit operates normally once the fault condition is removed. At the point of current limit inception, the converter will go into hiccup mode protection.



# CQB150W-110S CMFC(D)Series Application Note V13

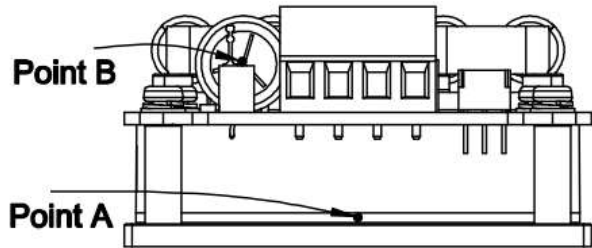
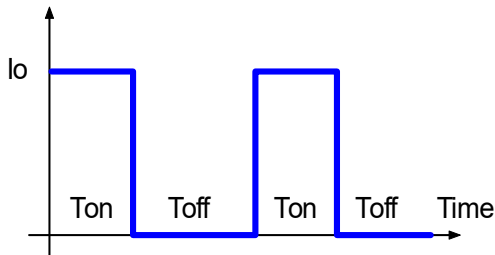
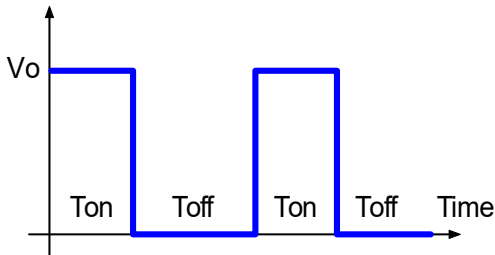

### 6.3 Output Over Voltage Protection

The output over voltage protection consists of circuitry that internally limits the output voltage. If more accurate output over voltage protection is required, then an external circuit can be used via the remote on/off pin.

**Note:** Please note that device inside the power supply might fail when voltage more than rate output voltage is applied to output pin. This could happen when the customer tests the over voltage protection of unit.

### 6.4 Over Temperature Protection

These modules have an over temperature protection circuit to safeguard against thermal damage. Shutdown occurs with the maximum case reference temperature is exceeded. The module will restart when the case temperature falls below over temperature recovery threshold. Please measured at point A (measuring point A refer to the following figure).

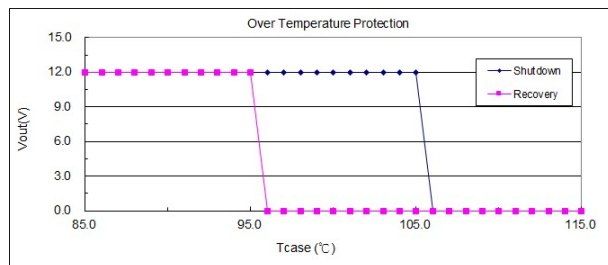

### 6.5 Remote On/Off

The CQB150W-110SXX-CMFC(D) series allows the user to switch the module on and off electronically with the remote on/off feature. All models are available in "positive logic" and "negative logic" (optional) versions. The converter turns on if the remote on/off pin is high (>3.5Vdc to 160Vdc or open circuit). Setting the pin low (0 to <1.2Vdc) will turn the converter off. The signal level of the remote on/off input is defined with respect to ground. If leave the remote on/off pin open, the converter will be off.

Models with part number suffix "N" are the "negative logic" remote on/off version. The unit turns off if the remote on/off pin is high (>3.5Vdc to 160Vdc or open circuit). The converter turns on if the on/off pin input is low (0 to <1.2Vdc). Note that the converter is on by default.

Logic State (CN1 Pin 3)	Negative Logic	Positive Logic
Logic Low – 0 to 1.2Vdc	Module On	Module Off
Logic High – 3.5 to 160Vdc or Open circuit	Module Off	Module On

Avoid the reverse polarity input voltage. It may break the power supply connection examples see below.

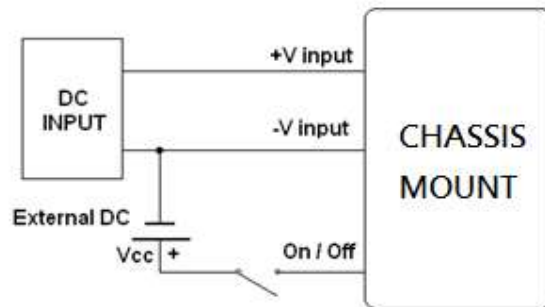

Remote On/Off Connection Example



# CQB150W-110S CMFC(D)Series

## Application Note V13

### 6.6 Output Remote Sensing

The CQB150W-110SXX-CMFC(D) series converter has the capability to remotely sense both lines of its output. This feature moves the effective output voltage regulation point from the output of the unit to the point of connection of the remote sense pins. This feature automatically adjusts the real output voltage of the CQB150W-110SXX-CMFC(D) series in order to compensate for voltage drops in distribution and maintain a regulated voltage at the point of load. The remote-sense voltage range is:

$$[(+V_{out}) - (-V_{out})] - [(+Sense) - (-Sense)] \leq 10\% \text{ of } V_{o\_nominal}$$

When remote sensing is used, please remove the jumper of CN3 and the sense should be connected by twisted-pair wire or shield wire. If the sensing patterns short, heavy current flows and the pattern may be damaged. Output voltage might become unstable because of impedance of wiring and load condition when length of wire is exceeding 400mm. This is shown in the schematic below.

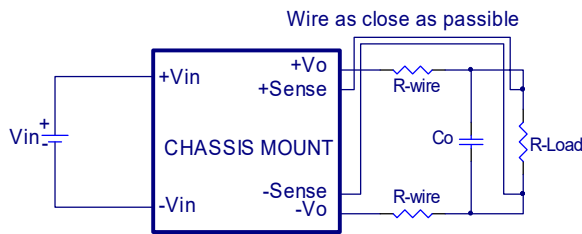

When the CMFC module are shipped from a factory, they come with a dedicated jumper being mounted on CN3. If the remote sense feature is not to be used, the sense pins should be connected locally. The +Sense pin should be connected to the +Vout pin at the module and the -Sense pin should be connected to the -Vout pin at the module. Wire between +Sense and +Vout and between -Sense and -Vout as short as possible. Loop wiring should be avoided. The converter might become unstable by noise coming from poor wiring. This is shown in the schematic below.

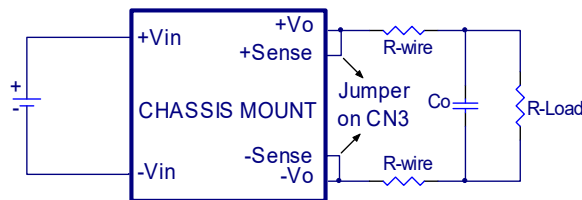

### Note:

Although the output voltage can be varied (increased or decreased) by both remote sense and trim, the maximum variation for the output voltage is the larger of the two values not the sum of the values. The output power delivered by the module is defined as the voltage at the output terminals multiplied by the output current. Using remote sense and trim can cause the output voltage to increase and consequently increase the power output of the module if output current remains unchanged. Always ensure that the output power of the module remains at or below the maximum rated power. Also be aware that if  $V_{o,set}$  is below nominal value,  $P_{out,max}$  will also decrease accordingly because  $I_{o,max}$  is an absolute limit. Thus,  $P_{out,max} = V_{o,set} \times I_{o,max}$  is also an absolute limit.

### 6.7 Output Voltage Adjustment

Output voltage can be adjusted by internal variable resistor (adjustment range: +10% to -10%). Turning internal variable resistor clockwise reduces the output voltage and counterclockwise increases the output voltage.

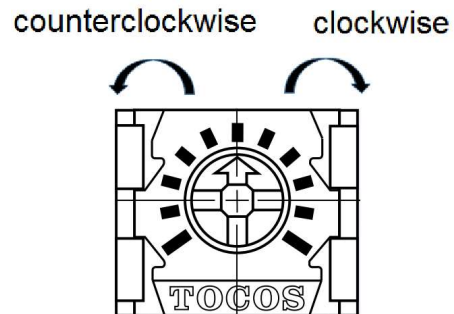



# CQB150W-110S CMFC(D)Series Application Note V13

## 7. Input / Output Considerations

### 7.1 Hold Up Time

Hold up time is defined as the duration of time that DC/DC converter output will remain active following a loss of input power.

The test condition and test curve refer to following figures.

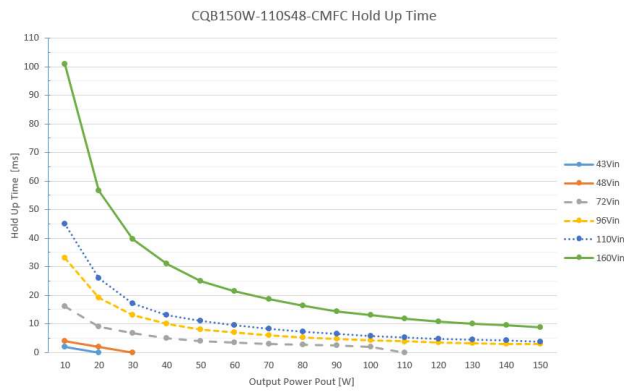
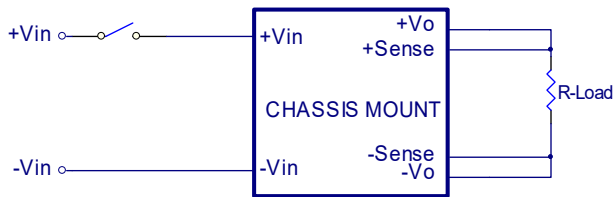

The external circuit about extend hold up time refer to following figure.

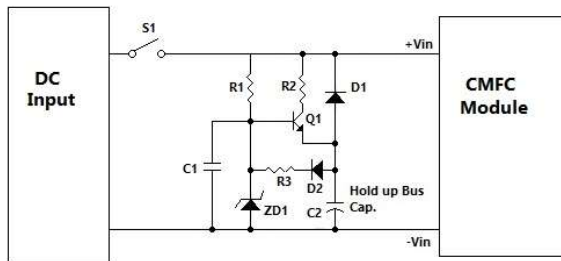

### 7.2 Output Ripple and Noise

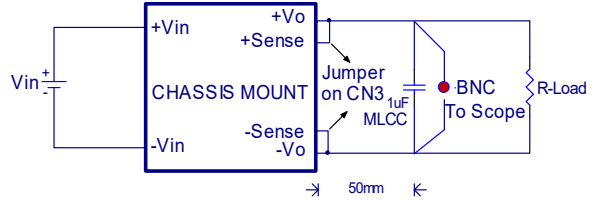

Output ripple and noise measured with 1uF ceramic capacitors across output. A 20 MHz bandwidth oscilloscope is normally used for the measurement.

The conventional ground clip on an oscilloscope probe should never be used in this kind of measurement. This clip, when placed in a field of radiated high frequency energy, acts as an antenna or inductive pickup loop, creating an extraneous voltage that is not part of the output noise of the converter.



Another method is shown in below, in case of coaxial-cable/BNC is not available. The noise pickup is eliminated by pressing scope probe ground ring directly against the -Vout terminal while the tip contacts the +Vout terminal. This makes the shortest possible connection across the output terminals.

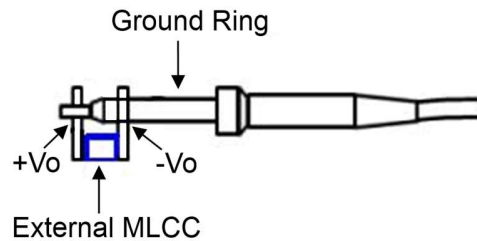

### 7.3 Output Capacitance

The CQB150W-110SXX-CMFC(D) series converters provide unconditional stability with or without external capacitors. For good transient response, low ESR output capacitors should be located close to the point of load (<100mm). PCB design emphasizes low resistance and inductance tracks in consideration of high current applications. Output capacitors with their associated ESR values have an impact on loop stability and bandwidth. Cincon's converters are designed to work with load capacitance to see technical specifications.



# CQB150W-110S CMFC(D)Series Application Note V13

## 8. Series and Parallel Operation

### 8.1 Series Operation

Series operation is possible by connecting the outputs two or more units. Connection is shown in below. The output current in series connection should be lower than the lowest rate current in each power module.

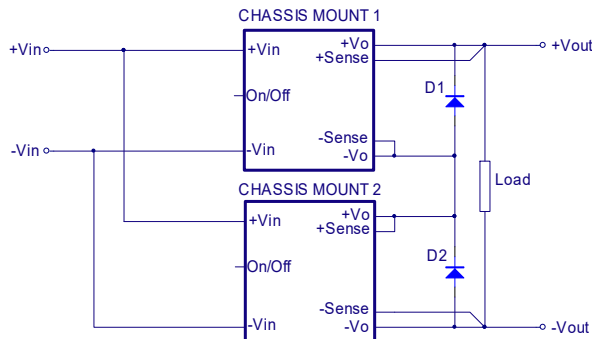

Simple Series Operation Connect Circuit

**Note:**

Recommend Schottky diode (D1, D2) be connected across the output of each series connected converter, so that if one converter shuts down for any reason, then the output stage won't be thermally overstressed. Without this external diode, the output stage of the shut-down converter could carry the load current provided by the other series converters, with its MOSFETs conducting through the body diodes. The MOSFETs could then be overstressed and fail. The external diode should be capable of handling the full load current for as long as the application is expected to run with any unit shut down.

Series for  $\pm$ output operation is possible by connecting the outputs two units, as shown in the schematic below.

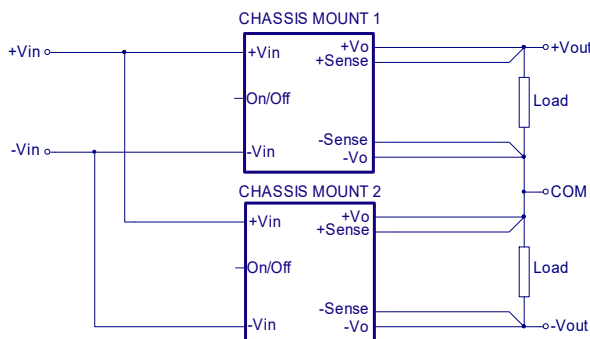

Simple  $\pm$ Output Operation Connect Circuit

### 8.2 Parallel Operation

The CQB150W-110SXX-CMFC(D) series parallel operation is not possible.

### 8.3 Redundant Operation

Parallel for redundancy operation is possible by connecting the units as shown in the schematic below. The current of each converter become unbalance by a slight difference of the output voltage. Make sure that the output voltage of units of equal value and the output current from each power supply does not exceed the rate current. Suggest use an internal variable resistor to adjust output voltage from each power supply.

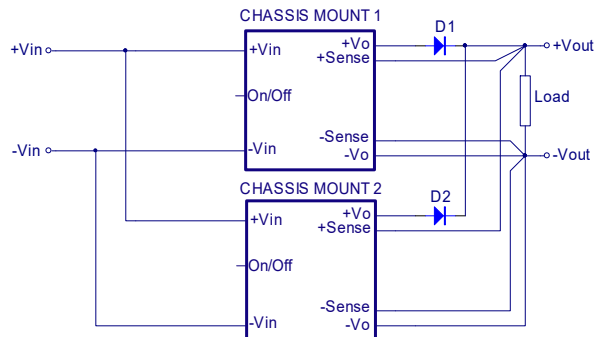

Simple Redundant Operation Connect Circuit





# CQB150W-110S CMFC(D)Series

## Application Note V13

---

## 9. Thermal Design

### 9.1 Operating Temperature Range

The CQB150W-110SXX-CMFC(D) series converters can be operated within a wide case temperature range of -40°C to 100°C. Consideration must be given to the derating curves when ascertaining maximum power that can be drawn from the converter. The maximum power drawn from chassis mount models is influenced by usual factors, such as:

- Input voltage range
- Output load current
- Forced air or natural convection
- Heat sink optional

### 9.2 Convection Requirements for Cooling

To predict the approximate cooling needed for the chassis mount module, refer to the power derating curves in **section 9.4**. These derating curves are approximations of the ambient temperatures and airflows required to keep the power module temperature below its maximum rating. Once the module is assembled in the actual system, the module's aluminum plate (point A) and aluminum capacitor (point B) temperature should be monitored to ensure it does not exceed 100°C (measuring point A and measuring point B refer to the **section 6.4**).

### 9.3 Thermal Considerations

The power module operates in a variety of thermal environments; however, sufficient cooling should be provided to help ensure reliable operation of the unit. Heat is removed by conduction, convection, and radiation to the surrounding environment. The example is presented in **section 9.4**. The power output of the module should not be allowed to exceed rated power ( $V_{o\_set} \times I_{o\_max}$ ).

### 9.4 Power Derating

The operating case temperature range of CQB150W-110SXX-CMFC(D) series is -40°C to +100°C. When operating the CQB150W-110SXX-CMFC(D) series, proper derating or cooling is needed. The point A and point B maximum temperature under any operating condition should not exceed 100°C (point A and point B refer to the **section 6.4**). The following curve is the de-rating curve of CQB150W-110SXX-CMFC(D) series with heat sink.



# CQB150W-110S CMFC(D)Series Application Note V13

The test condition refer to following figures.

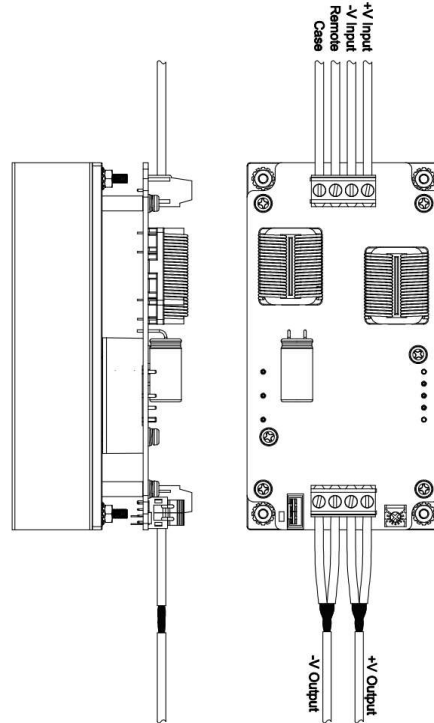

Figures 1 CQB150W-110SXX-CMFC with Heat Sink FBL254

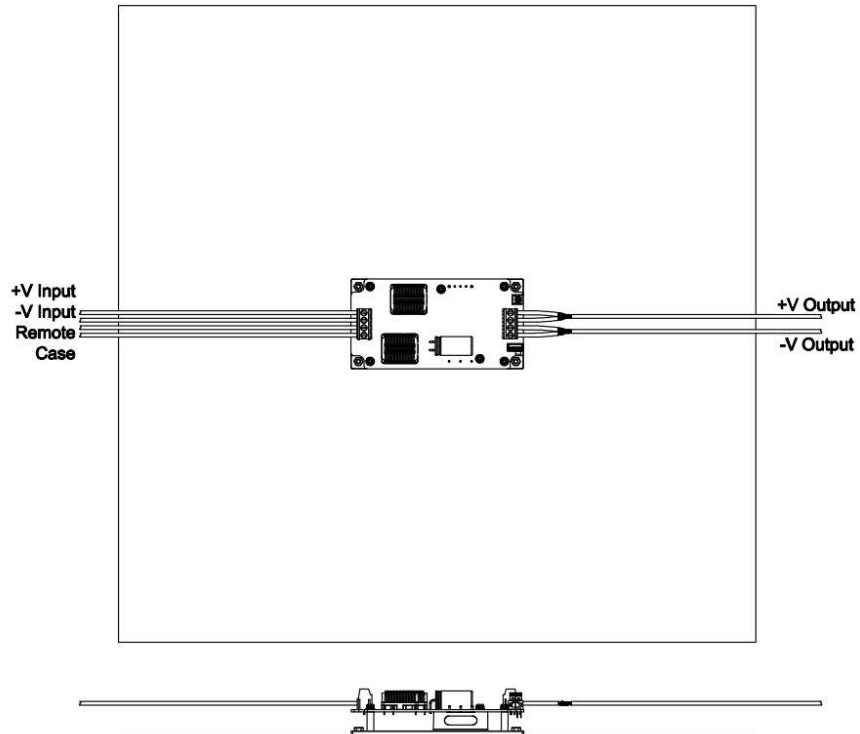

Figures 2 CQB150W-110SXX-CMFC with Heat Sink Aluminum Plate (17x17x0.04 inch)



# CQB150W-110S CMFC(D)Series Application Note V13

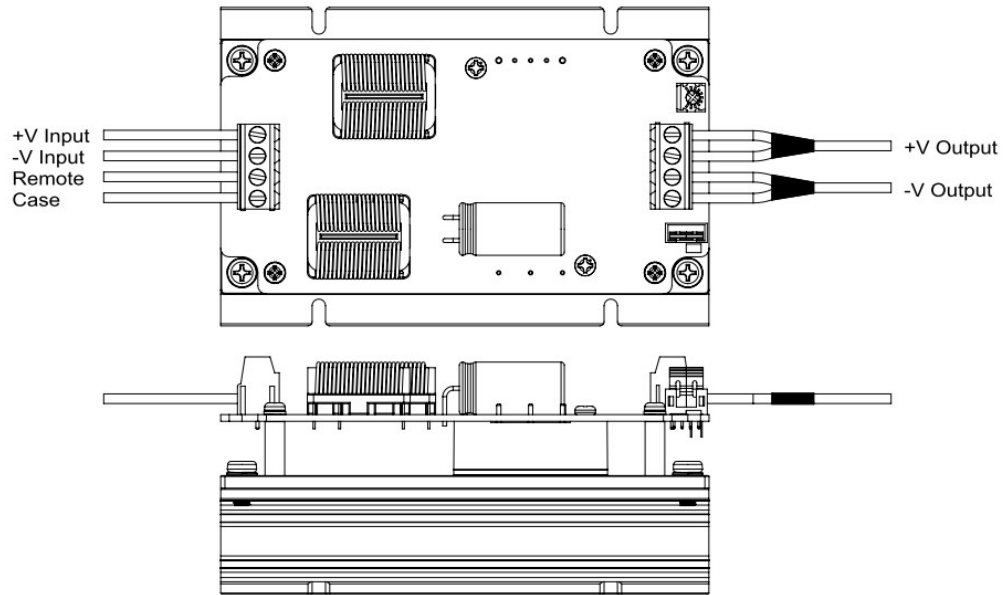

Figures 3 CQB150W-110SXX-CMFC with Heat Sink CMLH01



## CQB150W-110S CMFC(D)Series Application Note V13

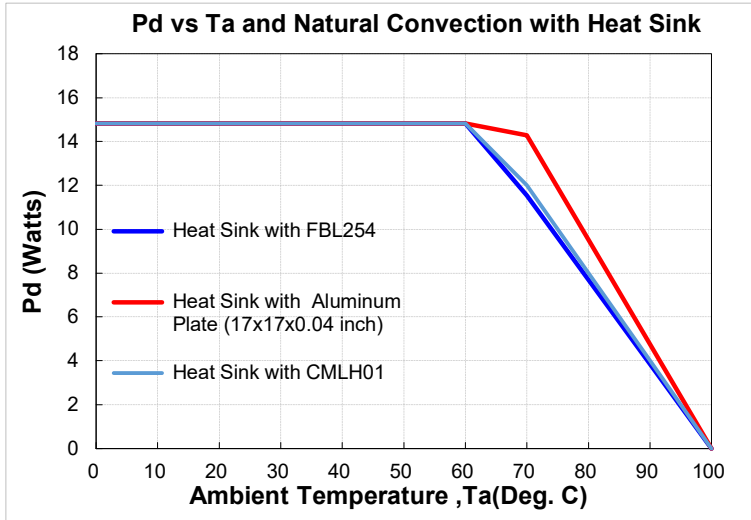

AIR FLOW RATE	TYPICAL R <sub>ca</sub>
Heat Sink with FBL254	2.6 °C/W
Heat Sink with Iron Plate (17x17x0.04 inch)	2.1 °C/W
Heat Sink with CMLH01	2.5 °C/W

**Example:**

What is the minimum airflow necessary for a CQB150W-110S12-CMFC with heat sink FBL254 (M-B012) operating at nominal line voltage, an output current of 12.5A, and a maximum ambient temperature of 60°C?

**Solution:**

**Given:**  $V_{in} = 110V_{dc}$ ,  $V_o = 12V_{dc}$ ,  $I_o = 12.5A$

**Determine Power dissipation (P<sub>d</sub>):**  $P_d = P_i - P_o = P_o(1-\eta)/\eta$ ,  $P_d = 12 \times 12.5 \times (1-0.91)/0.91 = 14.83$  Watts

**Determine airflow:** Given:  $P_d = 14.83W$  and  $T_a = 60^\circ C$

**Check Power Derating curve:** Heat sink with FBL254 (M-B012)

**Verify:**

Maximum temperature rise is  $\Delta T = P_d \times R_{ca} = 14.83 \times 2.6 = 38.5^\circ C$

Maximum case temperature is  $T_c = T_a + \Delta T = 98.5^\circ C < 100^\circ C$

**Where:**

The  $R_{ca}$  is thermal resistance from case to ambient environment.

$T_a$  is ambient temperature and  $T_c$  is case temperature.



# CQB150W-110S CMFC(D)Series Application Note V13

## 9.5 Heat Sinks

Heat Sink FBL254 (M-B012)

All Dimension In mm

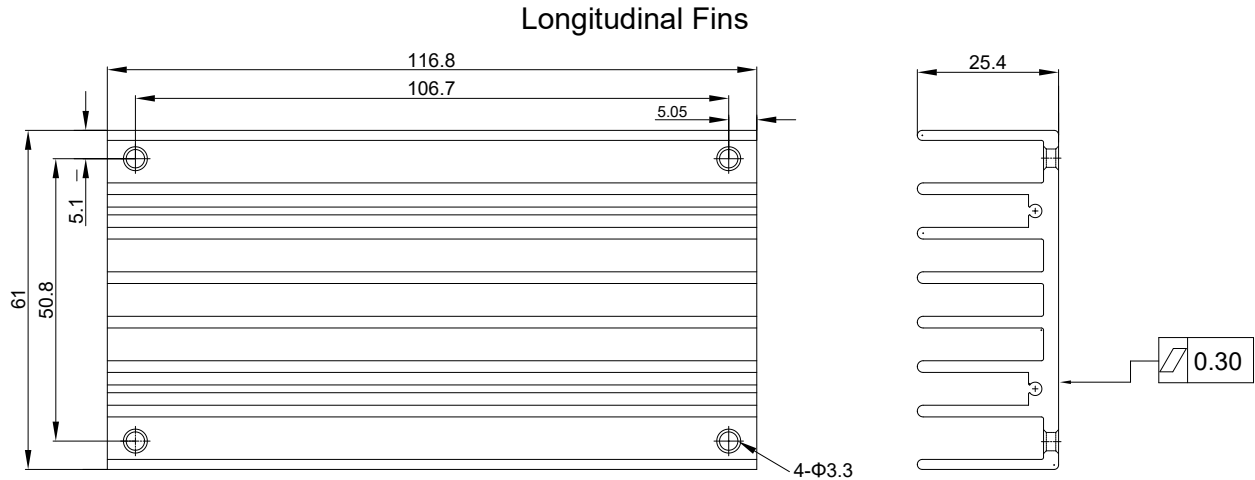

Heat Sink (Clear Mounting Inserts  $\Phi 3.3$ mm Through): 116.8\*61\*25.4 FBL254 (M-B012) G6620090204  
 Thermal PAD PF01: PMP-P400 60\*115.8\*0.23 (G6135041073)  
 Screw Nut K320N: M3\*20L (G75A1300052) & NH+WOM3\*P0.5N (G75A2440392)

Heat Sink CMLH01

All Dimension In mm

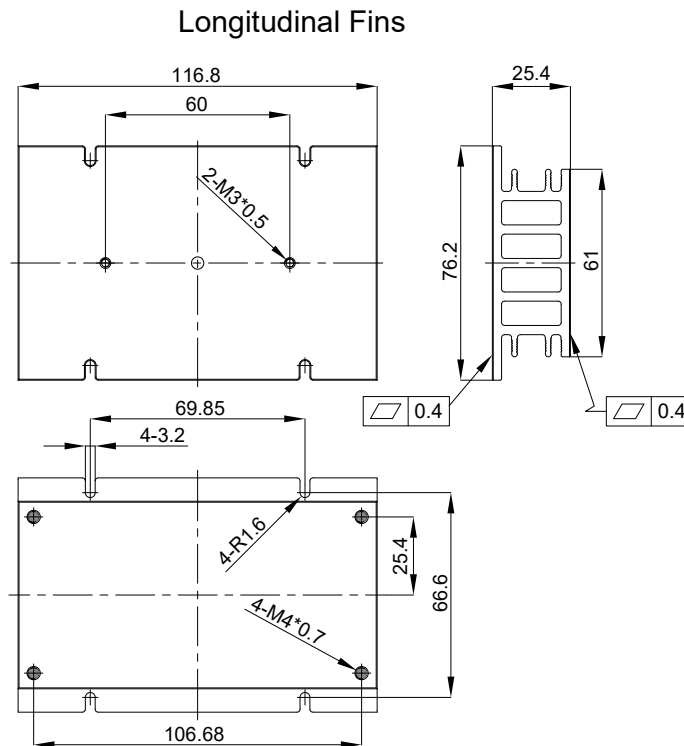

Heat Sink : 116.8\*76.2\*25.4 CMLH01 (M-C1618) G6621100202  
 Thermal PAD PF01: PMP-P400 60\*115.8\*0.23 (G6135041073)  
 Screws: SMP4X8N M4\*8mm (G75A3300992) & Washer (G75A47A0832)



# CQB150W-110S CMFC(D)Series Application Note V13

## 10. Safety & EMC

### 10.1 Input Fusing and Safety Considerations

The CQB150W-110SXX-CMFC(D) series converters have no internal fuse. In order to achieve maximum safety and system protection, always use an input line fuse. We recommended a 6A time delay fuse for all models. Chassis mount module have a transient voltage suppressor diode (TVS) across the input terminal to protect the unit against surge or spike voltage and input reverse voltage (as shown).

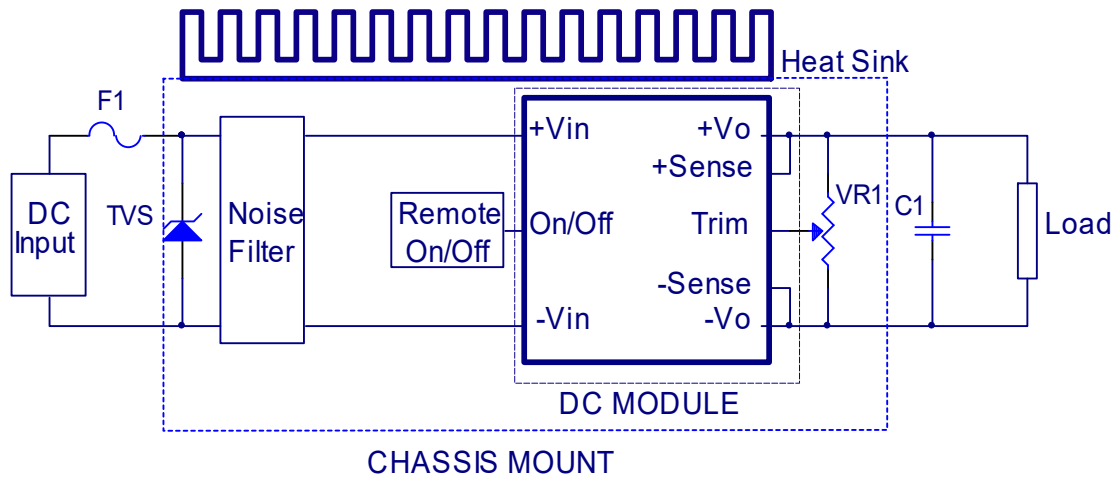

### 10.2 EMC Considerations

- (1) EMI Test standard: EN55032 Class A Conducted & Radiated Emission  
Test Condition: Input Voltage: 110Vdc, Output Load: Full Load

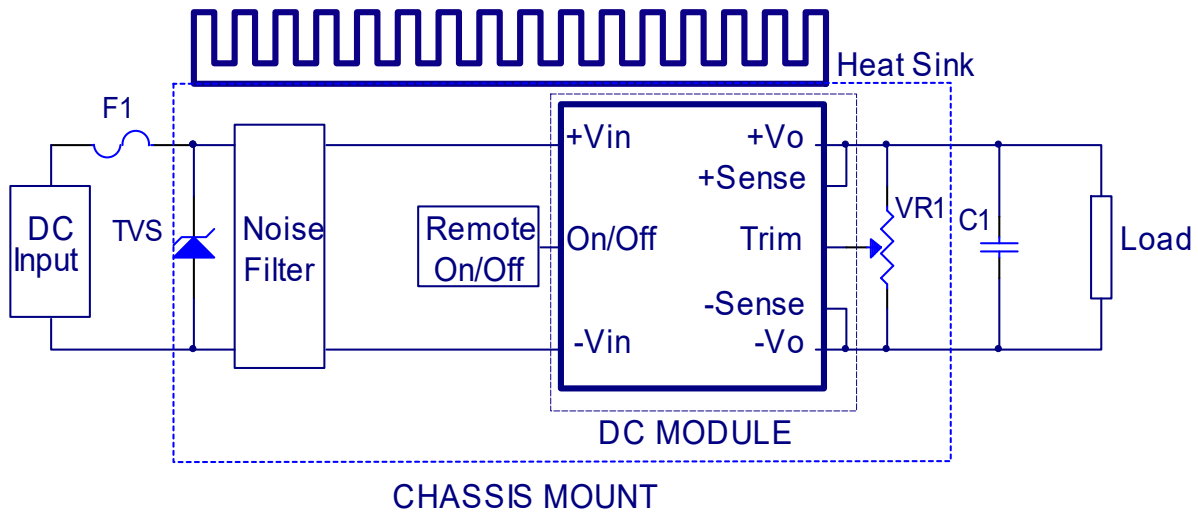

Connection circuit for EN55032 CLASS A EMI testing



# CQB150W-110S CMFC(D)Series

## Application Note V13

### Input Conducted Emission:

CQB150W-110S3V3-CMFC

Line

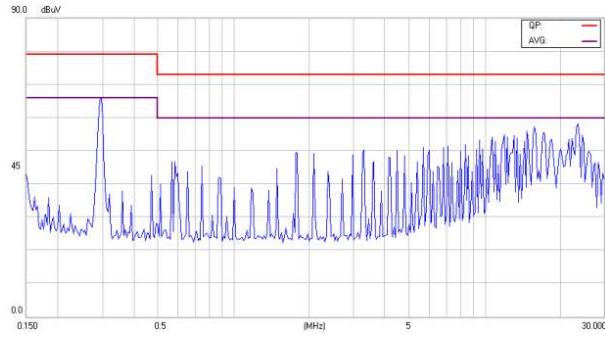

Neutral

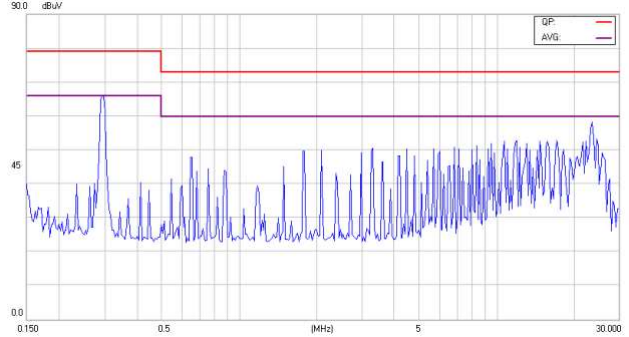

CQB150W-110S05-CMFC

Line

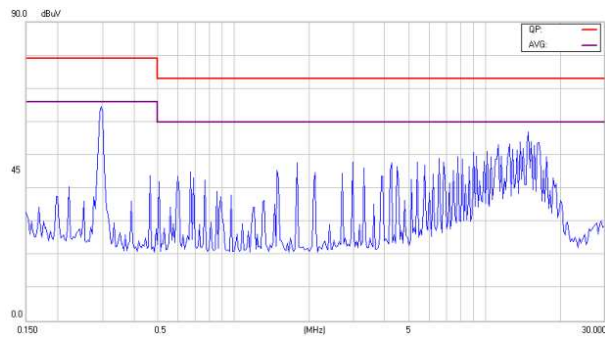

Neutral

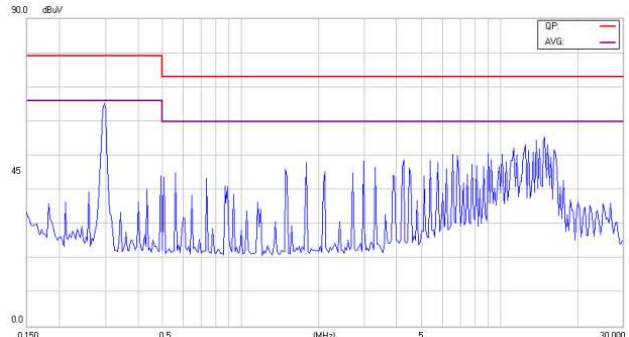

CQB150W-110S12-CMFC

Line

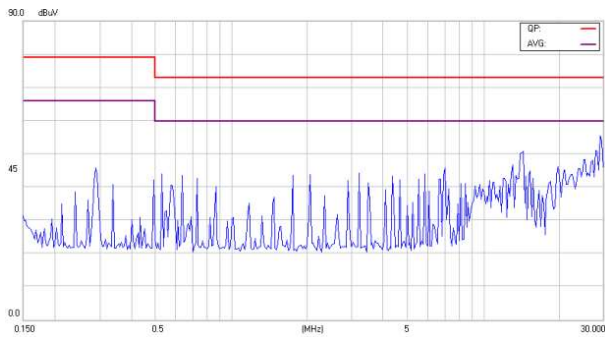

Neutral

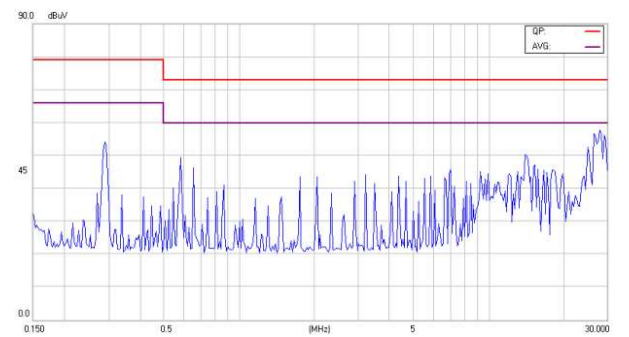



# CQB150W-110S CMFC(D)Series Application Note V13

## CQB150W-110S15-CMFC

Line

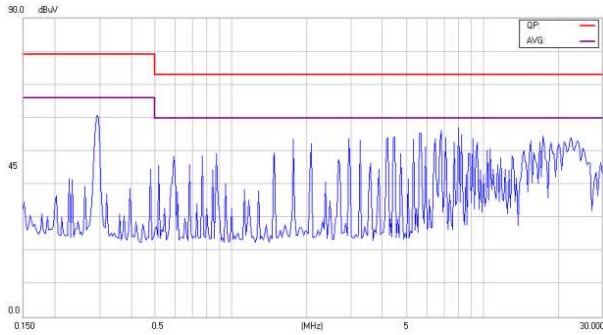

Neutral

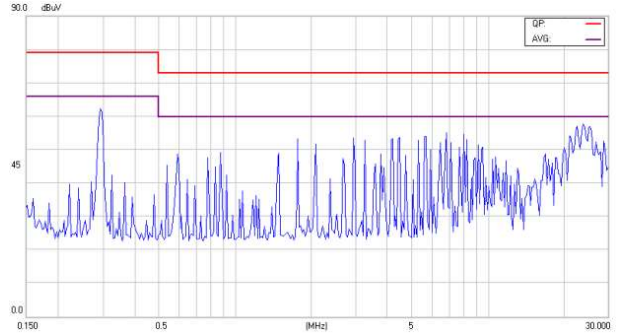

## CQB150W-110S24-CMFC

Line

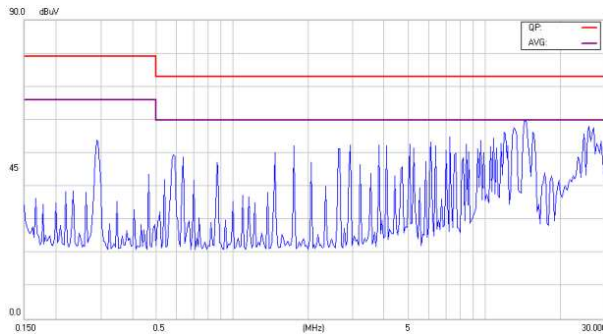

Neutral

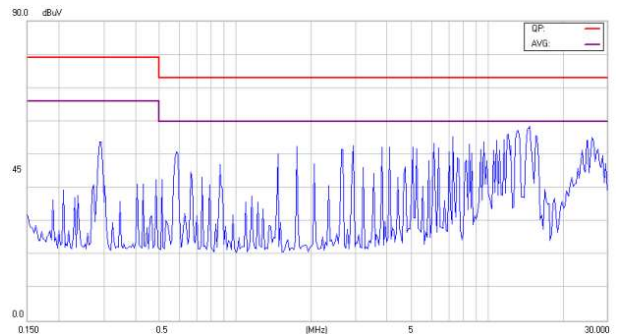

## CQB150W-110S28-CMFC

Line

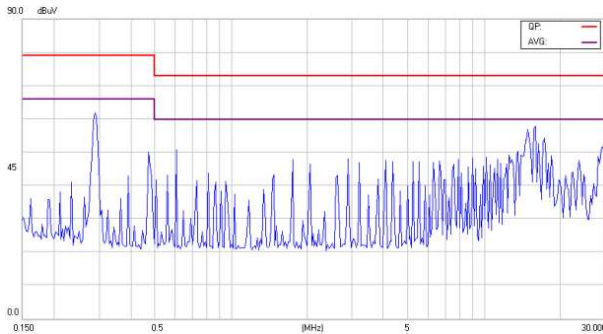

Neutral

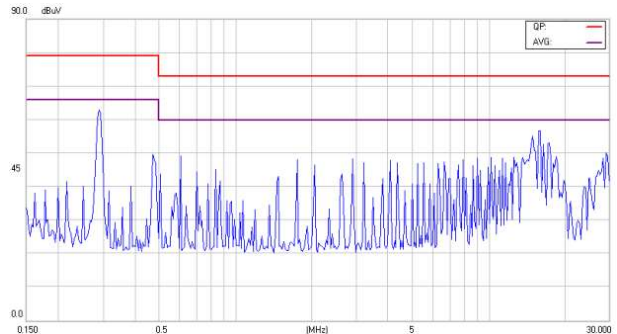

## CQB150W-110S48-CMFC

LINE

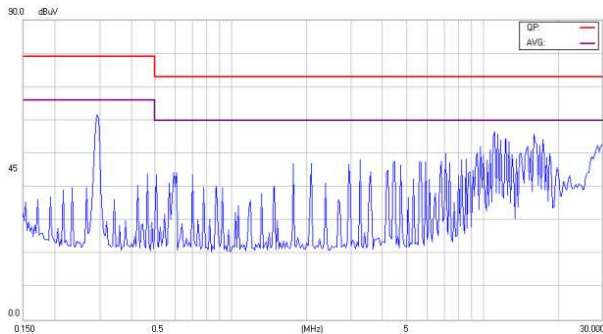

Neutral

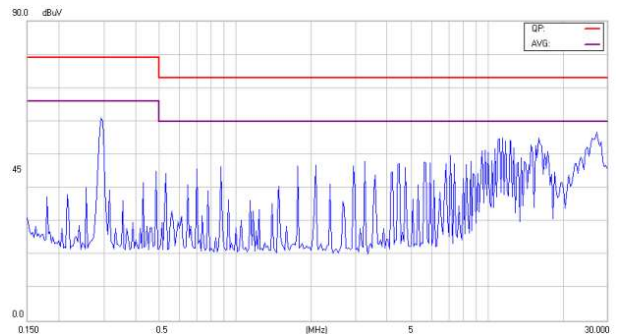





# CQB150W-110S CMFC(D)Series Application Note V13

## Radiated Emission:

VERTICAL

CQB150W-110S3V3-CMFC

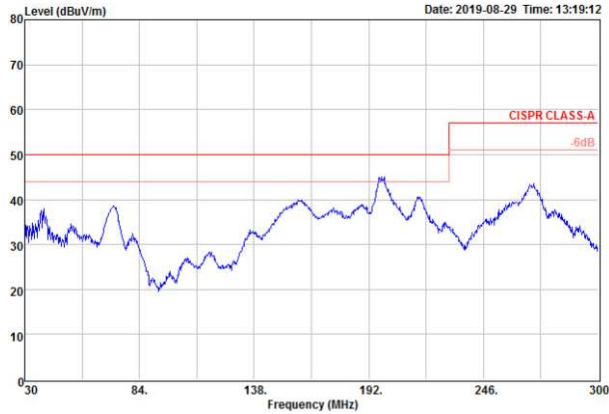

CQB150W-110S05-CMFC



CQB150W-110S12-CMFC

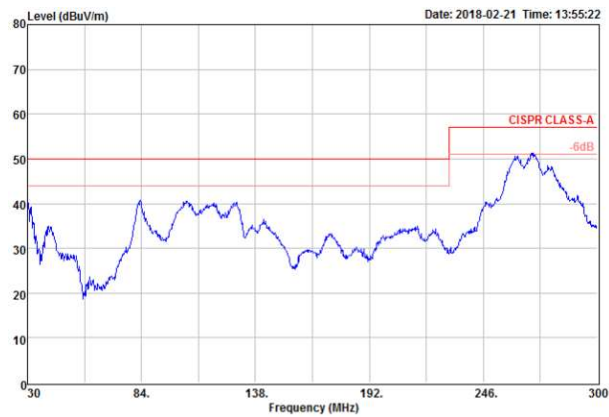

CQB150W-110S15-CMFC

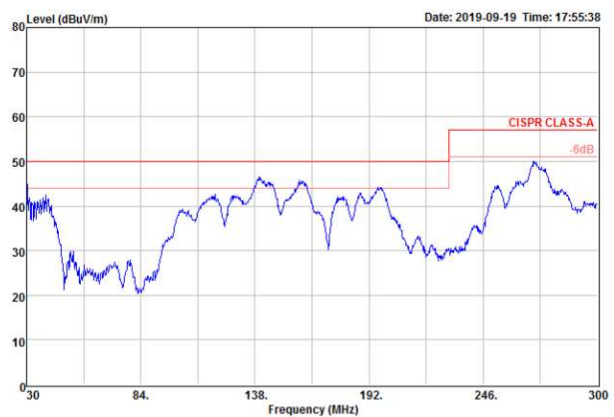

CQB150W-110S24-CMFC

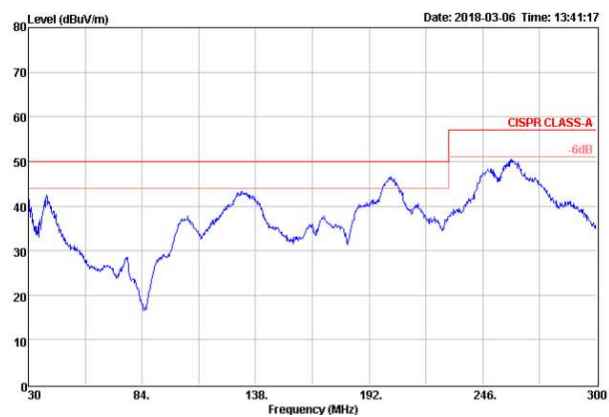

CQB150W-110S28-CMFC

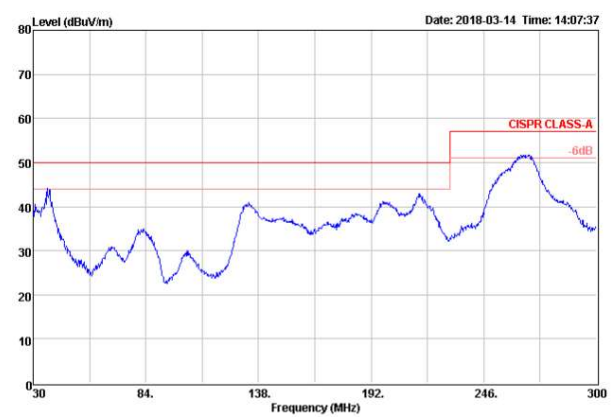



# CQB150W-110S CMFC(D)Series Application Note V13

CQB150W-110S48-CMFC

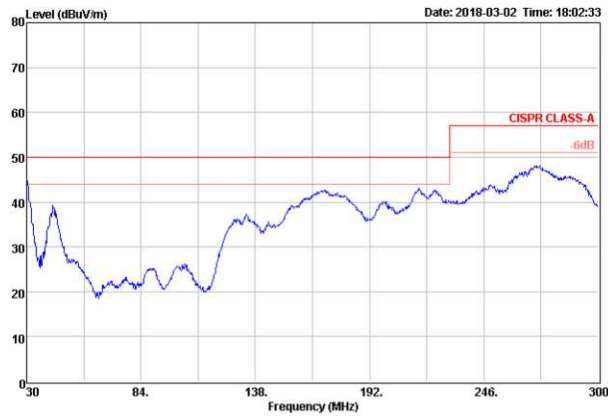

#### Headquarters:

14F, No.306, Sec.4, Hsin Yi Rd.  
Taipei, Taiwan  
Tel: 886-2-27086210  
Fax: 886-2-27029852  
E-mail: [sales@cincon.com.tw](mailto:sales@cincon.com.tw)  
Web Site: <https://www.cincon.com>

#### CINCON ELECTRONICS CO., LTD.

#### Factory:

No. 8-1, Fu Kung Rd.  
Fu Hsing Industrial Park  
Fu Hsing Hsiang,  
ChangHua Hsien, Taiwan  
Tel: 886-4-7690261  
Fax: 886-4-7698031

#### Cincon North America:

1655Mesa Verde Ave. Ste 180  
Ventura, CA93003  
Tel: 805-639-3350  
Fax: 805-639-4101  
E-mail: [info@cincon.com](mailto:info@cincon.com)