



CHB200W Series Application Note V15

ISOLATED DC-DC CONVERTER CHB200W SERIES APPLICATION NOTE



Approved By:

Department	Approved By	Checked By	Written By
Research and Development Department	Jacky	Danny/Eunice	Joyce
Design Quality Department	Benny	JoJo	



CHB200W Series Application Note V15

Contents

1. Introduction	3
2. DC-DC Converter Features.....	3
3. Electrical Block Diagram	3
4. Technical Specifications.....	4
5. Main Features and Functions.....	8
5.1 Operating Temperature Range.....	8
5.2 Output Voltage Adjustment.....	8
5.3 Over Current Protection.....	8
5.4 Output Over Voltage Protection.....	8
5.5 Remote On/Off.....	8
5.6 UVLO (Under voltage Lock Out).....	8
5.7 Over Temperature Protection	8
6. Applications.....	9
6.1 Recommended Layout, PCB Footprint and Soldering Information.....	9
6.2 Convection Requirements for Cooling	9
6.3 Thermal Considerations	9
6.4 Input Capacitance at the Power Module	9
6.5 Power De-Rating.....	10
6.6 Half Brick Heat Sinks:.....	11
6.7 Efficiency VS. Load	12
6.8 Test Set-Up.....	15
6.9 Output Voltage Adjustment.....	15
6.10 Output Remote Sensing	17
6.11 Output Ripple and Noise	18
6.12 Output Capacitance.....	18
7. Safety & EMC	19
7.1 Input Fusing and Safety Considerations	19
7.2 EMC Considerations	19
8. Part Number.....	24
9. Mechanical Specifications.....	24
9.1 Mechanical Outline Diagrams.....	24



CHB200W Series Application Note V15

1. Introduction

This specification describes the features and functions of Cincon's CHB200W series of isolated DC-DC Converters. These are highly efficient, reliable and compact, high power density, single output DC/DC converters. The modules can be used in the field of telecommunications, data communications, wireless communications, servers etc. The CHB200W series can deliver up to 50A output current and provide a precisely regulated output voltage over a wide range of 10-36 and 18-75VDC. The modules can achieve high efficiency up to 89%. The module offers direct cooling of dissipative components for excellent thermal performance. Standard features include remote on/off(positive or negative), remote sense, output voltage adjustment, over voltage, over current and over temperature protection.

2. DC-DC Converter Features

- 165-200W Isolated Output
- Efficiency up to 89%
- Regulated Output
- Fixed Switching Frequency
- Input Under Voltage Lockout Protection
- Over Voltage/Current Protection
- Remote On/Off
- Continuous Short Circuit Protection
- Industry Standard Half-Brick Package
- Fully Isolated to 1500VDC
- UL60950-1 Approval (Except 28 Vout & CHB200W-48S3V3)

3. Electrical Block Diagram

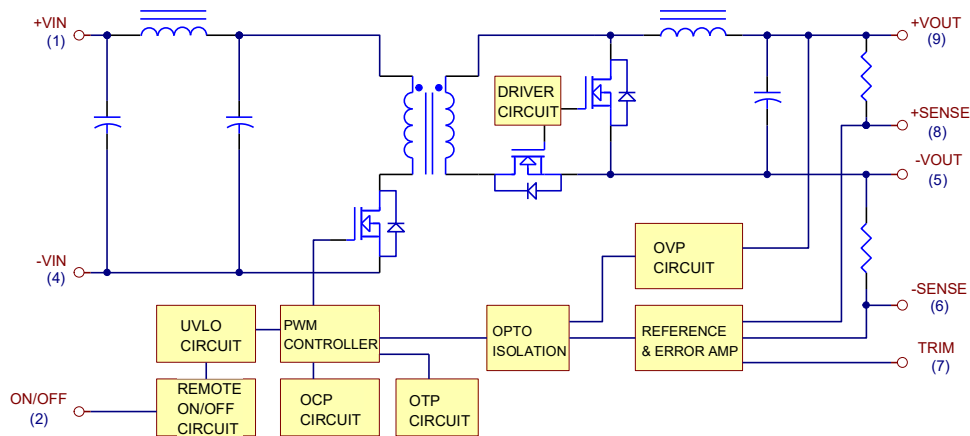

Electrical block diagram for 5Vout and 3.3Vout

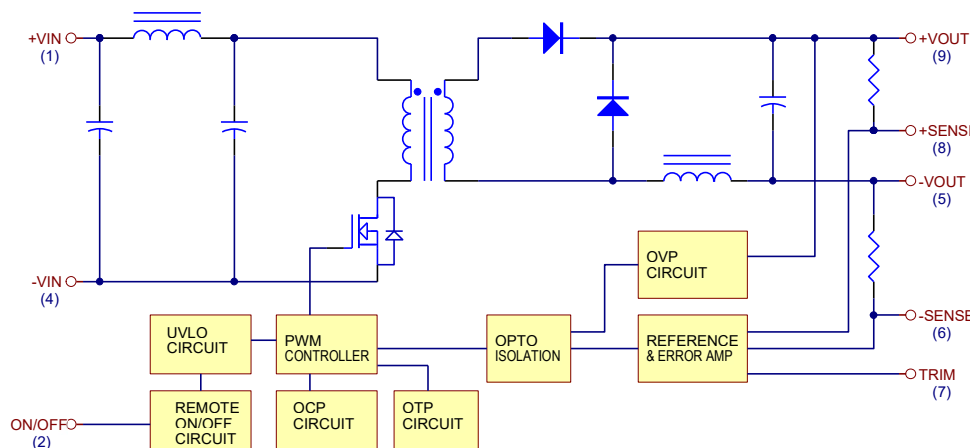

Electrical block diagram for other modules



CHB200W Series

Application Note V15

4. Technical Specifications

(All specifications are typical at nominal input, full load at 25°C unless otherwise noted.)

ABSOLUTE MAXIMUM RATINGS

Stresses in excess of the absolute maximum ratings can cause permanent damage to the device. These are absolute stress ratings only, functional operation of the device is not implied at these or any other conditions in excess of those given in the operations sections of the data sheet. Exposure to absolute maximum ratings for extended periods can adversely affect the device reliability.

PARAMETER	NOTES and CONDITIONS	Device	Min.	Typical	Max.	Units
Input Voltage						
Continuous		24SXX	-0.3		36	V_{dc}
		48SXX	-0.3		75	
Transient	100ms	24SXX			50	V_{dc}
		48SXX			100	
Operating Case Temperature		All	-40		100	°C
Storage Temperature		All	-55		105	°C
Isolation Voltage	1 Minute, input/output, input/case, output/case	All	1500			V_{dc}

INPUT CHARACTERISTICS

PARAMETER	NOTES and CONDITIONS	Device	Min.	Typical	Max.	Units
Operating Input Voltage		24SXX	10	24	36	V_{dc}
		48SXX	18	48	75	
Input Under Voltage Lockout						
Turn-On Voltage Threshold		24SXX	9.2	9.6	10	V_{dc}
		48SXX	16	17	18	
Turn-Off Voltage Threshold		24SXX	8.4	8.8	9.2	V_{dc}
		48SXX	15	16	17	
Lockout Hysteresis Voltage		24SXX		0.8		V_{dc}
		48SXX		1		
Maximum Input Current	100% Load, $V_{in}=10V$ for 24SXX	24S3V3		18		A
		24S12		27		
	100% Load, $V_{in}=18V$ for 48SXX	48S12		13.5		
		Others		13		
No-Load Input Current		24S3V3		130		mA
		24S05		150		
		24S12		50		
		24S15		50		
		24S24		45		
		24S28		55		
		24S48		60		
		48S3V3		80		
		48S05		80		
		48S12		60		
		48S15		60		
		48S24		60		
		48S28		50		
48S48		50				
Inrush Current (I^2t)		All			0.5	A^2s



CHB200W Series

Application Note V15

OUTPUT CHARACTERISTICS

PARAMETER	NOTES and CONDITIONS	Device	Min.	Typical	Max.	Units
Output Voltage Set Point	V_{in} =Nominal V_{in} , $I_o = I_{o_max}$, $T_c=25^\circ\text{C}$	$V_o=3.3\text{V}$	3.267	3.3	3.333	V_{dc}
		$V_o=5.0\text{V}$	4.95	5	5.05	
		$V_o=12\text{V}$	11.88	12	12.12	
		$V_o=15\text{V}$	14.85	15	15.15	
		$V_o=24\text{V}$	23.76	24	24.24	
		$V_o=28\text{V}$	27.72	28	28.28	
		$V_o=48\text{V}$	47.52	48	48.48	
Output Voltage Regulation						
Load Regulation	$I_o=I_{o_min.}$ to $I_{o_max.}$	All			± 0.2	%
Line Regulation	V_{in} =low line to high line	All			± 0.2	%
Temperature Coefficient	$T_c=-40^\circ\text{C}$ to 100°C	All			± 0.03	%/ $^\circ\text{C}$
Output Voltage Ripple and Noise						
Peak-to-Peak	5Hz to 20MHz bandwidth, Full load, 10uF tantalum and 1.0uF ceramic capacitors (48V: 10uF aluminum and 1uF ceramic capacitor across output)	$V_o=3.3\&5.0\text{V}$			100	mV
		$V_o=12\&15\text{V}$			150	
		$V_o=24\text{V}$			240	
		$V_o=28\text{V}$			280	
		$V_o=48\text{V}$			480	
RMS	5Hz to 20MHz bandwidth, Full load, 10uF tantalum and 1.0uF ceramic capacitors(48V: 10uF aluminum and 1uF ceramic capacitor across output)	$V_o=3.3\&5.0\text{V}$			40	mV
		$V_o=12\&15\text{V}$			60	
		$V_o=24\&28\text{V}$			100	
		$V_o=48\text{V}$			150	
Operating Output Current Range		$V_o=3.3\text{V}$	0		50	A
		$V_o=5.0\text{V}$	0		40	
		$V_o=12\text{V}$	0		16.7	
		$V_o=15\text{V}$	0		13.3	
		$V_o=24\text{V}$	0		8.3	
		$V_o=28\text{V}$	0		7.14	
		$V_o=48\text{V}$	0		4.2	
Output DC Current Limit Inception	Output voltage=90% nominal output voltage	All	110	125	160	%
Output Capacitance	Full load (resistive)	$V_o=3.3\text{V}$	0		10000	μF
		$V_o=5.0\text{V}$	0		10000	
		$V_o=12\text{V}$	0		2200	
		$V_o=15\text{V}$	0		2200	
		$V_o=24\text{V}$	0		2200	
		$V_o=28\text{V}$	100		2200	
		$V_o=48\text{V}$	47		2200	

DYNAMIC CHARACTERISTICS

PARAMETER	NOTES and CONDITIONS	Device	Min.	Typical	Max.	Units
Output Voltage Current Transient						
Step Change in Output Current	$d_i/d_t=0.1\text{A}/\mu\text{s}$, Load change from 75% to 100% to 75% of I_{o_max} .	24S3V3			± 7	%
		48S3V3			± 6	
		Others			± 5	
Setting Time (within 1% V_{out} Nominal)	$d_i/d_t=0.1\text{A}/\mu\text{s}$	All			500	μs



CHB200W Series Application Note V15

PARAMETER	NOTES and CONDITIONS	Device	Min.	Typical	Max.	Units
Turn-On Delay and Rise Time						
Turn-On Delay Time, From On/Off Control	$V_{on/off}$ to 10% V_{o_set}	All			75	ms
Turn-On Delay Time, From Input	$V_{in_min.}$ to 10% V_{o_set}	All			250	ms
Output Voltage Rise Time	10% V_{o_set} to 90% V_{o_set}	All			50	ms

EFFICIENCY

PARAMETER	NOTES and CONDITIONS	Device	Min.	Typical	Max.	Units
100% Load		24S3V3		87		%
		24S05		87		
		24S12		86		
		24S15		87		
		24S24		87		
		24S28		88.5		
		24S48		86		
		48S3V3		88		
		48S05		89		
		48S12		88		
		48S15		88		
		48S24		88		
		48S28		89		
48S48		87				

ISOLATION CHARACTERISTICS

PARAMETER	NOTES and CONDITIONS	Device	Min.	Typical	Max.	Units
Isolation Voltage	1 Minute, input/output, input/case, output/case	All			1500	V_{dc}
Isolation Resistance		All	10			MΩ
Isolation Capacitance		All		2000		pF

FEATURE CHARACTERISTICS

PARAMETER	NOTES and CONDITIONS	Device	Min.	Typical	Max.	Units
Switching Frequency		All		250		KHz
On/Off Control, Positive Remote On/Off Logic						
Logic Low (Module Off)		All	0		1.2	V
Logic High (Module On)		All	3.5 or Open Circuit		75	V
On/Off Control, Negative Remote On/Off Logic						
Logic High (Module Off)		All	3.5 or Open Circuit		75	V
Logic High (Module On)		All	0		1.2	V
On/Off Current (for Both Remote On/Off Logic)	$I_{on/off}$ at $V_{on/off}=0.0V$	All			1	mA
Leakage Current (for Both Remote On/Off Logic)	Logic high, $V_{on/off}=15V$	All			1	mA
Off Converter Input Current	Shutdown input idle current	All		10	15	mA



CHB200W Series Application Note V15

PARAMETER	NOTES and CONDITIONS	Device	Min.	Typical	Max.	Units
Output Voltage Trim Range	$V_{in}=10-10.8V$ for 24S28 $V_{in}=18-19V$ for 48S28 $I_{out}=\text{max. rated current}$	XXS28	-10		0	%
	$V_{in}=10.8-36V$, $P_{out}=\text{max. rated power}$ $I_{out}=\text{max. rated current}$	24S28	-10		+10	
	$V_{in}=19-75V$, $P_{out}=\text{max. rated power}$ $I_{out}=\text{max. rated current}$	48S28				
	$V_{in}=\text{high line - low line}$, $P_{out}=\text{max. rated power}$, $I_{out}=\text{max. rated current}$	Others	-10		+10	
Output Over Voltage Protection		All	115	125	140	%
Over-Temperature Shutdown		All		110		°C
Over Temperature Recovery		All		90		°C

GENERAL SPECIFICATIONS

PARAMETER	NOTES and CONDITIONS	Device	Min.	Typical	Max.	Units
MTBF	$I_o=100\%$ of I_{o_max} : $T_a=25^\circ\text{C}$ per MIL-HDBK-217F	All		600		K hours
Weight		All		114		grams



CHB200W Series Application Note V15

5. Main Features and Functions

5.1 Operating Temperature Range

The CHB200W series converters can be operated within a wide case temperature range of -40°C to 100°C . Consideration must be given to the de-rating curves when ascertaining maximum power that can be drawn from the converter. The maximum power drawn from half brick models is influenced by usual factors, such as:

- Input voltage range
- Output load current
- Forced air or natural convection

5.2 Output Voltage Adjustment

Section 6.8 describes in detail how to trim the output voltage with respect to its set point. The output voltage on all models is adjustable within the range of $+10\%$ to -10% .

5.3 Over Current Protection

The converter is protected against over current or short circuit conditions. At the instance of current-limit inception, the module enters a hiccup mode of operation, whereby it shuts down and automatically attempts to restart. While the fault condition exists, the module will remain in this hiccup mode, and can remain in this mode until the fault is cleared. The unit operates normally once the output current is reduced back into its specified range.

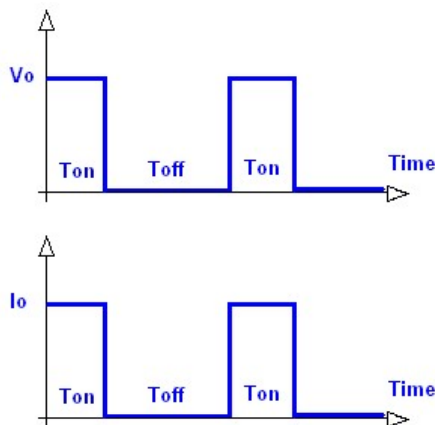

5.4 Output Over Voltage Protection

The converter is protected against output over voltage conditions. When the output voltage is higher than the specified range, the module enters a hiccup mode of operation. The operation is identical with over current protection.

5.5 Remote On/Off

The **on/off** input pin permits the user to turn the power module on or off via a system signal. Two remote **on/off** options are available. Positive logic turns the module on during a logic high voltage on the **on/off** pin, and off during a logic low. Negative logic remote **on/off** turns the module off during a logic high and on during a logic low. The **on/off** pin is internally pulled up through a resistor. A properly de-bounced mechanical switch, open collector transistor, or FET can be used to drive the input of the **on/off** pin.

If not using the remote **on/off** feature:

For positive logic, leave the **on/off** pin open.

For negative logic, short the **on/off** pin to $vin(-)$.

5.6 UVLO (Under Voltage Lock Out)

Input under voltage lockout is standard with this converter. At input voltages below the input under voltage lockout limit, the module operation is disabled.

5.7 Over Temperature Protection

These modules have an over temperature protection circuit to safeguard against thermal damage. When the case temperature rises above over temperature shutdown threshold, the converter will shut down to protect it from overheating. The module will automatically restart after it cools down.



CHB200W Series Application Note V15

6. Applications

6.1 Recommended Layout, PCB Footprint and Soldering Information

The system designer or end user must ensure that metal and other components in the vicinity of the converter meet the spacing requirements for which the system is approved. Low resistance and inductance PCB layout traces are the norm and should be used where possible. Due consideration must also be given to proper low impedance tracks between power module, input and output grounds. The recommended soldering profile and PCB layout are shown below.

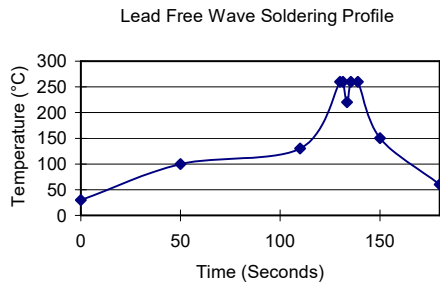

Note:

1. Soldering Materials: Sn/Cu/Ni
2. Ramp up rate during preheat: 1.4°C/Sec (from 50°C to 100°C)
3. Soaking temperature: 0.5°C/Sec (from 100°C to 130°C), 60±20 seconds
4. Peak temperature: 260°C, above 250°C 3~6 Seconds
5. Ramp up rate during cooling: -10.0°C/Sec (from 260°C to 150°C)

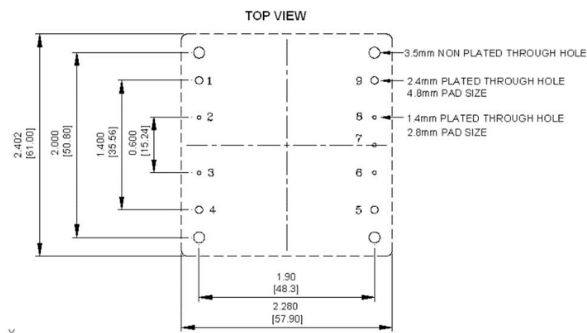

6.2 Convection Requirements for Cooling

To predict the approximate cooling needed for the half brick module, refer to the power de-rating curves in **section 6.5**. These de-rating curves are approximations of the ambient temperatures and airflows required to keep the power module temperature below its maximum rating. Once the module is assembled in the actual system, the module's temperature should be monitored to ensure it does not exceed 100°C as being measured at the center of the top of the case (thus verifying proper cooling).

6.3 Thermal Considerations

The power module operates in a variety of thermal environments; however, sufficient cooling should be provided to help ensure reliable operation of the unit. Heat is removed by conduction, convection, and radiation to the surrounding environment. The test data is presented in **section 6.5**. The power output of the module should not be allowed to exceed rated power ($V_{o_set} \times I_{o_max}$).

6.4 Input Capacitance at the Power Module

The converters must be connected to low AC source impedance. To avoid problems with loop stability source inductance should be low. Also, the input capacitors (C_{in}) should be placed close to the converter input pins to de-couple distribution inductance. However, the external input capacitors are chosen for suitable ripple handling capability. Low ESR capacitors are good choice. Circuit as shown as below represents typical measurement methods for reflected ripple current. C_1 and L_1 simulate a typical DC source impedance. The input reflected-ripple current is measured by current probe to oscilloscope with a simulated source Inductance (L_1).

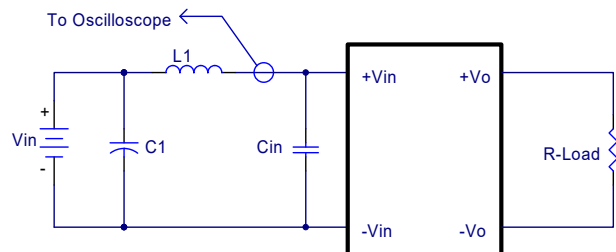

- C1: NC
- For 24SXX
- L1: 1.2uH
- Cin: 470uF ESR<0.2ohm @100KHz
- For 48SXX
- L1: 12uH
- Cin: 47uF ESR<0.7ohm @100KHz

Input Reflected-Ripple Test Setup



CHB200W Series Application Note V15

6.5 Power De-Rating

The operating case temperature range of CHB200W series is -40°C to +100°C. When operating the CHB200W series, proper de-rating or cooling is needed. The maximum case temperature under any operating condition should not exceed 100°C.

The following curve is the de-rating curve of CHB200W series without heat sink.

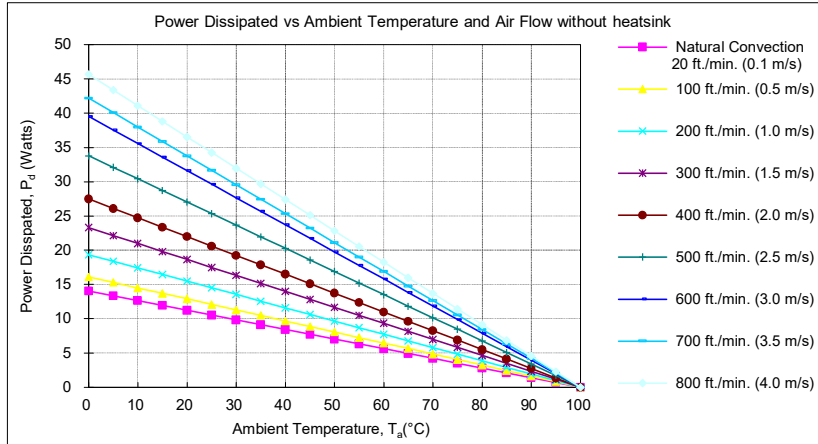

AIR FLOW RATE	TYPICAL R _{ca}
Natural convection	
20ft./min. (0.1m/s)	7.12°C/W
100 ft./min. (0.5m/s)	6.21°C/W
200 ft./min. (1.0m/s)	5.17°C/W
300 ft./min. (1.5m/s)	4.29°C/W
400 ft./min. (2.0m/s)	3.64°C/W
500 ft./min. (2.5m/s)	2.96°C/W
600 ft./min. (3.0m/s)	2.53°C/W
700 ft./min. (3.5m/s)	2.37°C/W
800 ft./min. (4.0m/s)	2.19°C/W

Example:

What is the minimum airflow necessary for a CHB200W-48S05 operating at nominal line voltage, an output current of 40A, and a maximum ambient temperature of 40°C.

Solution:

Given:

$$V_{in}=48V_{dc}, V_o=5V_{dc}, I_o=40A$$

Determine power dissipation (P_d):

$$P_d = P_i - P_o = P_o(1 - \eta) / \eta$$

$$P_d = 5V \times 40A \times (1 - 0.89) / 0.89 = 24.72 \text{ Watts}$$

Determine airflow:

$$\text{Given: } P_d = 24.72W \text{ and } T_a = 40^\circ C$$

Check power derating curve:

$$\text{Minimum airflow} = 800 \text{ ft./min.}$$

Verify:

Maximum temperature rise is

$$\Delta T = P_d \times R_{ca} = 24.72W \times 2.19 = 54.14^\circ C$$

Maximum case temperature is

$$T_c = T_a + \Delta T = 94.14^\circ C < 100^\circ C$$

Where:

The R_{ca} is thermal resistance from case to ambient environment

T_a is ambient temperature and T_c is case temperature



CHB200W Series Application Note V15

Example with heatsink HBT254 (M-C092):

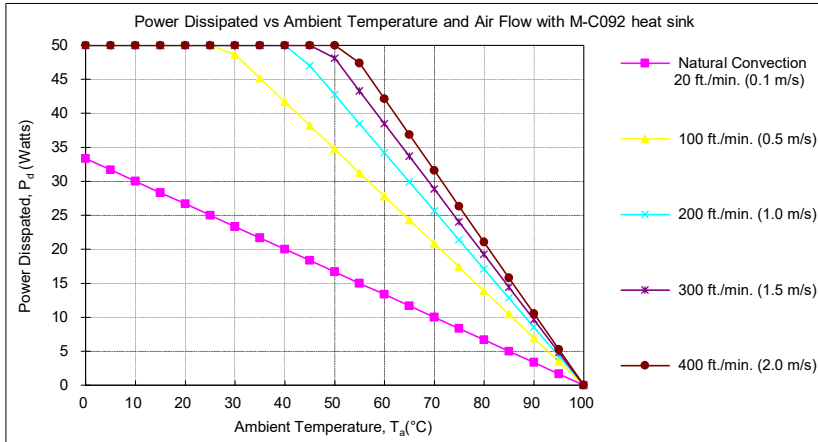

AIR FLOW RATE	TYPICAL R _{ca}
Natural convection 20ft./min. (0.1m/s)	3.00°C/W
100 ft./min. (0.5m/s)	1.44°C/W
200 ft./min. (1.0m/s)	1.17°C/W
300 ft./min. (1.5m/s)	1.04°C/W
400 ft./min. (2.0m/s)	0.95°C/W

What is the minimum airflow necessary for a CHB200W-48S12 operating at nominal line voltage, an output current of 16.7A, and a maximum ambient temperature of 40°C.

Solution:

Given:

$$V_{in}=48V_{dc}, V_o=12V_{dc}, I_o=16.7A$$

Determine power dissipation (P_d):

$$P_d=P_i-P_o=P_o(1-\eta)/\eta$$

$$P_d=12 \times 16.7 \times (1-0.88)/0.88=27.33\text{Watts}$$

Determine airflow:

$$\text{Given: } P_d=27.33\text{W and } T_a=40^\circ\text{C}$$

Check above power derating curve:

$$\text{Minimum airflow}=100 \text{ ft./min.}$$

Verify:

Maximum temperature rise is

$$\Delta T=P_d \times R_{ca}=27.33 \times 1.44=39.36^\circ\text{C}$$

Maximum case temperature is

$$T_c=T_a+\Delta T=79.36^\circ\text{C} < 100^\circ\text{C}$$

Where:

The R_{ca} is thermal resistance from case to ambient environment

T_a is ambient temperature and T_c is case temperature

6.6 Half Brick Heat Sinks:

Heat sinks assembly [refer to Datasheet-Thermal](#)



CHB200W Series Application Note V15

6.7 Efficiency VS. Load

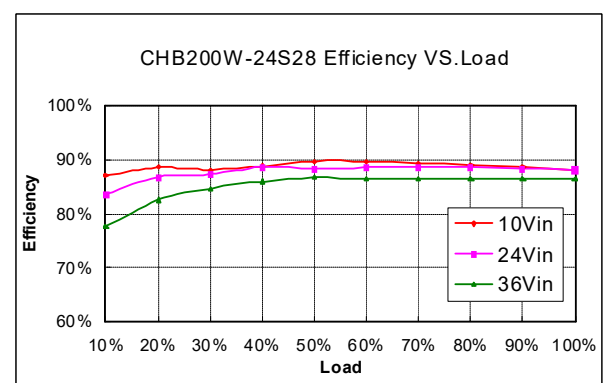
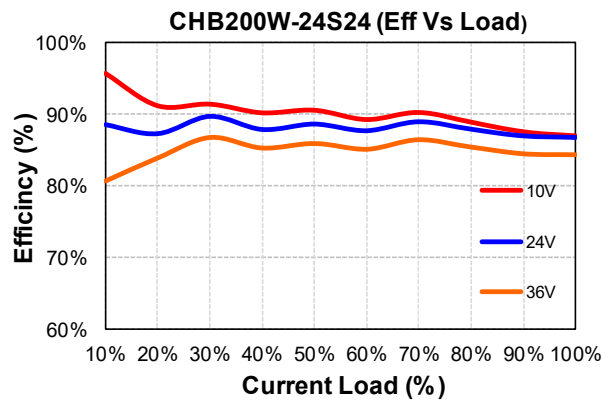
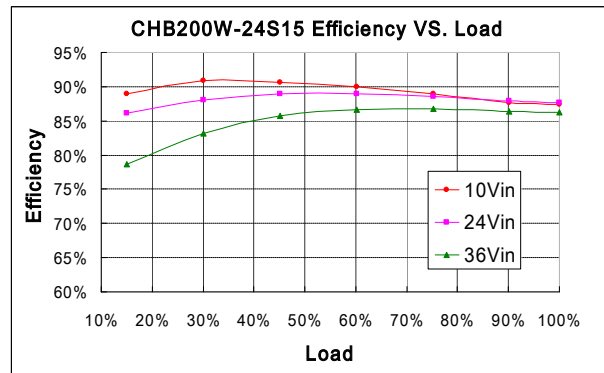
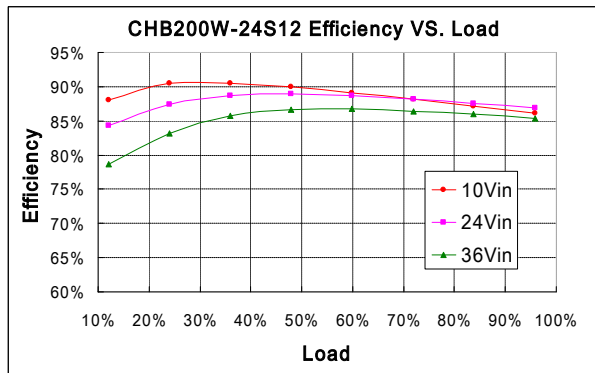
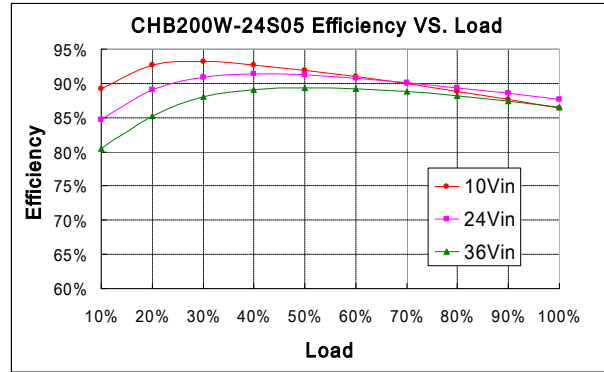
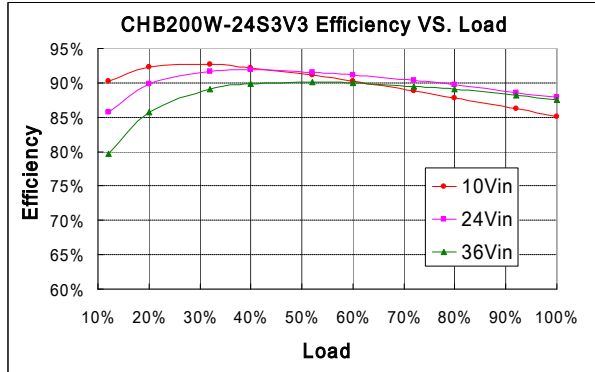



CHB200W Series Application Note V15

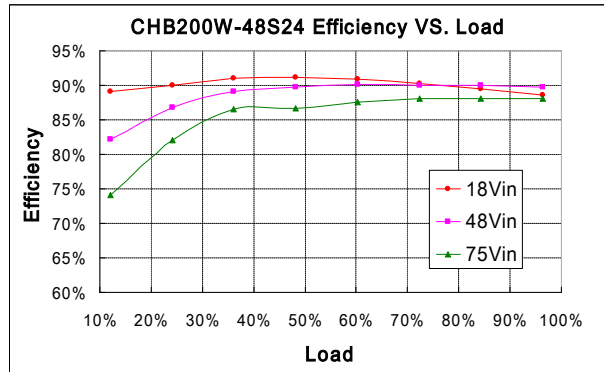
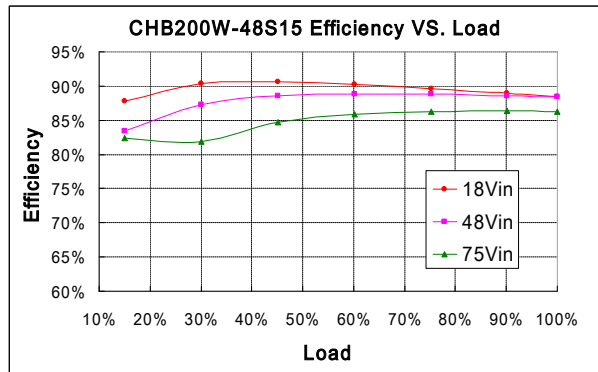
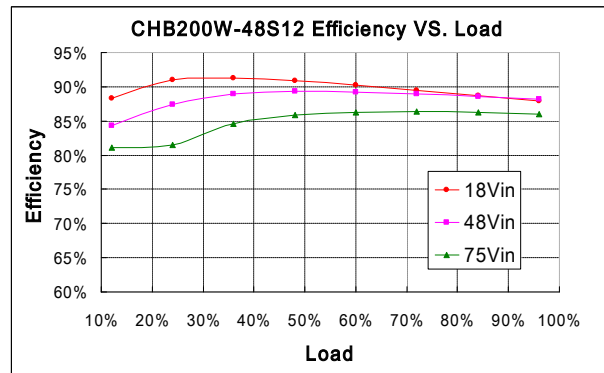
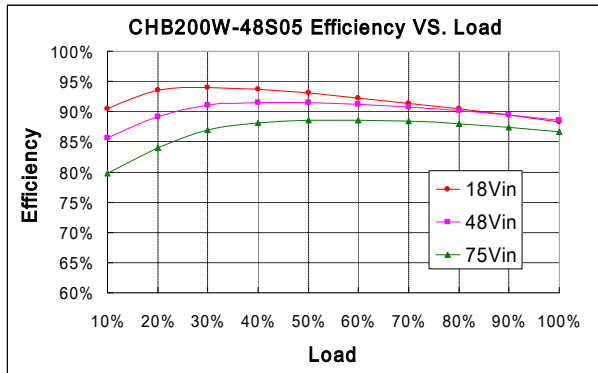
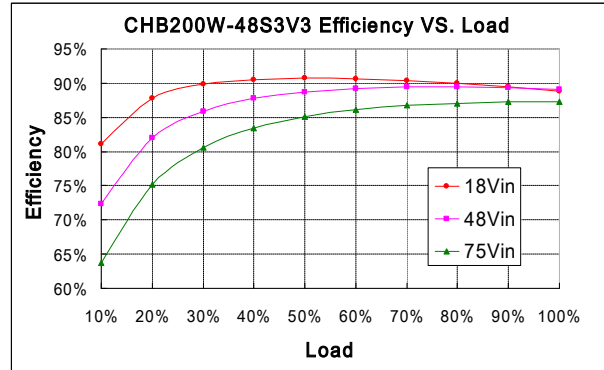
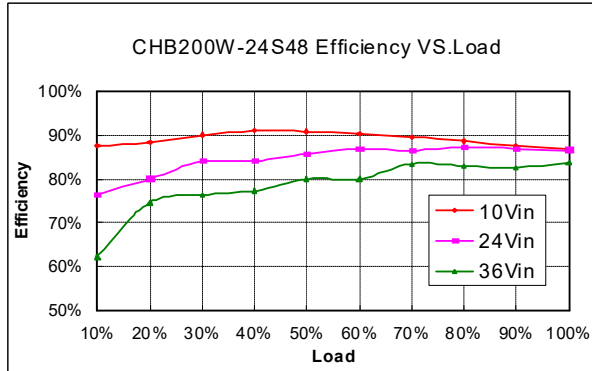



CHB200W Series Application Note V15

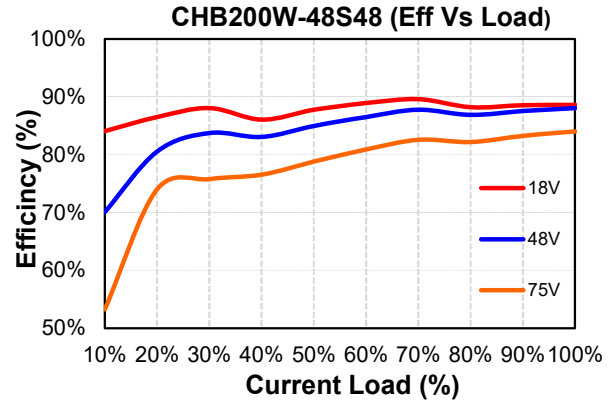
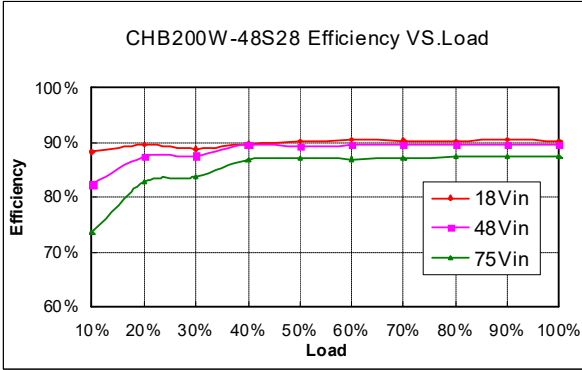



CHB200W Series Application Note V15

6.8 Test Set-Up

The basic test set-up to measure parameters such as efficiency and load regulation is shown below. When testing the modules under any transient conditions please ensure that the transient response of the source is sufficient to power the equipment under test. We can calculate:

- Efficiency
- Load regulation and line regulation

The value of efficiency is defined as:

$$\eta = \frac{V_o \times I_o}{V_{in} \times I_{in}} \times 100\%$$

Where:

- V_o is output voltage,
- I_o is output current,
- V_{in} is input voltage,
- I_{in} is input current

The value of load regulation is defined as:

$$Load.reg = \frac{V_{FL} - V_{NL}}{V_{NL}} \times 100\%$$

Where:

- V_{FL} is the output voltage at full load
- V_{NL} is the output voltage at no load

The value of line regulation is defined as:

$$Line.reg = \frac{V_{HL} - V_{LL}}{V_{LL}} \times 100\%$$

Where:

- V_{HL} is the output voltage of maximum input voltage at full load
- V_{LL} is the output voltage of minimum input voltage at full load

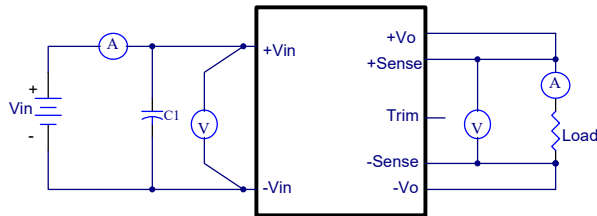

CHB200W Series Test Setup

Recommend C1 Value

C1: 470uF for 24Vin or 47uF for 48 Vin

For CHB200W series it's necessary to connect the input electrolytic capacitor C1 with low ESR to prevent the effective of input line inductance to the DC/DC converter.

6.9 Output Voltage Adjustment

The Trim input permits the user to adjust the output voltage up or down 10%. The Trim pin should be left open if trimming is not being used. Connecting an external resistor ($R_{trim-down}$) between the Trim pin and the $V_{out(-)}$ (or Sense(-)) pin decreases the output voltage. The following equation determines the required external resistor value to obtain a down percentage output voltage change of $\Delta\%$

Method 1

Connecting an external resistor between the Trim pin and either the $V_{out(+)}$ pin or the $V_{out(-)}$ pin (COM pin) , see Figure

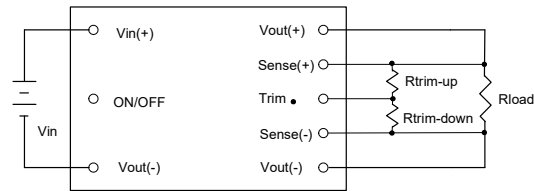

Output Voltage Trim Circuit Configuration

For V_o : 3.3, 5, 12, 15, 24, 28V

$$R_{trim-down} = \left[\frac{511}{\Delta\%} - 10.22 \right] k\Omega$$

For V_o : 48V

$$R_{trim-down} = \left[\frac{2000}{\Delta\%} - 40 \right] k\Omega$$

Where

$$\Delta\% = \left(\frac{V_{o,set} - V_{desired}}{V_{o,set}} \right) \times 100$$

For example, to trim-down the output voltage of 12V module (CHB200W-48S12) by 5% to 11.4V, $R_{trim-down}$ is calculated as follow:

$\Delta\%=5$

$$R_{trim-down} = \left(\frac{511}{5} - 10.22 \right) k\Omega$$

$$R_{trim-down} = 91.98k\Omega$$



CHB200W Series Application Note V15

Connecting an external resistor ($R_{trim-up}$) between the Trim pin and the V_{out} (+) (or Sense (+)) pin increases the output voltage. The following equations determine the required external resistor value to obtain a up percentage output voltage change of $\Delta\%$.

For V_o : 3.3, 5, 12, 15, 24, 28V

$$R_{trim-up} = \left[\frac{5.11V_{out}(100 + \Delta\%)}{1.225 \times \Delta\%} - \frac{511}{\Delta\%} - 10.22 \right] k\Omega$$

For V_o : 48V

$$R_{trim-up} = \left[\frac{20V_{out}(100 + \Delta\%)}{1.225 \times \Delta\%} - \frac{2000}{\Delta\%} - 40 \right] k\Omega$$

Where

$$V_{out} = V_{o,set}, \Delta\% = \left(\frac{V_{desired} - V_{o,set}}{V_{o,set}} \right) \times 100$$

For example, to trim-up the output voltage of 12V module (CHB200W-48S12) by 5% to 12.6V, $R_{trim-up}$ is calculated as follow:

$\Delta\%=5$

$$R_{trim-up} = \left(\frac{5.11 \times 12 \times (100 + 5)}{1.225 \times 5} - \frac{511}{5} - 10.22 \right) k\Omega$$

$$R_{trim-up} = 938.78k\Omega$$

The typical value of $R_{trim-up}$

Trim up %	3.3V	5V	12V	15V	24V	28V	48V
	$R_{trim-up}$ (K Ω)						
1%	869.1	1585.4	4534.6	5798.5	9590.3	11275.6	77111
2%	436.3	798	2287.2	2925.4	4840.1	5691.1	38927.3
3%	292.1	535.5	1538.1	1967.7	3256.7	3829.6	26199.5
4%	219.9	404.3	1163.5	1488.9	2465	2898.8	19835.5
5%	176.7	325.6	938.8	1201.6	1990	2340.4	16017.1
6%	147.8	273.1	789	1010	1673.3	1968.1	13471.6
7%	127.2	235.6	681.9	873.2	1447.1	1702.2	11653.3
8%	111.7	207.5	601.7	770.6	1277.4	1502.7	10289.6
9%	99.7	185.6	539.2	690.8	1145.5	1347.6	9228.9
10%	90.1	168.1	489.3	627	1039.9	1223.5	8380.4

The typical value of $R_{trim-down}$

Trim down %	3.3V	5V	12V	15V	24V	28V	48V
	$R_{trim-down}$ (K Ω)						
1%	500.8	500.8	500.8	500.8	500.8	500.8	1960
2%	245.3	245.3	245.3	245.3	245.3	245.3	960
3%	160.1	160.1	160.1	160.1	160.1	160.1	626.7
4%	117.5	117.5	117.5	117.5	117.5	117.5	460
5%	92	92	92	92	92	92	360
6%	74.9	74.9	74.9	74.9	74.9	74.9	293.3
7%	62.8	62.8	62.8	62.8	62.8	62.8	245.7
8%	53.7	53.7	53.7	53.7	53.7	53.7	210
9%	46.6	46.6	46.6	46.6	46.6	46.6	182.2
10%	40.9	40.9	40.9	40.9	40.9	40.9	160

Method 2

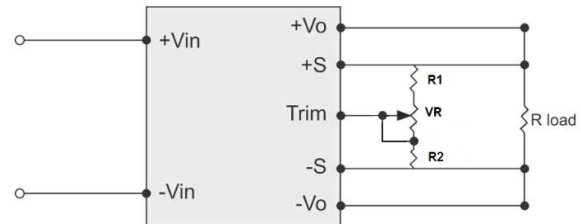

Output Voltage Trim Circuit Configuration with VR

Recommend Resistor Values:

V_{out} (V)	$R1$ (K Ω)	$R2$ (K Ω)	VR (K Ω)
3.3	9.1	7.5	10
5	13.7	5.6	10
12	30	4.3	20
15	36	3.9	20
24	43	2.7	20
28	51	2.67	20
48	68	2	20

For CHB200W-xxS3V3, 05, 12, 15, 24, 28

$$R1 + VR \geq \frac{37.543 \times R2 \times V_o - 40.88 \times R2}{40.88 - R2} (K\Omega) \dots \dots \dots (1)$$

$$R1 \leq \frac{45.886 \times R2 \times V_o - 61.32 \times R2}{61.32 + R2} (K\Omega) \dots \dots \dots (2)$$

$$VR \geq (1) - (2)$$

For CHB200W-xxS48

$$R1 + VR \geq \frac{146.939 \times R2 \times V_o - 160 \times R2}{160 - R2} (K\Omega) \dots \dots \dots (1)$$

$$R1 \leq \frac{179.592 \times R2 \times V_o - 240 \times R2}{240 + R2} (K\Omega) \dots \dots \dots (2)$$

$$VR \geq (1) - (2)$$



CHB200W Series Application Note V15

Ex: CHB200W-24S12

If R2=4.3KΩ

$$R1 + VR \geq \frac{37.543 \times 4.3 \times 12 - 40.88 \times 4.3}{40.88 - 4.3} = 48.153K\Omega$$

$$R1 \leq \frac{45.886 \times 4.3 \times 12 - 61.32 \times 4.3}{61.32 + 4.3} = 32.064K\Omega$$

$$VR \geq 48.153 - 32.064 = 16.089K\Omega$$

R1 use 30K, VR use 20K

Ex: CHB200W-24S48

If R2=2KΩ

$$R1 + VR \geq \frac{146.939 \times 2 \times 48 - 160 \times 2}{160 - 2} = 87.254K\Omega$$

$$R1 \leq \frac{179.592 \times 2 \times 48 - 240 \times 2}{240 + 2} = 69.26K\Omega$$

$$VR \geq 87.254 - 69.26 = 17.994K\Omega$$

R1 use 68K, VR use 20K

The output voltage on 28V models, see input& output trim curves for trim up and trim down is -10%.

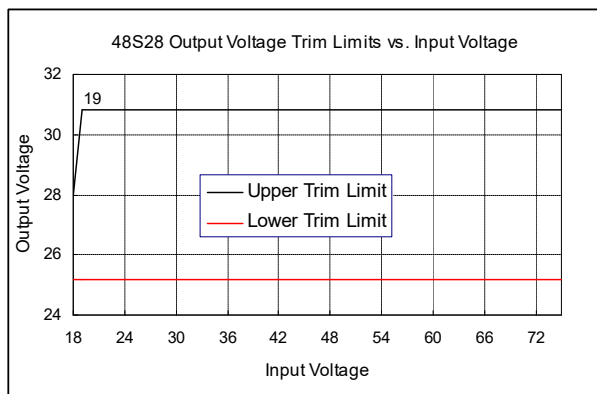
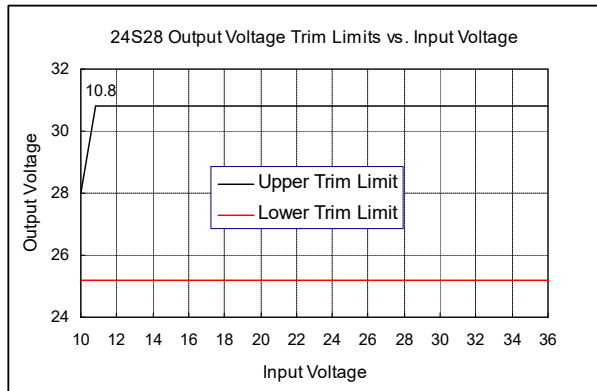

6.10 Output Remote Sensing

The CHB200W series converter has the capability to remotely sense both lines of its output. This feature moves the effective output voltage regulation point from the output of the unit to the point of connection of the remote sense pins. This feature automatically adjusts the real output voltage of the CHB200W series in order to compensate for voltage drops in distribution and maintain a regulated voltage at the point of load. The remote-sense voltage range is:

$$[(+V_{out}) - (-V_{out})] - [(+Sense) - (-Sense)] \leq 10\% \text{ of } V_{o_nominal}$$

If the remote sense feature is not to be used, the sense pins should be connected locally. The +Sense pin should be connected to the +Vout pin at the module and the -Sense pin should be connected to the -Vout pin at the module.

This is shown in the schematic below.

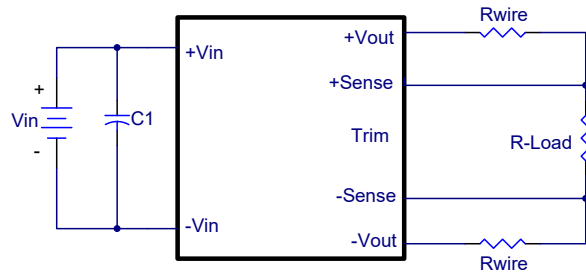

Note:

Although the output voltage can be increased by both the remote sense and by the trim, the maximum increase for the output voltage is not the sum of both. The maximum increase is the larger of either the remote sense or the trim. The amount of power delivered by the module is defined as the voltage at the output terminals multiplied by the output current. When using remote sense and trim, the output voltage of the module can be increased and consequently increase the power output of the module if output current remains unchanged. Care should be taken to ensure that the maximum output power of the module remains at or below the maximum rated

power (Maximum rated power = $V_{o,set} \times I_{o,max}$)



CHB200W Series Application Note V15

6.11 Output Ripple and Noise

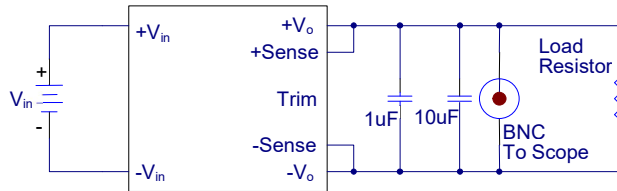

Output ripple and noise is measured with 1.0uF ceramic and 10uF solid tantalum capacitors across the output.

6.12 Output Capacitance

The CHB200W series converters provide unconditional stability with or without external capacitors. For good transient response, low ESR output capacitors should be located close to the point of load. PCB design emphasizes low resistance and inductance tracks in consideration of high current applications. Output capacitors with their associated ESR values have an impact on loop stability and bandwidth. The absolute maximum value of CHB200W series' output capacitance is 10000uF. For values larger than this, please contact your local CINCON's representative.



CHB200W Series Application Note V15

7. Safety & EMC

7.1 Input Fusing and Safety Considerations

The CHB200W series converters have no internal fuse. In order to achieve maximum safety and system protection, always use an input line fuse. We recommended a 40A time delay fuse for 24Vin models, and 20A for 48Vin models. It is recommended that the circuit have a transient voltage suppressor diode (TVS) across the input terminal to protect the unit against surge or spike voltage and input reverse voltage (as shown).

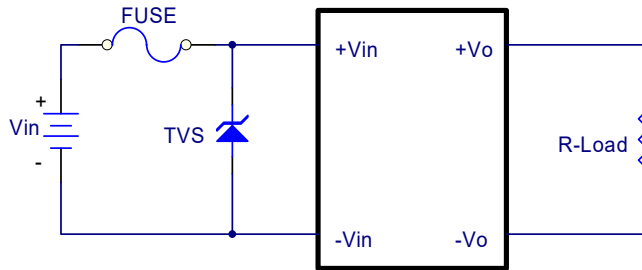

7.2 EMC Considerations

Suggested Circuits for Conducted EMI Class A

- (1) EMI and conducted noise meet EN55032 Class A specifications:
Test Condition: nominal input voltage, output at full load

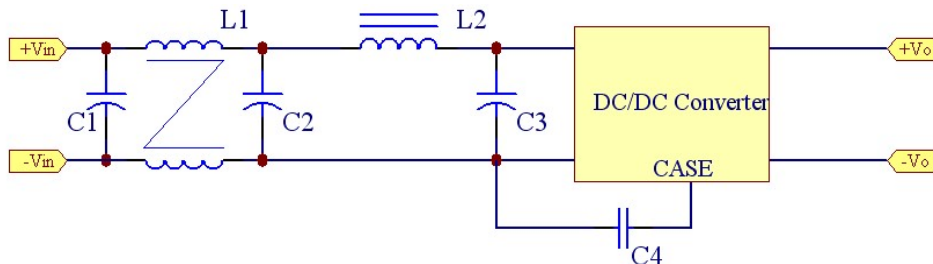

EN55032 Class A						
Model No.	C1	C2	C3	C4	L1	L2
CHB200W-24S3V3	47uF/100V	47uF/100V	NC	NC	0.5mH	Short
CHB200W-24S05	82uF/100V	82uF/100V	NC	NC	0.5mH	Short
CHB200W-24S12	120uF/100V	120uF/100V	NC	NC	0.5mH	Short
CHB200W-24S15	47uF/100V	47uF/100V	NC	NC	0.5mH	Short
CHB200W-24S24	100uF/100V	100uF/100V	NC	NC	0.5mH	Short
CHB200W-24S28	100uF/100V	100uF/100V	NC	NC	0.5mH	Short
CHB200W-48S3V3	47uF/100V	47uF/100V	NC	NC	0.1mH	Short
CHB200W-48S05	47uF/100V	47uF/100V	NC	NC	0.5mH	Short
CHB200W-48S12	82uF/100V	82uF/100V	NC	NC	0.5mH	Short
CHB200W-48S15	82uF/100V	82uF/100V	NC	NC	0.5mH	Short
CHB200W-48S24	82uF/100V	82uF/100V	NC	NC	0.7mH	Short
CHB200W-48S28	150uF/100V	150uF/100V	NC	NC	0.5mH	Short

Note: C1, C2 NIPPON CHEMI-CON KY series aluminum capacitors



CHB200W Series Application Note V15

(2) EMI and conducted noise meet EN55032 Class A specifications:

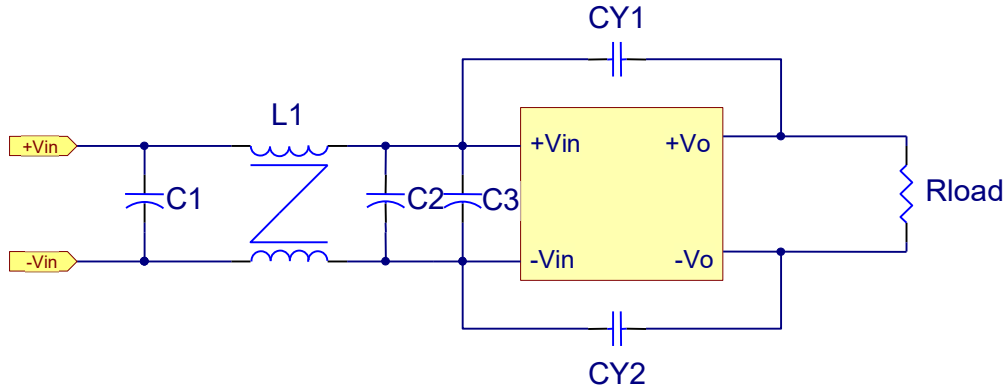

EN55032 Class A						
Model No.	C1	C2	C3	CY1	CY2	L1
CHB200W-24S48	100uF/100V	100uF/100V	100uF/100V	680pF/2KV	680pF/2KV	1.0mH
CHB200W-48S48	100uF/100V	100uF/100V	100uF/100V	680pF/2KV	680pF/2KV	1.0mH

Note: C1, C2, C3 NIPPON CHEMI-CON KY series aluminum capacitors, CY1, CY2 is ceramic capacitors



CHB200W Series Application Note V15

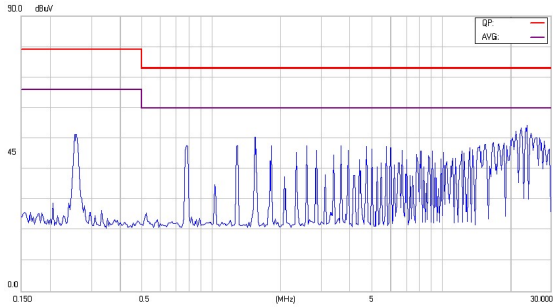

Conducted Class A of CHB200W-24S3V3

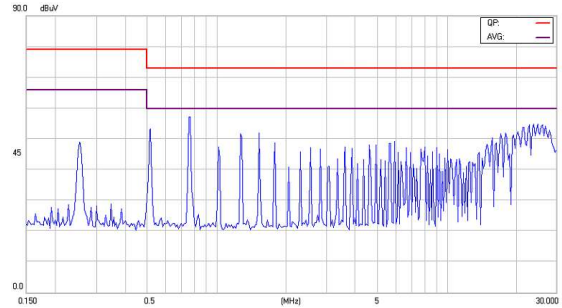

Conducted Class A of CHB200W-24S05

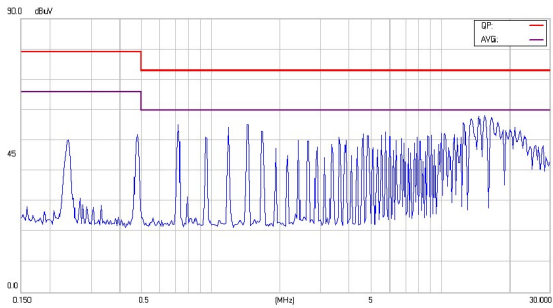

Conducted Class A of CHB200W-24S12

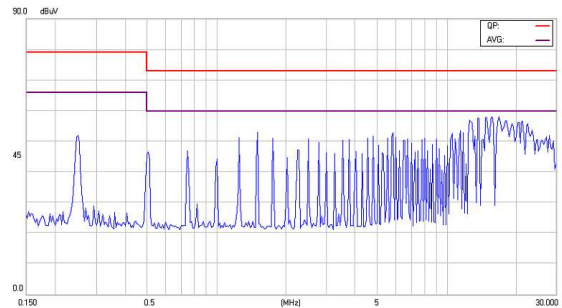

Conducted Class A of CHB200W-24S15

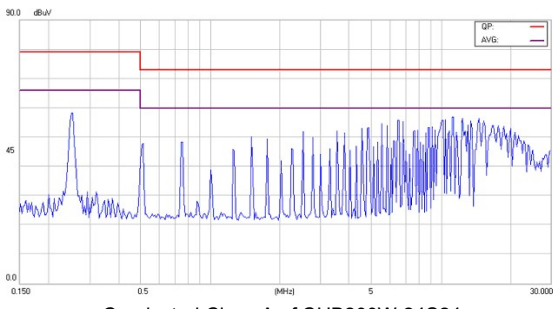

Conducted Class A of CHB200W-24S24

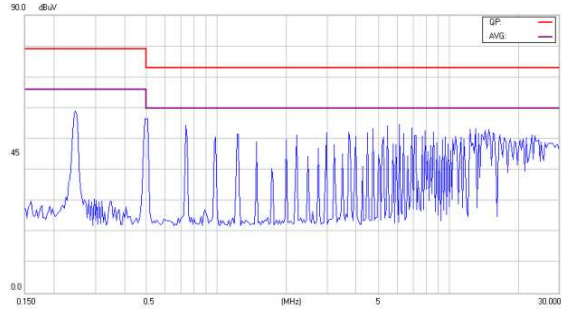

Conducted Class A of CHB200W-24S28

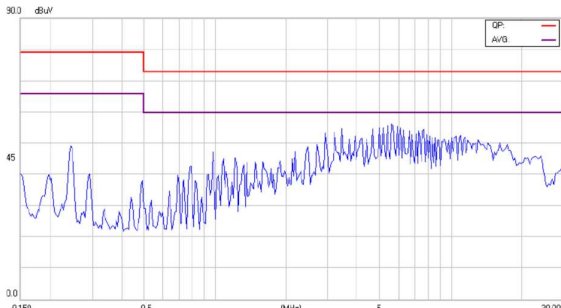

Conducted Class A of CHB200W-24S48

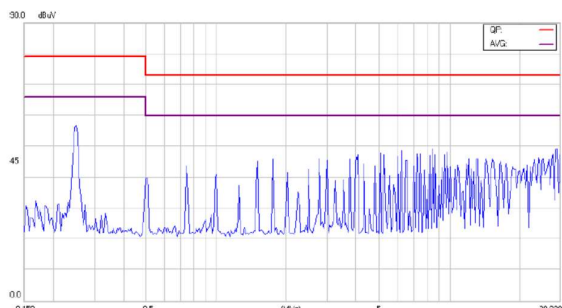

Conducted Class A of CHB200W-48S3V3



CHB200W Series Application Note V15

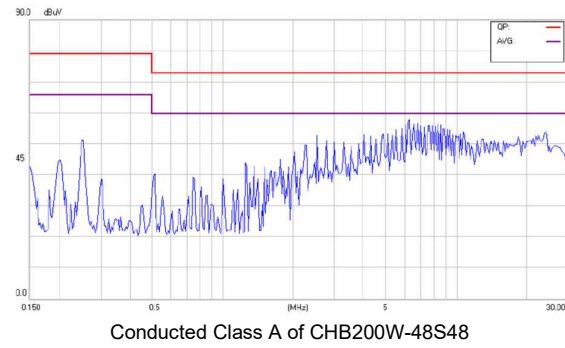
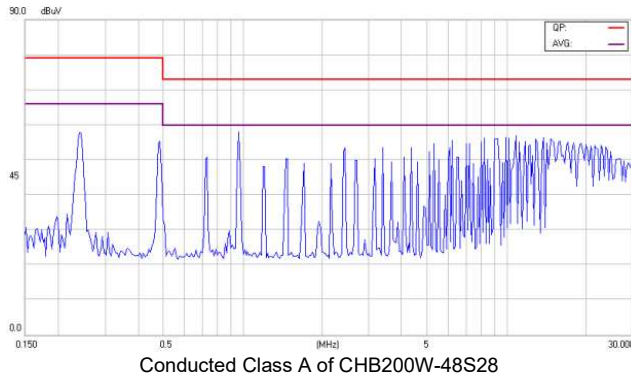
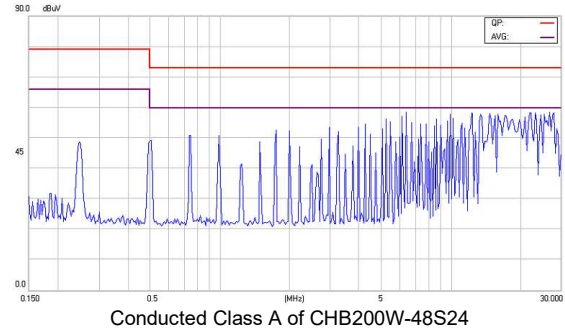
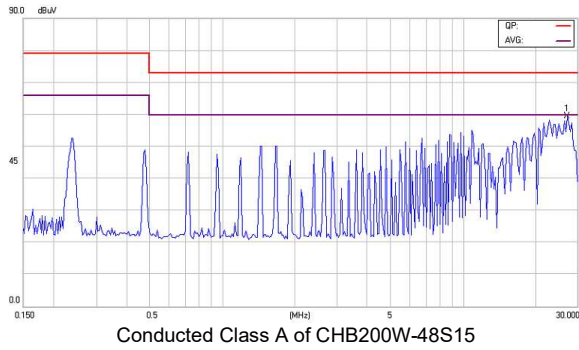
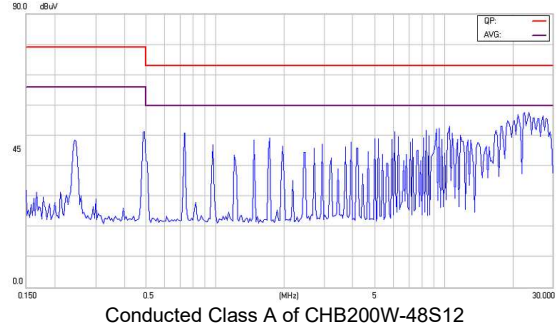
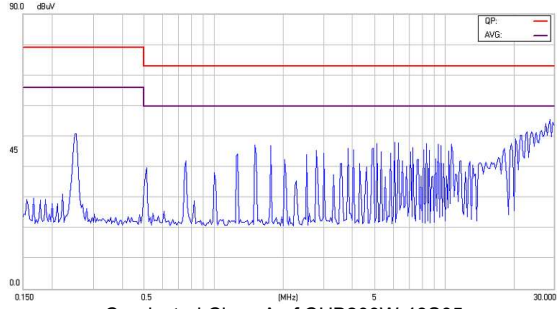



CHB200W Series Application Note V15

(2) EMI and conducted noise meet EN55032 Class B specifications:
Test Condition: nominal input voltage, output at full load

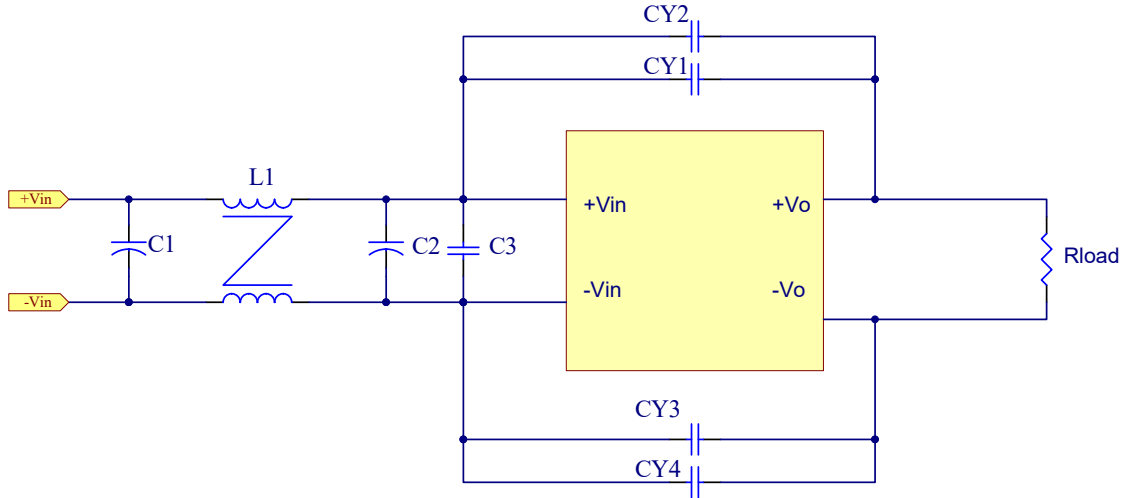

EN55032 Class B								
Model No.	C1	C2	C3	CY1	CY2	CY3	CY4	L1
CHB200W-24S24	120uF/100V	120uF/100V	10uF/50V	1000pF/2KV	NC	1000pF/2KV	NC	0.5mH
CHB200W-24S48	82uF/100V	82uF/100V	4.7uF/100V	1000pF/2KV	680pF/2KV	1000pF/2KV	680pF/2KV	0.45mH
CHB200W-48S12	120uF/100V	120uF/100V	4.7uF/100V	1000pF/2KV	NC	680pF/2KV	NC	0.5mH
CHB200W-48S48	82uF/100V	82uF/100V	4.7uF/100V	2200pF/2KV	NC	2200pF/2KV	680pF/2KV	0.45mH

Note: C1, C2 NIPPON CHEMI-CON KY series aluminum capacitors, C3, CY1, CY2, CY3, CY4 is ceramic capacitors

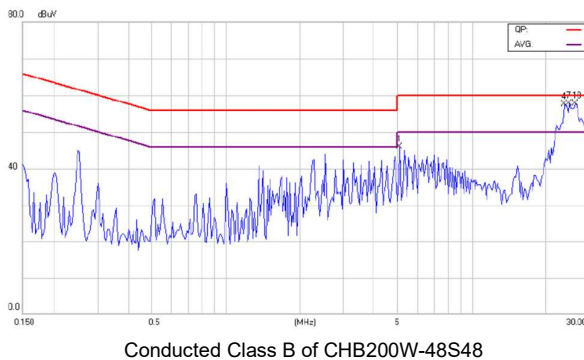
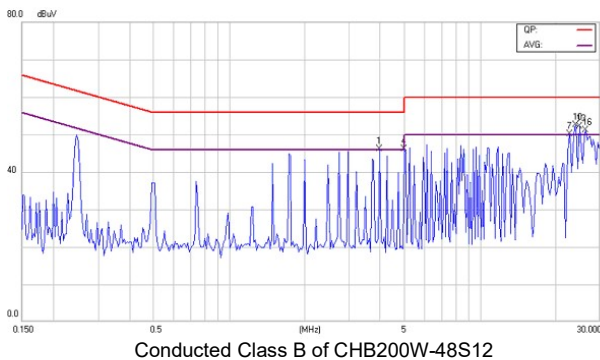
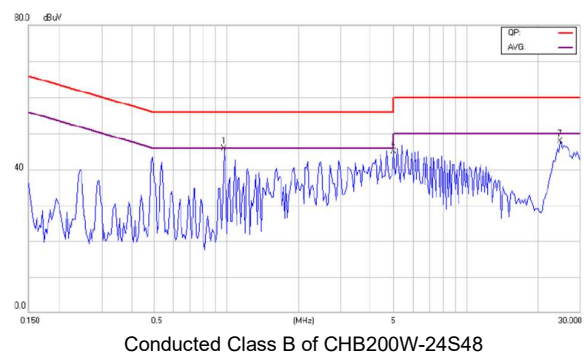
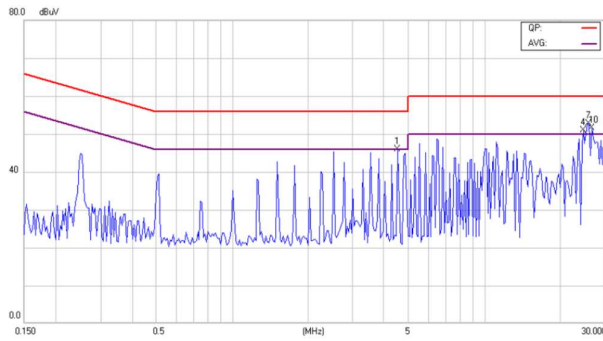



CHB200W Series Application Note V15

8. Part Number

Format: CHB200W – II X OO L–Y

Parameter	Series	Nominal Input Voltage	Number of Outputs	Output Voltage	Remote ON/OFF Logic	Mounting Inserts
Symbol	CHB200W	II	X	OO	L	Y (Option)
Value	CHB200W	24: 24 Volts 48: 48 Volts	S: Single	3V3: 3.3 Volts 05: 05 Volts 12: 12 Volts 15: 15 Volts 24: 24 Volts 28: 28 Volts 48: 48 Volts	None: N: Positive Negative	C: Clear Mounting Insert (3.2mm DIA.)

9. Mechanical Specifications

9.1 Mechanical Outline Diagrams

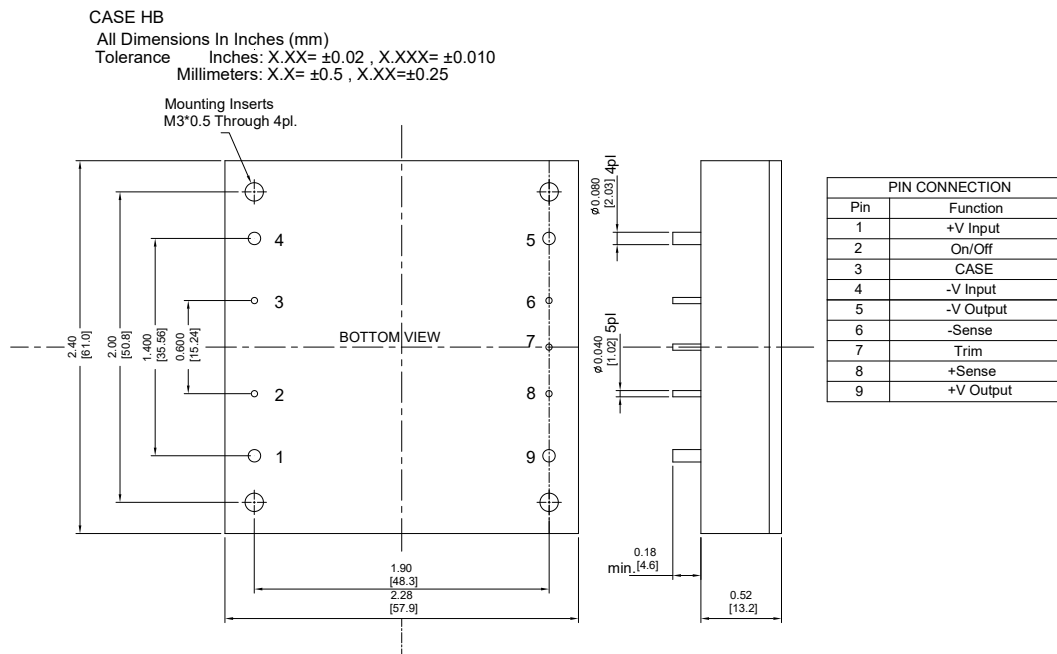

CHB200W Mechanical Outline Diagram

CINCON ELECTRONICS CO., LTD.

Headquarters:

14F, No.306, Sec.4, Hsin Yi Rd.
Taipei, Taiwan
Tel: 886-2-27086210
Fax: 886-2-27029852
E-mail: sales@cincon.com
Web Site: <https://www.cincon.com>

Factory:

No. 8-1, Fu Kung Rd.
Fu Hsing Industrial Park
Fu Hsing Hsiang,
ChangHua Hsien, Taiwan
Tel: 886-4-7690261
Fax: 886-4-7698031

Cincon North America:

1655Mesa Verde Ave. Ste 180
Ventura, CA93003
Tel: 805-639-3350
Fax: 805-639-4101
E-mail: info@cincon.com