



CEB100W-24(48)SXX Series Application Note V11

ISOLATED DC-DC CONVERTER CEB100W-24(48)SXX SERIES APPLICATION NOTE



Approved By:

Department	Approved By	Checked By	Written By
Research and Development Department	Jacky	Astray	James
Design Quality Department	Benny	JoJo	



CEB100W-24(48)SXX Series Application Note V11

Contents

1. Introduction	3
2. Pin Function Description	3
3. Connection for Standard Use	4
4. Test Set-Up	4
5. Recommend Layout, PCB Footprint and Soldering Information.....	5
6. Features and Functions	5
6.1 UVLO (Under Voltage Lock Out)	5
6.2 Over Current/Short Circuit Protection	5
6.3 Output Over Voltage Protection	6
6.4 Over Temperature Protection.....	6
6.5 Remote On/Off	6
6.6 Output Remote Sensing.....	7
6.7 Output Voltage Adjustment	8
7. Input / Output Considerations	9
7.1 Input Capacitance at the Power Module	9
7.2 Output Ripple and Noise	10
7.3 Output Capacitance	10
8. Series and Parallel Operation	10
8.1 Series Operation	10
8.2 Parallel Operation	11
8.3 Redundant Operation.....	11
9. Thermal Design.....	12
9.1 Operating Temperature Range	12
9.2 Convection Requirements for Cooling	12
9.3 Thermal Considerations	12
9.4 Power Derating	12
9.5 Eighth Brick Heat Sinks.....	14
10. Safety & EMC	14
10.1 Input Fusing and Safety Considerations	14
10.2 EMC Considerations	14



CEB100W-24(48)SXX Series Application Note V11

1. Introduction

The CEB100W series of DC-DC converters offers 100 watts of output power @ single output voltages of 05, 12, 24, 48, 54VDC with industry standard Eighth-brick. It has a wide (4:1) input voltage range of 9 to 40VDC (24VDC nominal) ,16.5 to 75VDC (48VDC nominal) and 3000VDC isolation.

Compliant with EN 55035/EN 55032, EN 45545. High efficiency up to 93.5%, allowing case operating temperature range of -40 °C to 105°C. An optional heat sink is available to extend the full power range of the unit. Low no load power consumption (125mA), an ideal solution for energy critical systems.

The standard control functions include remote on/off (positive or negative) and adjustable output voltage.

Fully protected against input UVLO (under voltage lock out), output over-current, output over-voltage and over-temperature and continuous short circuit conditions.

CEB100W series is designed suitable for distributed power architectures, telecommunications, battery operated equipment, industrial and mobile equipment application.

2. Pin Function Description

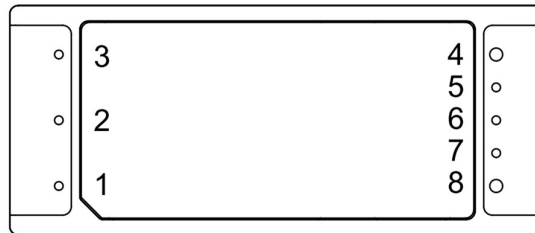

No	Label	Function	Description	Reference
1	+Vin	+V Input	Positive Supply Input	Section 7.1
2	ON/OFF	On/Off	External Remote On/Off Control	Section 6.5
3	-Vin	-V Input	Negative Supply Input	Section 7.1
4	-Vo	-V Output	Negative Power Output	Section 7.2/7.3
5	-Sen	-Sense	Negative Output Remote Sense	Section 6.6
6	Trim	Trim	External Output Voltage Adjustment	Section 6.7
7	+Sen	+Sense	Positive Output Remote Sense	Section 6.6
8	+Vo	+V Output	Positive Power Output	Section 7.2/7.3



CEB100W-24(48)SXX Series Application Note V11

3. Connection for Standard Use

The connection for standard use is shown below. An external input capacitor (C1) 470uF for 24Vin models and 220uF for 48Vin models are recommended to reduce input ripple voltage. External output capacitors (C2, C3) are recommended to reduce output ripple and noise, 10uF polymer tantalum and 1uF ceramic capacitor for all models.

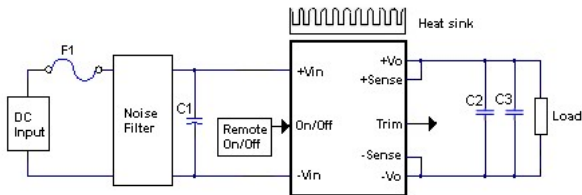

Symbol	Component	Reference
F1	Input fuse	Section 10.1
C1	External capacitor on input side	Note Section 7.1
C2, C3	External capacitor on the output side	Section 7.2/7.3
Noise Filter	External input noise filter	Section 10.2
Remote On/Off	External Remote On/Off control	Section 6.5
Trim	External output voltage adjustment	Section 6.7
Heat Sink	External heat sink	Section 9.2/9.3/9.4/9.5
+Sense/-Sense	--	Section 6.6

Note:

If the impedance of input line is high, C1 capacitance must be more than above. Use more than two recommended capacitor above in parallel when ambient temperature becomes lower than -20°C.

4. Test Set-Up

The basic test set-up to measure parameters such as efficiency and load regulation is shown below. When testing the modules under any transient conditions please ensure that the transient response of the source is sufficient to power the equipment under test. We can calculate:

- Efficiency
- Load regulation and line regulation

The value of efficiency is defined as:

$$\eta = \frac{V_o \times I_o}{V_{in} \times I_{in}} \times 100\%$$

Where:

V_o is output voltage,

I_o is output current,

V_{in} is input voltage,

I_{in} is input current

The value of load regulation is defined as:

$$Load\ reg. = \frac{V_{FL} - V_{NL}}{V_{NL}} \times 100\%$$

Where:

V_{FL} is the output voltage at full load.

V_{NL} is the output voltage at no load.

The value of line regulation is defined as:

$$Line\ reg. = \frac{V_{HL} - V_{LL}}{V_{LL}} \times 100\%$$

Where:

V_{HL} is the output voltage of maximum input voltage at full load.

V_{LL} is the output voltage of minimum input voltage at full load.

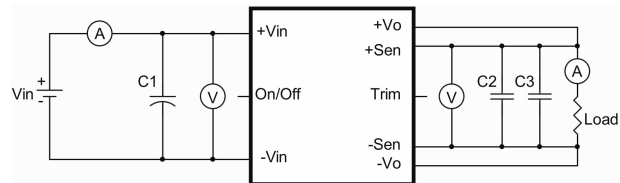

CEB100W Series Test Setup

C1: 470uF/100V ESR<0.076Ω

C2: 1uF/1210 ceramic capacitor

C3: 10uF polymer tantalum and 1uF ceramic capacitor



CEB100W-24(48)SXX Series Application Note V11

5. Recommend Layout, PCB Footprint and Soldering Information

The system designer or end user must ensure that metal and other components in the vicinity of the converter meet the spacing requirements for which the system is approved. Low resistance and inductance PCB layout traces are the norm and should be used where possible. Due consideration must also be given to proper low impedance tracks between power module, input and output grounds.

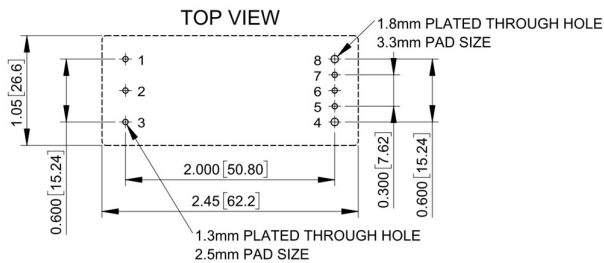

Clean the soldered side of the module with a brush, prevent liquid from getting into the module. Do not clean by soaking the module into liquid. Do not allow solvent to come in contact with product labels or resin case as this may change the color of the resin case or cause deletion of the letters printed on the product label. After cleaning, dry the modules well.

The suggested soldering iron is 450°C for up to 5seconds (less than 50W). Furthermore, the recommended soldering profile is shown below, and PCB layout is referring to Section 10.2.

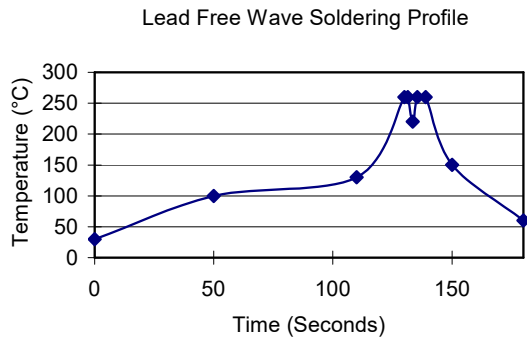

6. Features and Functions

6.1 UVLO (Under Voltage Lock Out)

Input under voltage lockout is standard on the CEB100W series unit. The unit will shut down when the input voltage drops below a threshold, and the unit will operate when the input voltage goes above the upper threshold.

CEB100W-24SXX
I_{in} Vs V_{in}

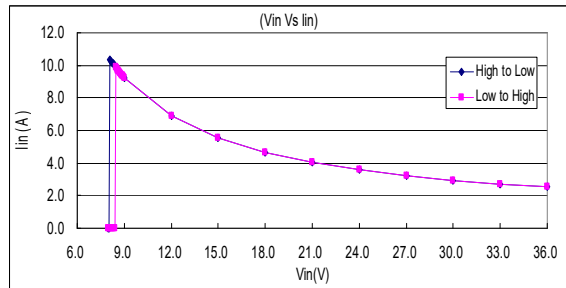

CEB100W-48SXX
I_{in} Vs V_{in}

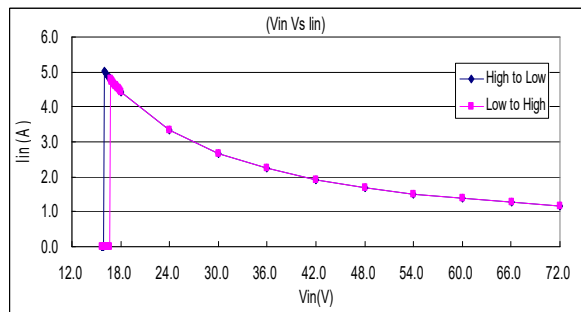

6.2 Over Current/Short Circuit Protection

All models have internal over current and continuous short circuit protection. The unit operates normally once the fault condition is removed. At the point of current limit inception, the converter will go into hiccup mode protection.

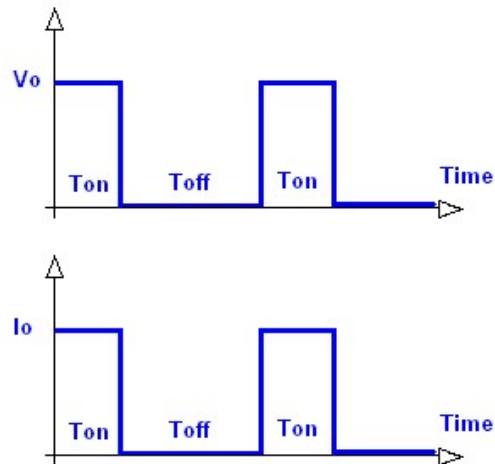



CEB100W-24(48)SXX Series Application Note V11

6.3 Output Over Voltage Protection

The output over voltage protection consists of circuitry that internally limits the output voltage. If more accurate output over voltage protection is required, then an external circuit can be used via the remote on/off pin.

Note: Please note that device inside the power supply might fail when voltage more than rate output voltage is applied to output pin. This could happen when the customer tests the over voltage protection of unit. OVP can be tested by using the TRIM UP function. Consult us for more information.

6.4 Over Temperature Protection

These modules have an over temperature protection circuit to safeguard against thermal damage. Shutdown occurs with the maximum case reference temperature is exceeded. The module will restart when the case temperature falls below over temperature recovery threshold. Please measure case temperature of the center part of aluminum base plate.

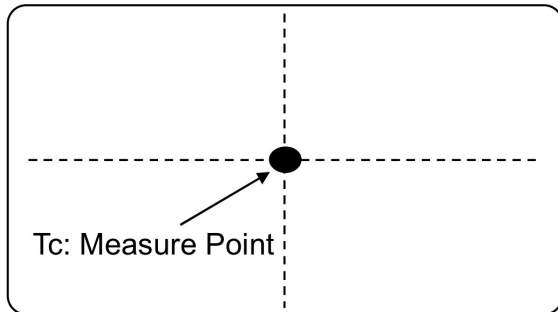
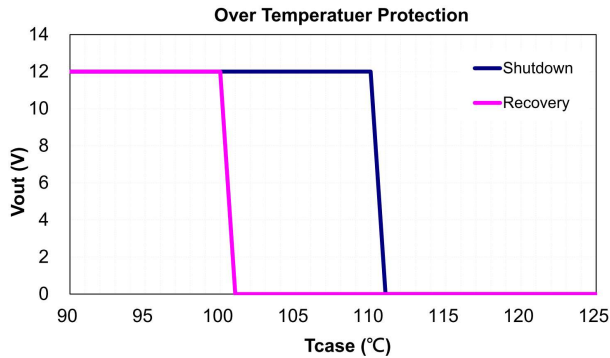

6.5 Remote On/Off

The CEB100W series allows the user to switch the module on and off electronically with the remote on/off feature. All models are available in "positive logic" and "negative logic" (optional) versions. The converter turns on if the remote on/off pin is high (>3.5Vdc to 75Vdc or open circuit). Setting the pin low (0 to <1.2Vdc) will turn the converter off. The signal level of the remote on/off input is defined with respect to ground.

If not using the remote on/off pin, leave the pin open (converter will be on).

Models with part number suffix "N" are the "negative logic" remote on/off version. The unit turns off if the remote on/off pin is high (>3.5Vdc to 75Vdc or open circuit). The converter turns on if the on/off pin input is low (0 to <1.2Vdc). Note that the converter is off by default.

Logic State (Pin 2)	Negative Logic	Positive Logic
Logic Low	Module on	Module off
Logic High	Module off	Module on

The converter remote on/off circuit built-in on input side. The ground pin of input side Remote on/off circuit is -Vin pin. Inside connection sees below.

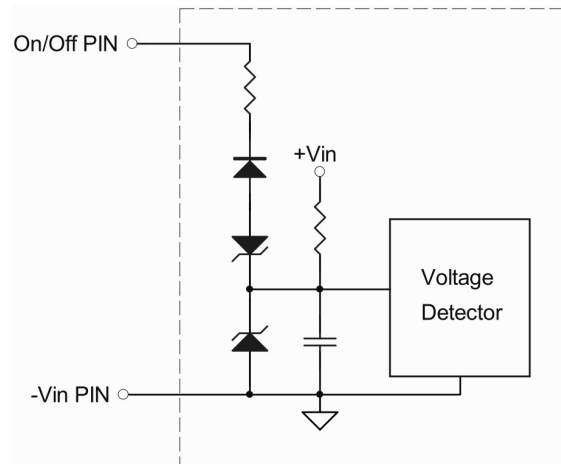

Connection examples see below.

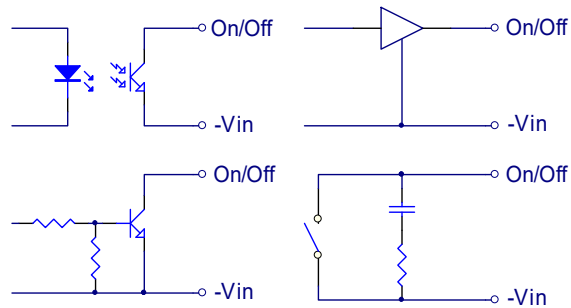

Remote On/Off Connection Example



CEB100W-24(48)SXX Series Application Note V11

6.6 Output Remote Sensing

The CEB100W series converter has the capability to remotely sense both lines of its output. This feature moves the effective output voltage regulation point from the output of the unit to the point of connection of the remote sense pins. This feature automatically adjusts the real output voltage of the CEB100W series in order to compensate for voltage drops in distribution and maintain a regulated voltage at the point of load. The remote-sense voltage range is:

For 5Vout

$$[(+V_{out}) - (-V_{out})] - [(+Sense) - (-Sense)] \leq 5\% \text{ of } V_{o_nominal}$$

For 5Vout and 48Vout

$$[(+V_{out}) - (-V_{out})] - [(+Sense) - (-Sense)] \leq 10\% \text{ of } V_{o_nominal}$$

For Others

$$[(+V_{out}) - (-V_{out})] - [(+Sense) - (-Sense)] \leq 20\% \text{ of } V_{o_nominal}$$

When remote sense is in use, the sense should be connected by twisted-pair wire or shield wire. If the sensing patterns short, heavy current flows and the pattern may be damaged. Output voltage might become unstable because of impedance of wiring and load condition when length of wire is exceeding 400mm. This is shown in the schematic below.

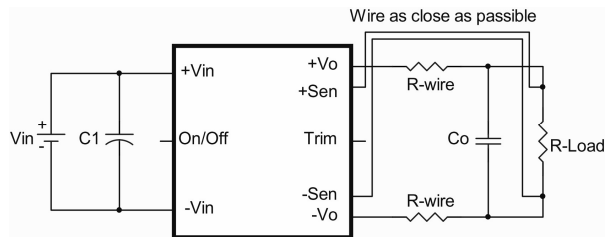

If the remote sense feature is not to be used, the sense pins should be connected locally. The +Sense pin should be connected to the +Vout pin at the module and the -Sense pin should be connected to the -Vout pin at the module. Wire between +Sense and +Vout and between -Sense and -Vout as short as possible. Loop wiring should be avoided. The converter might become unstable by noise coming from poor wiring. This is shown in the schematic below.

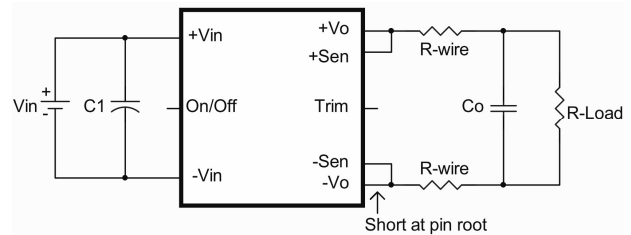

Note:

Although the output voltage can be varied (increased or decreased) by both remote sense and trim, the maximum variation for the output voltage is the larger of the two values not the sum of the values. The output power delivered by the module is defined as the voltage at the output terminals multiplied by the output current. Using remote sense and trim can cause the output voltage to increase and consequently increase the power output of the module if output current remains unchanged. Always ensure that the output power of the module remains at or below the maximum rated power. Also be aware that if V_{o_set} is below nominal value, P_{out_max} will also decrease accordingly because I_{o_max} is an absolute limit. Thus, $P_{out_max} = V_{o_set} \times I_{o_max}$ is also an absolute limit.



CEB100W-24(48)SXX Series Application Note V11

6.7 Output Voltage Adjustment

Output may be externally trimmed ($\pm 20\%$ for 12V_{out} or 24V_{out}, $-20\%/+10\%$ for 05V_{out} or 48V_{out}, and $-20\%/+5\%$ for 54V_{out}) with a fixed resistor or an external trim pot as shown (optional). Model specific formulas for calculating trim resistors are available upon request as a separate document.

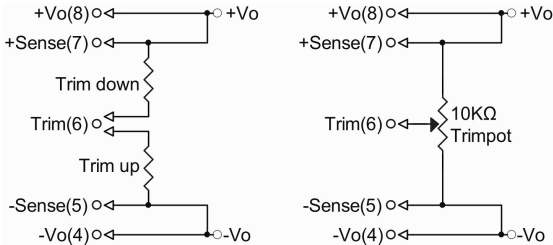

In order to trim the voltage up or down, one needs to connect the trim resistor either between the trim pin and -Sense for trim-up or between trim pin and +Sense for trim-down. The output voltage trim range are $\pm 20\%$, $-20\%/+10\%$ and $-20\%/+5\%$. This is shown:

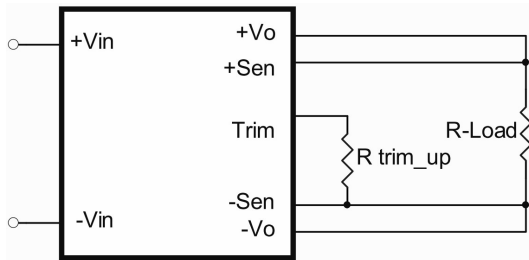

Trim-up Voltage Setup

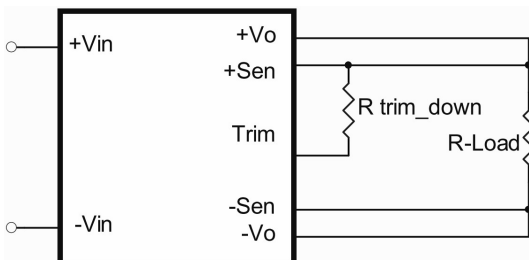

Trim-down Voltage Setup

The value of R_{trim_up} defined as:

$$R_{trim_up} = \left[\frac{V_r \times R1 \times (R2 + R3)}{R2 \times (V_o - V_{o,nom})} \right] - R_t \text{ (K}\Omega\text{)}$$

Where:

R_{trim_up} is the external resistor in K Ω

$V_{o,nom}$ is the nominal output voltage

V_o is the desired output voltage

R1, R2, R3, R_t and V_r are internal to the unit and are defined in Table 1

Table 1 – Trim up and Trim down Resistor Values

Model Number	Output Voltage(V)	R1 (K Ω)	R2 (K Ω)	R3 (K Ω)	R_t (K Ω)	V_r (V)
CEB100W-XXS05	5.0	See Note 1			1.5	2.5
CEB100W-XXS12	12.0	6.8	2.37	2.2	10	2.5
CEB100W-XXS24	24.0	15	2.42	5.9	20	2.5
CEB100W-XXS48	48.0	28.7	2.4	15	43.2	2.5
CEB100W-XXS54	54.0	36	2.42	14	51	2.5

For example, to trim-up the output voltage of 12V module (CEB100W-48S12) by 20% to 14.4V, R_{trim_up} is calculated as follows:

$$R1=6.8K\Omega, R2=2.37K\Omega, R3=2.2K\Omega, R_t=10K\Omega, V_r=2.5V, V_o=14.4V, V_{o,nom}=12V$$

$$R_{trim_up} =$$

$$\left[\frac{2.5 \times 6.8 \times (2.37 + 2.2)}{2.37 \times (14.4 - 12)} \right] - 10 = 3.66 \text{ (K}\Omega\text{)}$$

The typical value of R_{trim_up}

Trim up (%)	05V	12V	24V	48V	54V
	R_{trim_up} (K Ω)				
1%	27.90	263.17	517.19	1040.52	1079.85
2%	12.90	126.59	248.60	498.66	514.43
3%	7.90	81.06	159.06	318.04	325.95
4%	5.40	58.29	114.30	227.73	231.71
5%	3.90	44.63	87.44	173.54	175.17
6%	2.90	35.53	69.53	137.42	
7%	2.19	29.02	56.74	111.62	
8%	1.65	24.15	47.15	92.27	
9%	1.23	20.35	39.69	77.21	
10%	0.90	17.32	33.72	65.17	
11%		14.83	28.84		
12%		12.76	24.77		
13%		11.01	21.32		
14%		9.51	18.37		
15%		8.21	15.81		
16%		7.07	13.57		
17%		6.07	11.60		
18%		5.18	9.84		
19%		4.38	8.27		
20%		3.66	6.86		



CEB100W-24(48)SXX Series Application Note V11

The value of R_{trim_down} defined as:

$$R_{trim_down} = R1 \times \left[\frac{V_r \times R1}{R2 \times (V_{o,nom} - V_o)} - 1 \right] - R_t \text{ (K}\Omega\text{)}$$

Where:

R_{trim_down} is the external resistor in $K\Omega$

$V_{o,nom}$ is the nominal output voltage

V_o is the desired output voltage

$R1, R2, R3, R_t$ and V_r are internal to the unit and are defined in Table 1

For example: to trim-down the output voltage of 12V module (CEB100W-48S12) by 20% to 11.4V, R_{trim_down} is calculated as follows:

$$R1=6.8K\Omega, R2=2.37K\Omega, R3=2.2K\Omega, R_t=10K\Omega, V_r=2.5V, V_o=9.6V, V_{o,nom}=12V$$

$$R_{trim_down} = 6.8 \times \left[\frac{2.5 \times 6.8}{2.37 \times (12 - 9.6)} - 1 \right] - 10 = 3.52 \text{ (K}\Omega\text{)}$$

The typical value of R_{trim_down}

Trim down (%)	05V	12V	24V	48V	54V
	R_{trim_down} (K Ω)				
1%	86.70	389.67	933.49	1715.62	2392.34
2%	41.70	186.43	449.25	821.86	1152.67
3%	26.70	118.69	287.83	523.94	739.45
4%	19.20	84.82	207.12	374.98	532.83
5%	14.70	64.49	158.70	285.60	408.87
6%	11.70	50.94	126.42	226.02	326.22
7%	9.56	41.27	103.36	183.46	267.19
8%	7.95	34.01	86.06	151.54	222.92
9%	6.70	28.36	72.61	126.71	188.48
10%	5.70	23.85	61.85	106.85	160.93
11%	4.88	20.15	53.04	90.60	138.39
12%	4.20	17.07	45.71	77.06	119.61
13%	3.62	14.47	39.50	65.60	103.72
14%	3.13	12.23	34.18	55.78	90.10
15%	2.70	10.30	29.57	47.27	78.29
16%	2.33	8.60	25.53	39.82	67.96
17%	1.99	7.11	21.97	33.25	58.84
18%	1.70	5.78	18.81	27.41	50.74
19%	1.44	4.59	15.97	22.18	43.49
20%	1.20	3.52	13.42	17.48	36.97

Note1: CEB100W 05Vo calculated as follows:

$$R_{trim_down} = \left[\frac{1.8 \times V_r - 1.8 \times (V_o - V_{o,nom})}{(V_{o,nom} - V_o)} \right] - R_t \text{ (K}\Omega\text{)}$$

$$R_{trim_up} = \left[\frac{0.6 \times V_r - 0.6 \times (V_o - V_{o,nom})}{(V_o - V_{o,nom})} \right] - R_t \text{ (K}\Omega\text{)}$$

7. Input / Output Considerations

7.1 Input Capacitance at the Power Module

The converters must be connected to low AC source impedance. To avoid problems with loop stability source inductance should be low. Also, the input capacitors (C_{in}) should be placed close to the converter input pins to de-couple distribution inductance. However, the external input capacitors are chosen for suitable ripple handling capability. Low ESR capacitors are good choice. Circuit as shown as below represents typical measurement methods for reflected ripple current. $C1$ and $L1$ simulate a typical DC source impedance. The input reflected-ripple current is measured by current probe to oscilloscope with a simulated source Inductance ($L1$).

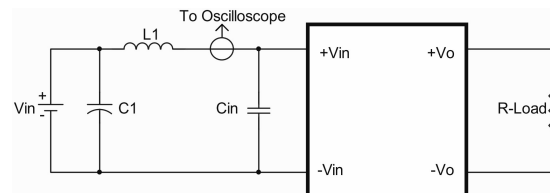

$L1$: 12 μ H

$C1$: 470 μ F, ESR < 0.076 Ω @ 20°C, 100KHz

C_{in} : 470 μ F, ESR < 0.076 Ω @ 20°C, 100KHz



CEB100W-24(48)SXX Series Application Note V11

7.2 Output Ripple and Noise

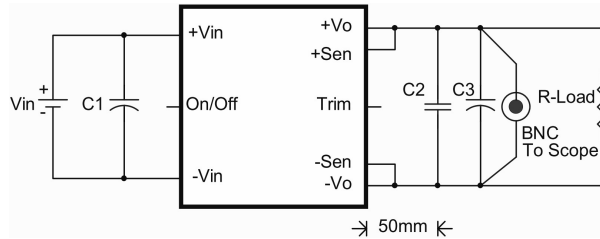

Output ripple and noise measured with 10uF polymer tantalum capacitor and 1uF ceramic capacitors across output. A 20 MHz bandwidth oscilloscope is normally used for the measurement.

The conventional ground clip on an oscilloscope probe should never be used in this kind of measurement. This clip, when placed in a field of radiated high frequency energy, acts as an antenna or inductive pickup loop, creating an extraneous voltage that is not part of the output noise of the converter.

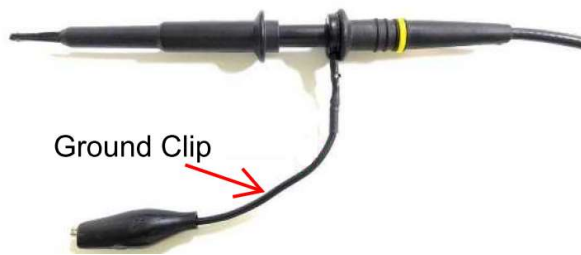

Another method is shown in below, in case of coaxial-cable/BNC is not available. The noise pickup is eliminated by pressing scope probe ground ring directly against the -Vout terminal while the tip contacts the +Vout terminal. This makes the shortest possible connection across the output terminals.

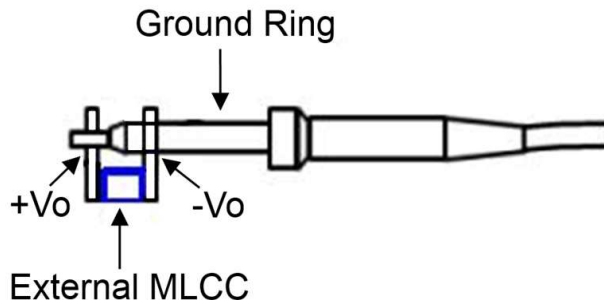

7.3 Output Capacitance

The CEB100W series converters provide unconditional stability with or without external capacitors. For good transient response, low ESR output capacitors should be located close to the point of load (<100mm). PCB design emphasizes low resistance and inductance tracks in consideration of high current applications. Output capacitors with their associated ESR values have an impact on loop stability and bandwidth. Cincon's converters are designed to work with load capacitance to see specifications.

8. Series and Parallel Operation

8.1 Series Operation

Series operation is possible by connecting the outputs two or more units. Connection is shown in below. The output current in series connection should be lower than the lowest rate current in each power module.

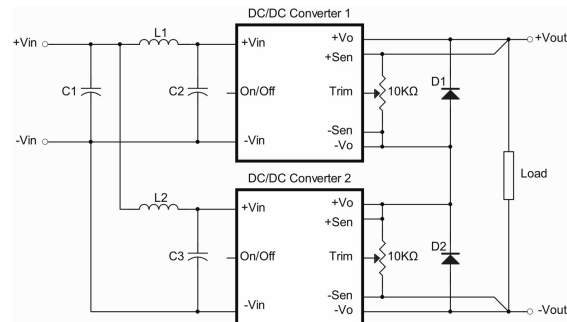

Simple Series Operation Connect Circuit

L1, L2: 1.0uH
C1, C2, C3: 470uF/100V ESR<0.076Ω

Note:

1. If the impedance of input line is high, C1, C2, C3 capacitance must be more than above. Use more than two recommended capacitor above in parallel when ambient temperature becomes lower than -20°C.
2. Recommend schottky diode (D1, D2) be connected across the output of each series connected converter, so that if one converter shuts down for any reason, then the output stage won't be thermally overstressed. Without this external diode, the output stage of the shut-down converter could carry the load current provided by the other series converters, with its MOSFETs conducting through the body diodes. The MOSFETs could then be overstressed and fail. The external diode should be capable of handling the full load current for as long as the application is expected to run with any unit shut down.



CEB100W-24(48)SXX Series Application Note V11

Series for \pm output operation is possible by connecting the outputs two units, as shown in the schematic below.

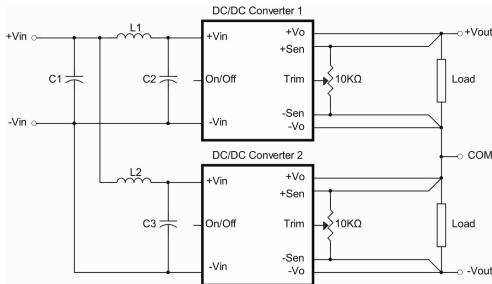

Simple \pm Output Operation Connect Circuit

L1, L2: 1.0uH
C1, C2, C3: 470uF/100V ESR<0.076Ω

Note:

If the impedance of input line is high, C1, C2, C3 capacitance must be more than above. Use more than two recommended capacitor above in parallel when ambient temperature becomes lower than -20°C.

Note:

If the impedance of input line is high, C1, C2, C3 capacitance must be more than above. Use more than two recommended capacitor above in parallel when ambient temperature becomes lower than -20°C.

8.2 Parallel Operation

The CEB100W series parallel operation is **not** possible.

8.3 Redundant Operation

Parallel for redundancy operation is possible by connecting the units as shown in the schematic below. The current of each converter become unbalance by a slight difference of the output voltage. Make sure that the output voltage of units of equal value and the output current from each power supply does not exceed the rate current. Suggest use an external potentiometer to adjust output voltage from each power supply.

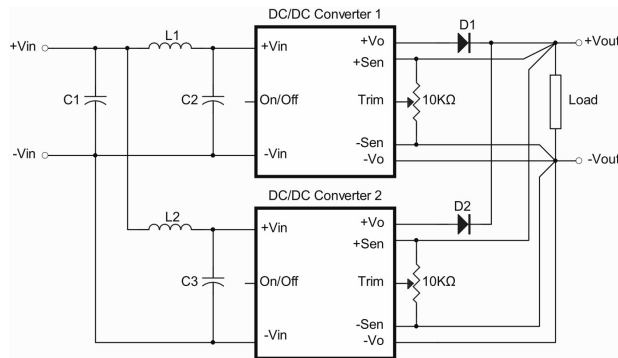

Simple Redundant Operation Connect Circuit

L1, L2: 1.0uH
C1, C2, C3: 470uF/100V ESR<0.076Ω



CEB100W-24(48)SXX Series Application Note V11

9. Thermal Design

9.1 Operating Temperature Range

The CEB100W series converters can be operated within a wide case temperature range of -40°C to 105°C. Consideration must be given to the derating curves when ascertaining maximum power that can be drawn from the converter. The maximum power drawn from open Eighth brick models is influenced by usual factors, such as:

- Input voltage range
- Output load current
- Forced air or natural convection
- Heat sink optional

9.2 Convection Requirements for Cooling

To predict the approximate cooling needed for the Eighth brick module, refer to the power derating curves in **section 9.4**. These derating curves are approximations of the ambient temperatures and airflows required to keep the power module temperature below its maximum rating. Once the module is assembled in the actual system, the module's temperature should be monitored to ensure it does not exceed 105°C as measured at the center of the top of the case (thus verifying proper cooling).

9.3 Thermal Considerations

The power module operates in a variety of thermal environments; however, sufficient cooling should be provided to help ensure reliable operation of the unit. Heat is removed by conduction, convection, and radiation to the surrounding environment. The example is presented in **section 9.4**. The power output of the module should not be allowed to exceed rated power ($V_{o_set} \times I_{o_max.}$).

9.4 Power Derating

The operating case temperature range of CEB100W series is -40°C to +105°C. When operating the CEB100W series, proper derating or cooling is needed. The maximum case temperature under any operating condition should not exceed 105°C.

The following curve is the de-rating curve of CEB100W series without heat sink.

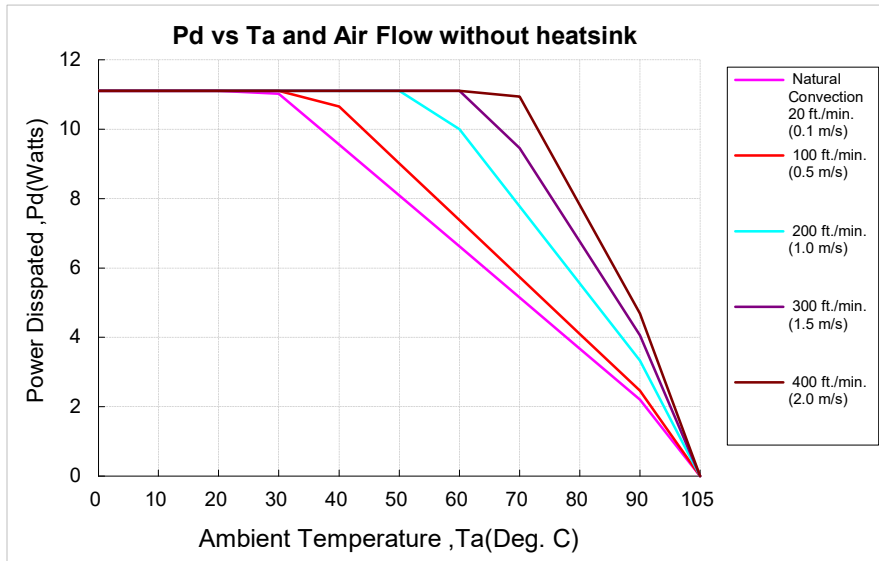

AIR FLOW RATE	TYPICAL R_{ca}
Natural Convection 20ft./min. (0.1m/s)	6.8 °C/W
100 ft./min. (0.5m/s)	6.1 °C/W
200 ft./min. (1.0m/s)	4.5 °C/W
300 ft./min. (1.5m/s)	3.7 °C/W
400 ft./min. (2.0m/s)	3.2 °C/W



CEB100W-24(48)SXX Series Application Note V11

Example:

What is the minimum airflow necessary for a CEB100W-48S12 operating at nominal line voltage, an output current of 12.5A, and a maximum ambient temperature of 40°C?

Solution:

Given: $V_{in}=48V_{dc}$, $V_o=12V_{dc}$, $I_o=8.3A$

Determine Power dissipation (P_d): $P_d=P_i-P_o=P_o(1-\eta)/\eta$, $P_d=12 \times 8.3 \times (1-0.92)/0.92=8.66\text{Watts}$

Determine airflow: Given: $P_d=8.66W$ and $T_a=40^\circ C$

Check Power Derating curve: Minimum airflow=400 ft./min.

Verify:

Maximum temperature rise is $\Delta T=P_d \times R_{ca}=8.66 \times 3.2=27.7^\circ C$

Maximum case temperature is $T_c=T_a + \Delta T=67.7^\circ C < 105^\circ C$

Where:

The R_{ca} is thermal resistance from case to ambient environment.

T_a is ambient temperature and T_c is case temperature.

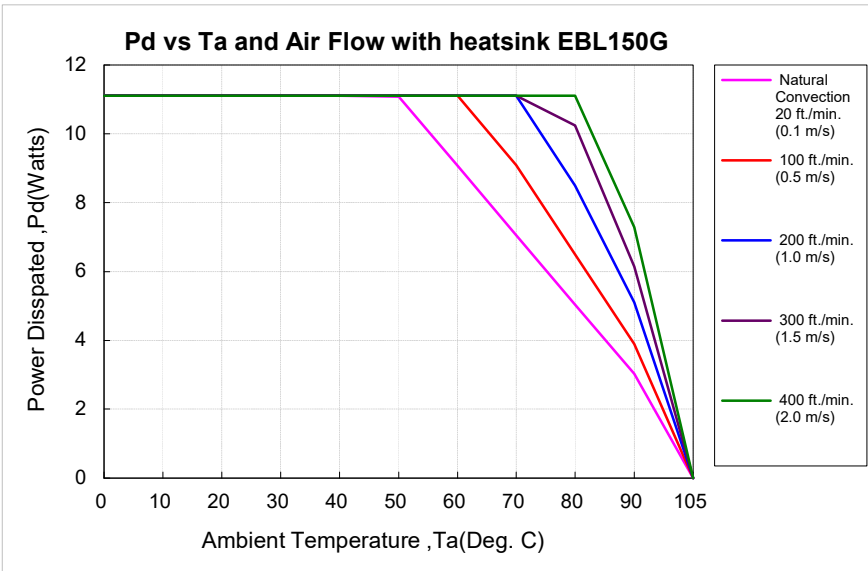

AIR FLOW RATE	TYPICAL R_{ca}
Natural Convection 20ft./min. (0.1m/s)	4.96 °C/W
100 ft./min. (0.5m/s)	3.85 °C/W
200 ft./min. (1.0m/s)	2.94 °C/W
300 ft./min. (1.5m/s)	2.44 °C/W
400 ft./min. (2.0m/s)	2.06 °C/W

Example with heat sink EBL150G:

What is the minimum airflow necessary for a CEB100W-24S05 operating at nominal line voltage, an output current of 20A, and a maximum ambient temperature of 40°C?

Solution:

Given: $V_{in}=24V_{dc}$, $V_o=5V_{dc}$, $I_o=20A$

Determine Power dissipation (P_d): $P_d=P_i-P_o=P_o(1-\eta)/\eta$, $P_d=5.0 \times 20 \times (1-0.915)/0.915=9.28\text{Watts}$

Determine airflow: Given: $P_d= 9.28W$ and $T_a = 40^\circ C$

Check above Power de-rating curve: Minimum airflow= 100 ft./min

Verify:

Maximum temperature rise is $\Delta T= P_d \times R_{ca}= 9.28 \times 3.85=35.73^\circ C$

Maximum case temperature is $T_c= T_a + \Delta T=75.7^\circ C < 105^\circ C$

Where:

The R_{ca} is thermal resistance from case to ambient environment.

T_a is ambient temperature and T_c is case temperature.



CEB100W-24(48)SXX Series Application Note V11

9.5 Eighth Brick Heat Sinks

Heat sinks assembly [refer to Datasheet-Thermal](#)

10. Safety & EMC

10.1 Input Fusing and Safety Considerations

The CEB100W series converters have no internal fuse. In order to achieve maximum safety and system protection, always use an input line fuse. We recommended a 15A time delay fuse for 24V_{in} models, and 8A for 48V_{in} models. It is recommended that the circuit have a transient voltage suppressor diode (TVS) across the input terminal to protect the unit against surge or spike voltage and input reverse voltage (as shown).

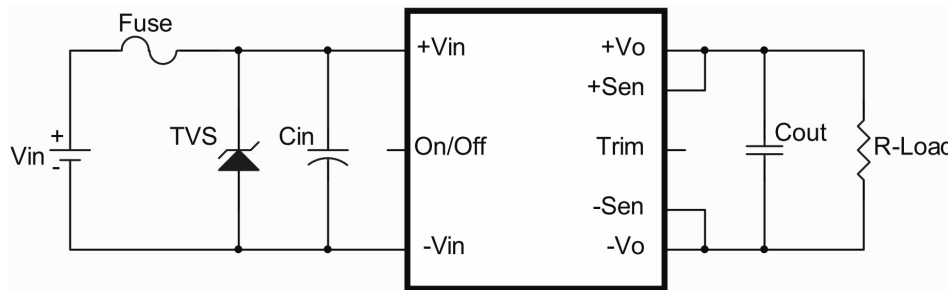

The external input capacitor (Cin) and transient voltage suppressor diode (TVS) are required if CEB100Wseries has to meet EN61000-4-4, EN61000-4-5.

The Cin recommended a 470uF/100V (Nippon Chemi-Con KY series) aluminum capacitor. And the TVS recommended SMDJ40CA for 24V_{in} models, and SMDJ78A for 48V_{in} models.

10.2 EMC Considerations

EMI Test standard: EN55032 / EN55035 Class A Conducted & Radiated Emission

Test Condition: Input Voltage: Nominal, Output Load: Full Load

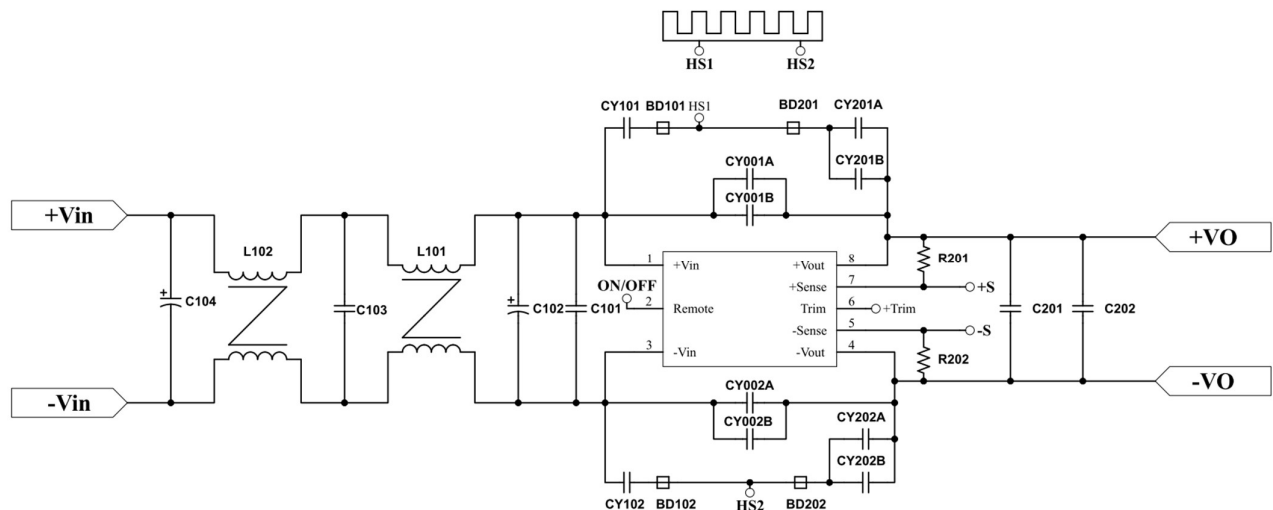
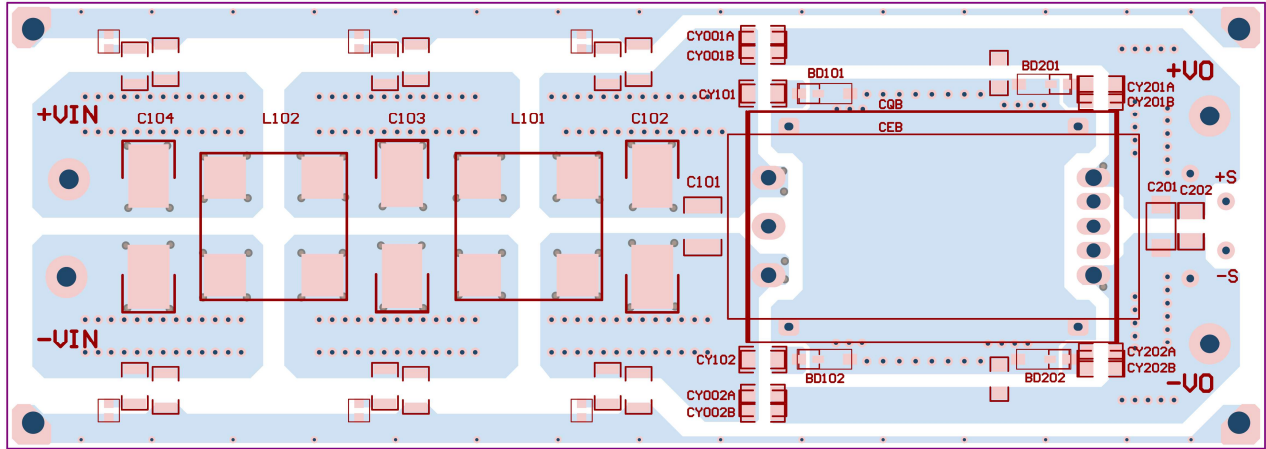

Figure1 Connection circuit for conducted EMI Class A testing



CEB100W-24(48)SXX Series Application Note V11



EMI Test Board Top Side

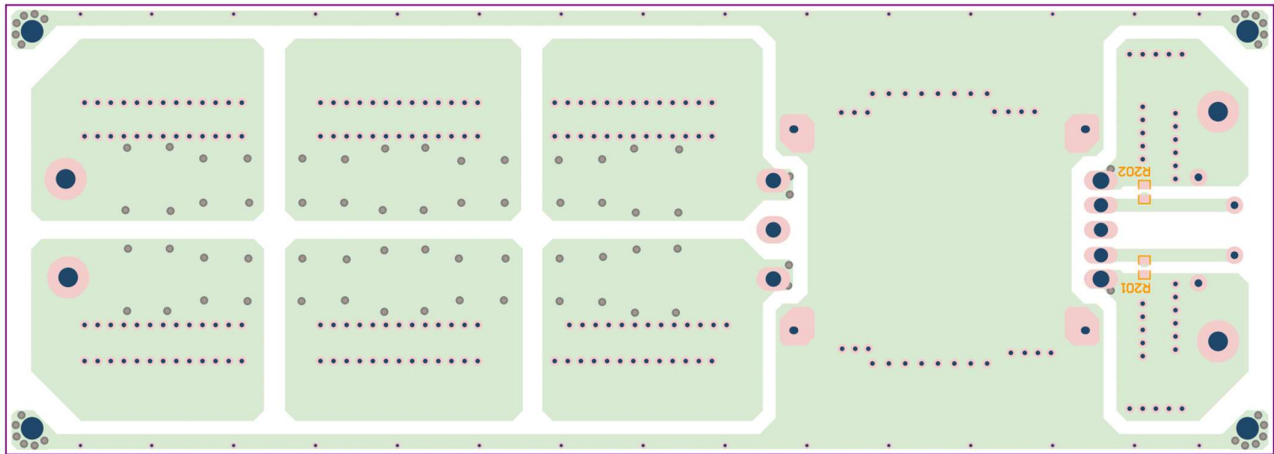

EMI Test Board Bottom Side



CEB100W-24(48)SXX Series Application Note V11

Components Value:

Model No.	L101	L102	C101	C102	C103	C104	C201	C202	R201 R202		
CEB100W-24S05	5.7mH	Jumper Wire	10uF	470uF	220uF	NC	1uF	10uF	OR		
CEB100W-24S12											
CEB100W-24S24											
CEB100W-24S48											
CEB100W-24S54											
CEB100W-48S05			4.7uF								
CEB100W-48S12											
CEB100W-48S24											
CEB100W-48S48											
CEB100W-48S54											

Model No.	CY001	CY002	CY101	CY102	CY201A	CY201B	CY202A	CY202B	BD101 BD102	BD201 BD202
CEB100W-24S05	1000pF	1000pF	NC	NC	4700pF	NC	4700pF	NC	Jumper Wire	Jumper Wire
CEB100W-24S12	2200pF	2200pF	1000pF	1000pF	4700pF		4700pF			
CEB100W-24S24	1000pF	1000pF	1000pF	1000pF	2200pF		2200pF			
CEB100W-24S48	1000pF	1000pF	2200pF	2200pF	4700pF		4700pF			
CEB100W-24S54	1000pF	1000pF	2200pF	2200pF	4700pF	4700pF	4700pF	BPH853225W4-101T-NB		
CEB100W-48S05	2200pF	2200pF	2200pF	2200pF	4700pF	NC	4700pF	NC	Jumper Wire	
CEB100W-48S12	2200pF	2200pF	2200pF	2200pF	4700pF		4700pF			
CEB100W-48S24	NC	NC	1500pF	1500pF	4700pF		4700pF			
CEB100W-48S48	1000pF	1000pF	2200pF	2200pF	2200pF		2200pF			
CEB100W-48S54	1000pF	1000pF	2200pF	2200pF	2200pF		2200pF			
									BPH853225W4-101T-NB	

Note:

- C101: 10uF /50V MLCC 2220 or equivalent
- 4.7uF/100V MLCC 2220 or equivalent
- C102: 470uF/100V KY CHEMI-CON or equivalent
- C103: 220uF/100V KY CHEMI-CON or equivalent
- C201: 10uF/100V MLCC 1812
- C202: 1uF/100V MLCC 1812
- CY001, CY002, CY101, CY102, CY201A(B), CY202A(B): 1000pF, 1500pF, 2200pF Y2 CAP. MLCC 2211, 4700pF/3KV MLCC 1808
- BD101, BD102, BD201, BD202: BPH853225W4-101T-NB TAI-TECH
- L101: T20*11*8-A(E) 0.8mm*2/10T 3.88mH~7.53mH CINCON (G91CA826015) or equivalent



CEB100W-24(48)SXX Series Application Note V11

Conducted Emission:

CEB100W-24S05

Line

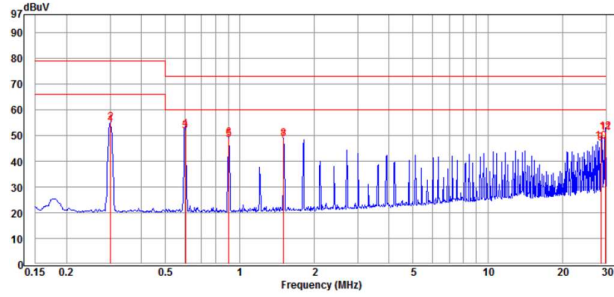

Neutral

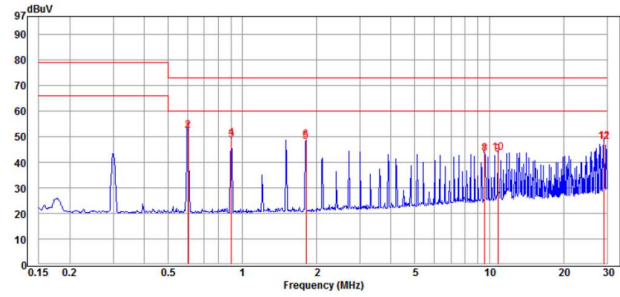

CEB100W-24S12

Line

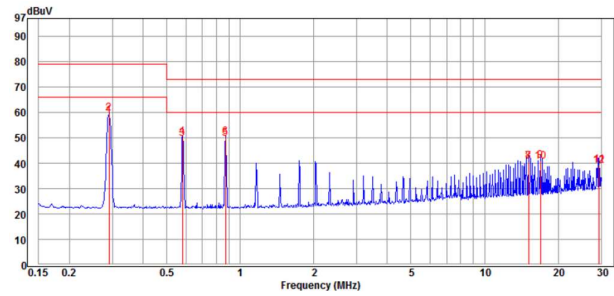

Neutral

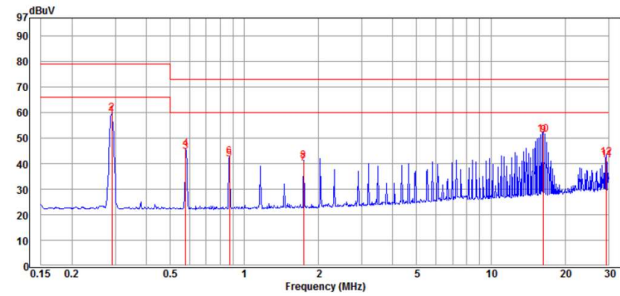

CEB100W-24S24

Line

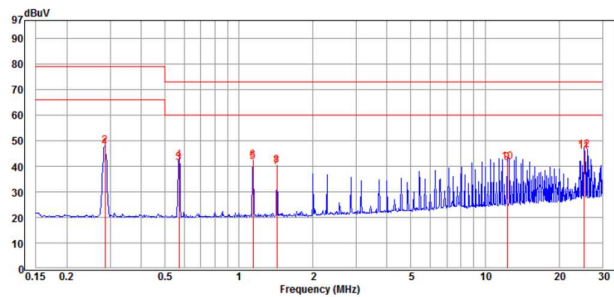

Neutral

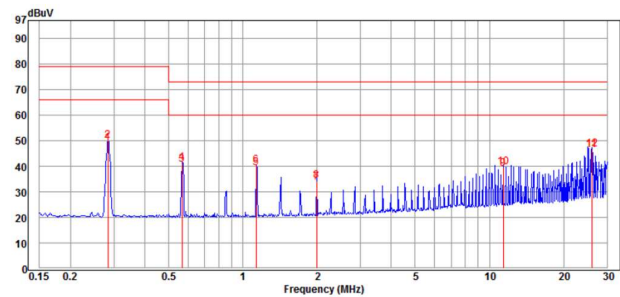



CEB100W-24(48)SXX Series Application Note V11

CEB100W-24S48

Line

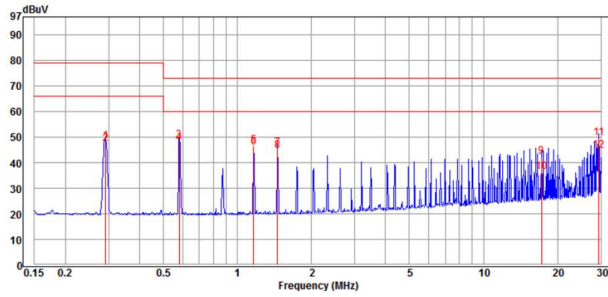

Neutral

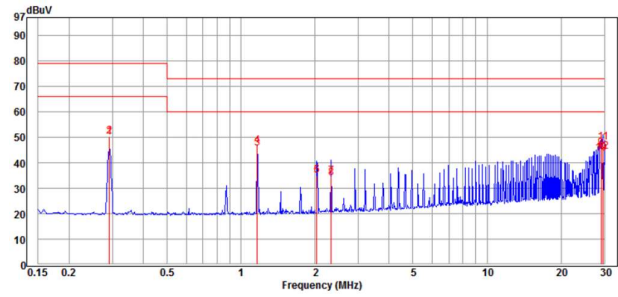

CEB100W-24S54

Line

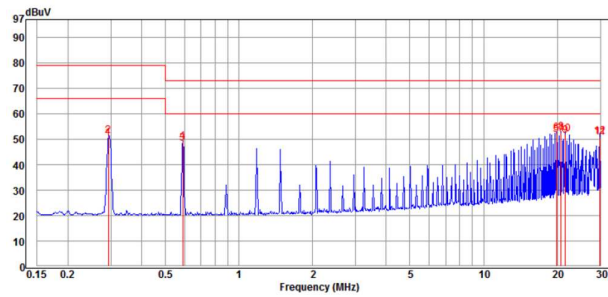

Neutral

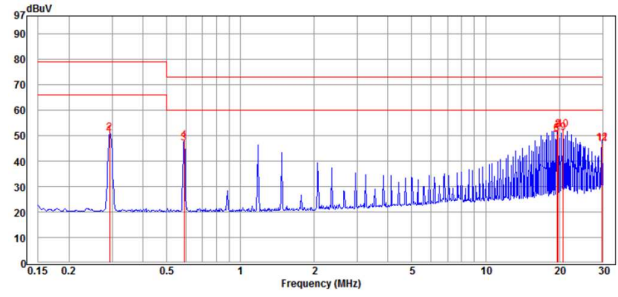

CEB100W-48S05

Line

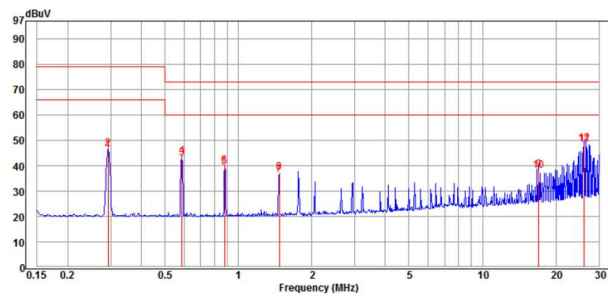

Neutral

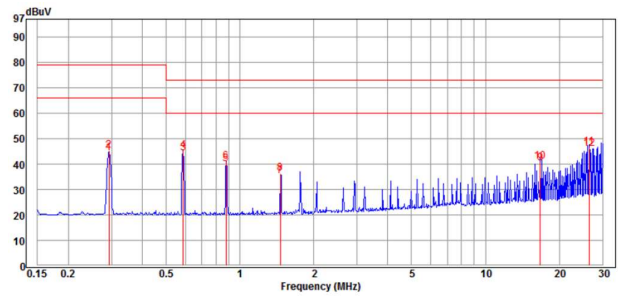



CEB100W-24(48)SXX Series Application Note V11

CEB100W-48S12

Line

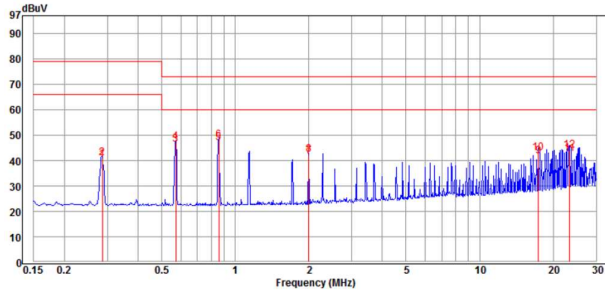

Neutral

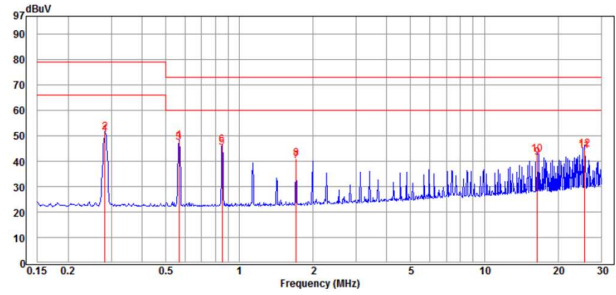

CEB100W-48S24

Line

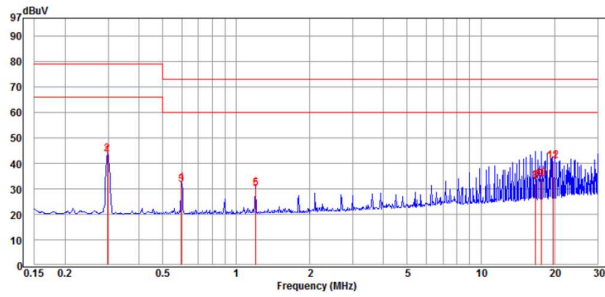

Neutral

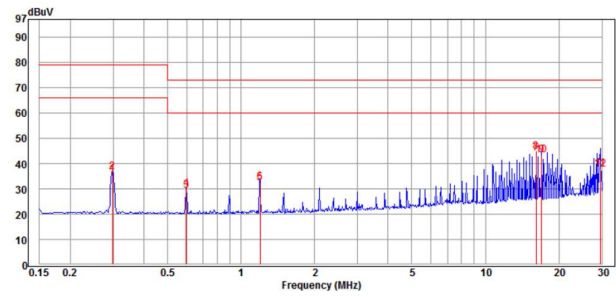

CEB100W-48S48

Line

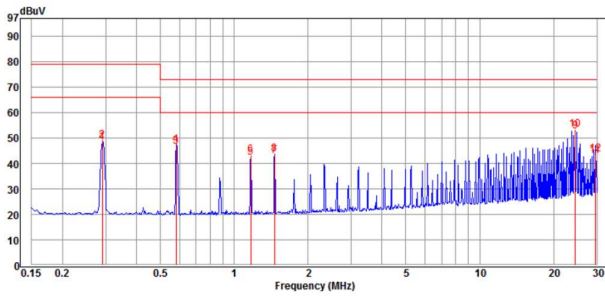

Neutral

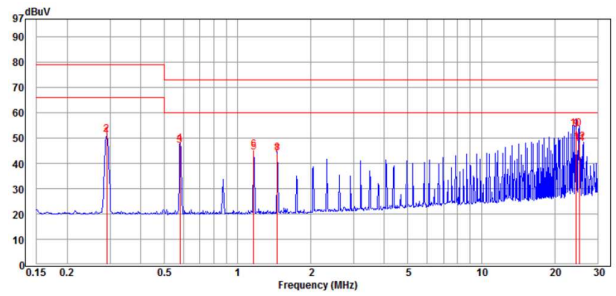



CEB100W-24(48)SXX Series Application Note V11

CEB100W-48S54

Line

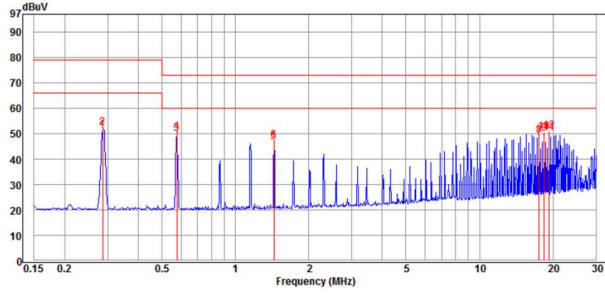

Neutral

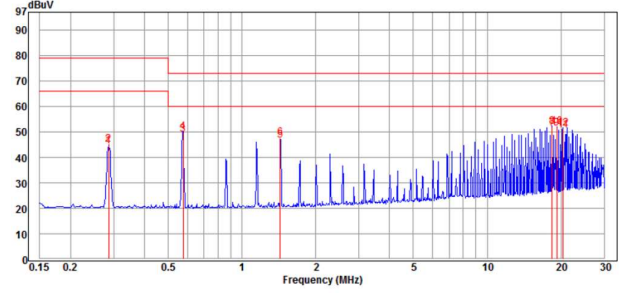

Radiated Emission:

CEB100W-24S05

Vertical

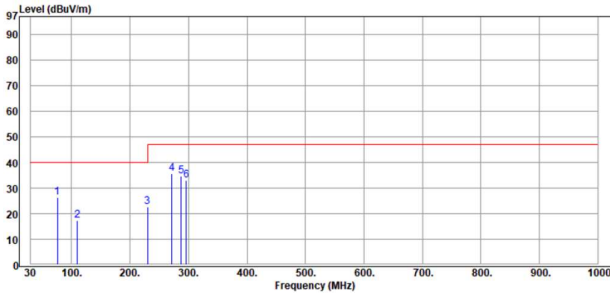

Horizontal

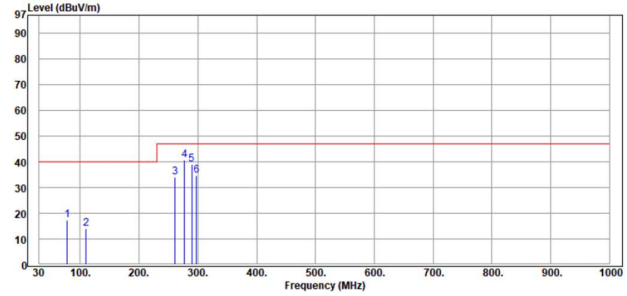

CEB100W-24S12

Vertical

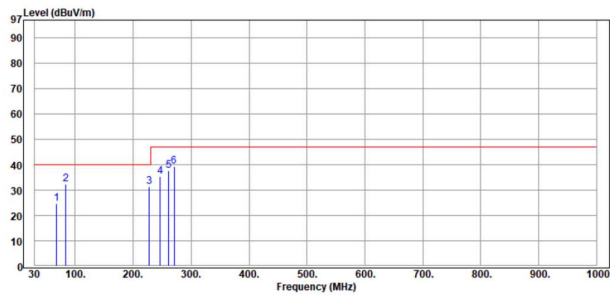

Horizontal

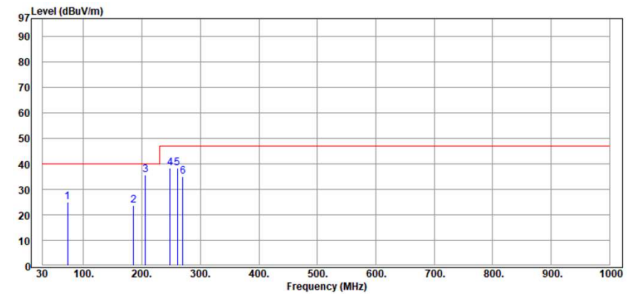



CEB100W-24(48)SXX Series Application Note V11

CEB100W-24S24

Vertical

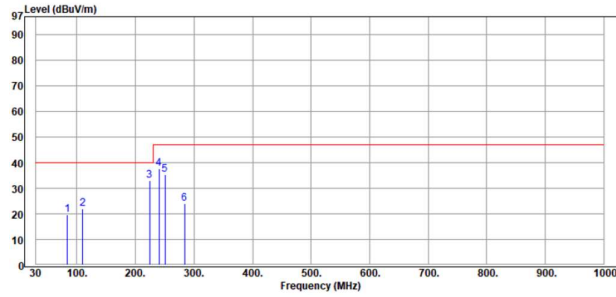

Horizontal

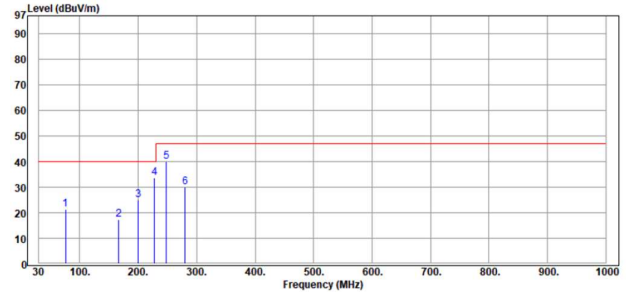

CEB100W-24S48

Vertical

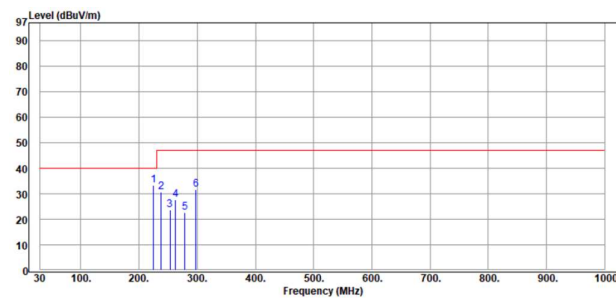

Horizontal

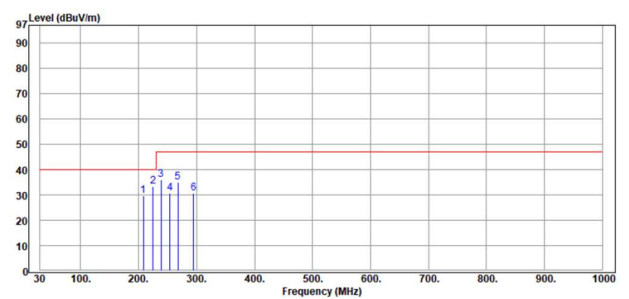

CEB100W-24S54

Vertical

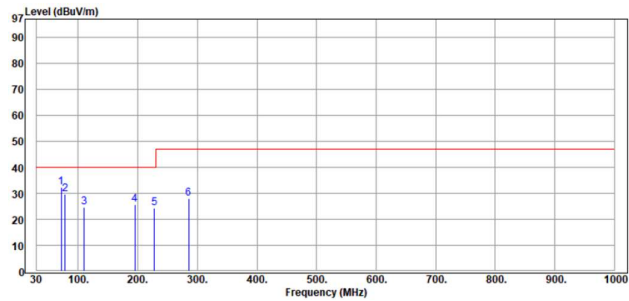

Horizontal

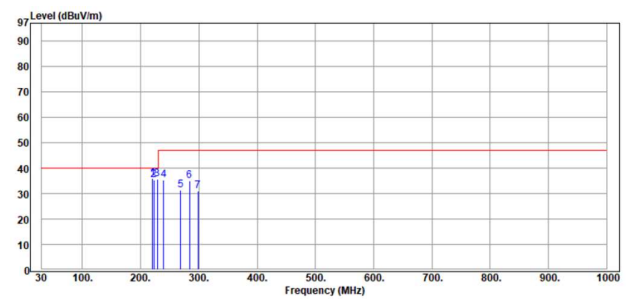

CEB100W-48S05

Vertical

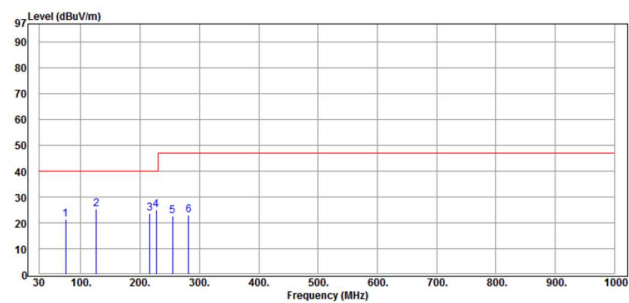

Horizontal

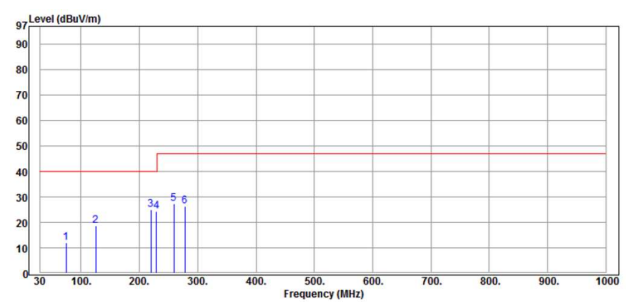



CEB100W-24(48)SXX Series Application Note V11

CEB100W-48S12

Vertical

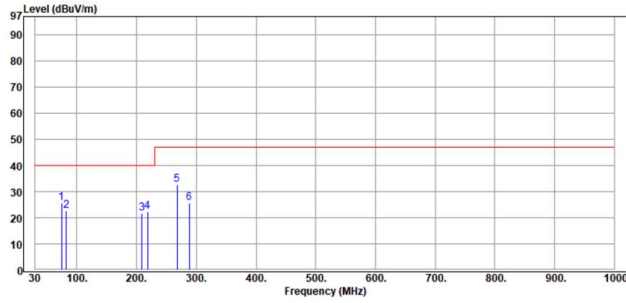

Horizontal

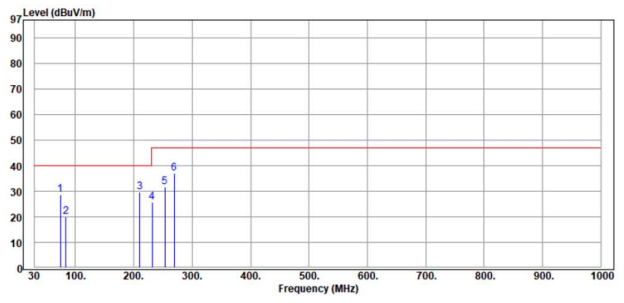

CEB100W-48S24

Vertical

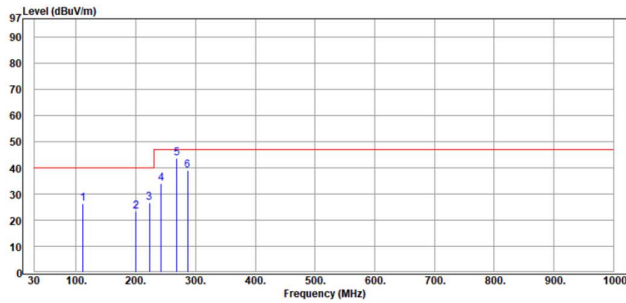

Horizontal

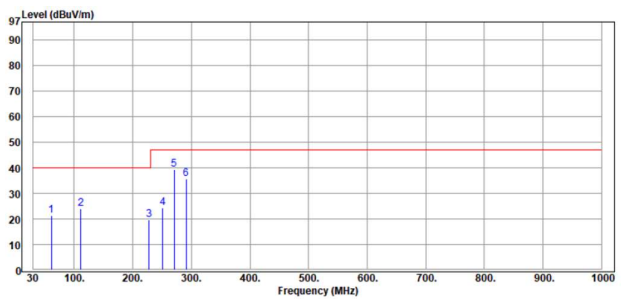

CEB100W-48S48

Vertical

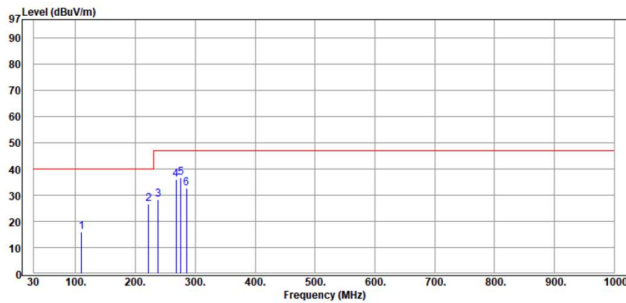

Horizontal

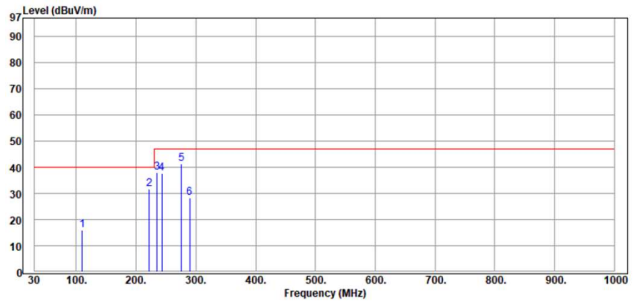



CEB100W-24(48)SXX Series Application Note V11

CEB100W-48S54

Vertical

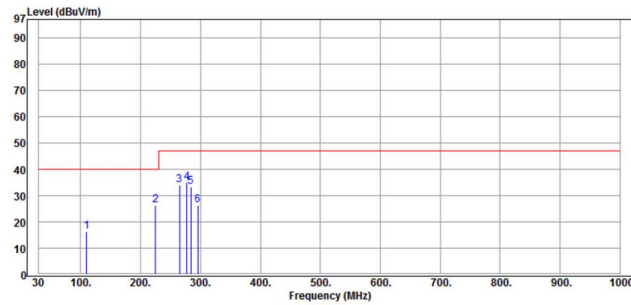

Horizontal

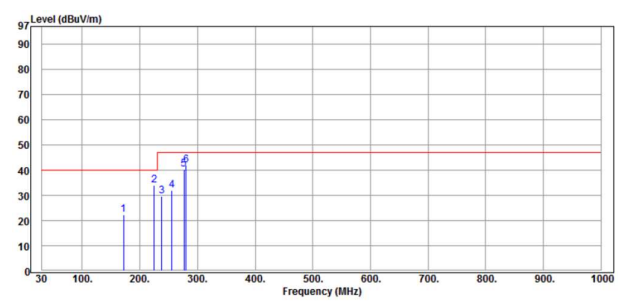

HeadEighths:

14F, No.306, Sec.4, Hsin Yi Rd.
Taipei, Taiwan
Tel: 886-2-27086210
Fax: 886-2-27029852
E-mail: sales@cincon.com
Web Site: <https://www.cincon.com>

CINCON ELECTRONICS CO., LTD.

Factory:

No. 8-1, Fu Kung Rd.
Fu Hsing Industrial Park
Fu Hsing Hsiang,
ChangHua Hsien, Taiwan
Tel: 886-4-7690261
Fax: 886-4-7698031

Cincon North America:

1655Mesa Verde Ave. Ste 180
Ventura, CA93003
Tel: 805-639-3350
Fax: 805-639-4101
E-mail: info@cincon.com